

2015



**STARTERS &  
ALTERNATORS  
SPARE PARTS**

PIÈCES DÉTACHÉES  
ALTERNATEURS  
& DÉMARREURS

**DESPICE DE  
MOTORES DE  
ARRANQUE Y  
ALTERNADORES**

STARTERS &  
ALTERNADORES  
PEÇAS

**PARTI SCIOLTE  
ALTERNATORI  
E MOTORINI**

STARTMOTOR  
EN DYNAMO  
ONDERDELEN

**ANLASSER &  
LICHTMASCHINEN  
ERSATZTEILE**

CZĘŚCI ZAMIENNE  
DO ALTERNATORÓW  
I ROZRUSZNIKÓW

**MARŞ MOTORU  
VE ALTERNATÖR  
YEDEK PARÇALARI**

СОСТАВЛЯЮЩИЕ  
СТАРТЕРА И  
ГЕНЕРАТОРА



**WANT TO  
KNOW MORE?\***



\*en savoir plus

**valeo** added



\*La technologie automobile, naturellement

Automotive technology, naturally\*



EN

## More than 1800 references all covering Valeo technologies

- More than 600 of starter components such as pinion drives, armature, solenoids, brushes and bushing sets.
- More than 1200 of alternators components such as regulators, bearings, rectifier and pulleys including the latest Valeo offer of Free Wheel pulleys.
- Updated catalogue introducing our international range and including TS & FS starters and TG & FG alternators.
- Original Equipment (O.E.) parts, ensuring reliability and safety to get the best performance of your starters and alternators.

FR

## Plus de 1800 références couvrant l'ensemble des technologies Valeo

- Plus de 600 pièces détachées de démarreur dont lanceur, induit, contacteur, jeu de balais et jeu de bagues
- Plus de 1200 pièces détachées d'alternateur dont régulateur, roulement, pont de diodes et incluant la nouvelle offre Valeo sur les poulies roue-libre.
- Un catalogue mis à jour et présentant une gamme internationale incluant les démarreurs TS&FS ainsi que les alternateurs TG&FG
- Pièces de qualité d'origine garantissant fiabilité et sécurité pour des démarreurs et des alternateurs offrant les meilleures performances.

ES

## Más de 1800 referencias Cubren todas las tecnologías Valeo

- Más de 600 componentes de motor de arranque tales como piñón de arranque, inducido, solenoides, escobillas y conjunto de cojinetes.
- Más de 1200 componentes de alternadores tales como reguladores, rodamientos, rectificador y poleas incluye la última oferta Valeo de poleas de rueda libre.
- Catálogo actualizado introduciendo nuestra gama internacional incluye motores de arranque TS & FS y alternadores TG & FG.
- Piezas de Primer Equipo (O.E.), asegurando fiabilidad y seguridad para obtener el mejor rendimiento desus motores de arranques y alternadores.

PT

## Mais de 1800 referências Cobertura de toda a tecnologia Valeo

- Mais de 600 componentes para Motor de Partida como Impulsor, Indutor, Chave Magnética, Porta Escovas, dentre outros.
- Mais de 1200 componentes para Alternador como Regulador, Estator, Ponte Retificadora e Polias incluindo o mais recente lançamento Valeo de Polia de Roda Livre.
- Catálogo atualizado introduzindo nossa gama internacional incluindo tecnologias mais avançadas como as famílias TS e FS para Motores de Partida e TG e FG para Alternadores.
- Componentes Originais de Montadora, garantindo confiança e segurança para obter a melhor performance do seu Motor de Partida e Alternador.

IT

## Più di 1800 riferimenti Copertura di tutta la tecnologia Valeo

- Più di 600 componenti per i motorini di avviamento tra cui Pignone, Armatura, Solenoide, Spazzole e Set di Spazzole
- Più di 1200 componenti per l'alternatore tra cui regolatore, diodi e pulegge inclusa la nuova offerta di Pulegge a Ruota Libera
- Catalogo aggiornato ad introduzione della nostra gamma internazionale inclusi i motorini TS&FS e gli alternatori TG&FG
- Componenti Originali (OE) garanzia di affidabilità e sicurezza per ottenere le migliori performance dai vostri Alternatori e Motorini.

NL

## Meer dan 1800 referenties

- Meer dan 600 startmotor onderdelen zoals pignion, behuizing, solenoiden, borstels
- Meer dan 1200 dynamo onderdelen zoals regelaars, lagers, gelijkrichters, poelies inclusief het laatste aanbod van Valeo; Vrijloop poelies
- Vernieuwde catalogus met wereldwijde introductie van onze range inclusief TS&FS startmotoren en TG&FG dynamo's
- Original onderdelen (O.E. welke betrouwbaarheid en veiligheid garanderen om de beste prestatie van uw startmotoren en dynamo's te verkrijgen

DE

## Mehr als 1800 Referenzen

- Mehr als 600 Anlasser, Ersatzteile so wie Antriebsritzeln, Ankerwelle, Magnete, Schleifbürsten und Bürstenhalter
- Mehr als 1200 Lichtmaschinen, Ersatzteile so wie Regler, Lager, Diodenbrücken und Riemenscheiben. Enthält das aktuellste Valeo Angebot für Generatorfreiläufe
- Der aktualisierte Katalog stellt unser internationales Sortiment dar und enthält die neuen TS & FS Starter und TG & FG Generatoren-Technologien
- Originalteile welche Zuverlässigkeit und Sicherheit gewährleisten um die beste Leistung Ihrer Anlasser und Lichtmaschinen zu erhalten

PL

## Ponad 1800 referencji obejmuje wszystkie technologie Valeo

- Ponad 600 podzespołów do rozruszników takich jak zespoły sprzęgające "bendiks", tworniki, wyłączniki elektromagnetyczne, szczotki, zczotkotrzymacze
- Ponad 600 podzespołów do alternatorów takich jak regulatory napięcia, łożyska, mostki prostownicze czy koła pasowe zawierający najnowszą ofertę kół pasowych ze sprzęgłem jednokierunkowym
- Uaktualniony katalog wprowadzający międzynarodowy zakres zastosowań zawierający rozruszniki typu TS & FS oraz alternatory TG & FG
- Części wyposażenia oryginalnego (O.E.), zapewniające niezawodność i bezpieczeństwo aby uzyskać najlepszą wydajność swoich rozruszników i alternatorów.

TR

## 1800'den fazla referans Hepsi Valeo teknolojisi

- 600'den fazla marş motoru parçası marş dişlisi, kollektör, marş otomatığı, kömür takımı gibi
- 1200'den fazla alternatör parçası konjektörler, rulmanlar, doğrultucular ve kasnaklar gibi Valeo'nun en yeni ürünleri rulmanlı kasnakları da içerir
- Tüm ürünlerimizi içeren güncellenmiş katalog TS & FS marş motorları ile TG & FG alternatörlerin de içerir.

RU

## Более чем 1800 артикулов Технология Valeo

- Более 600 компонентов стартера, такие как обгонная муфта, якорь, втягивающее реле, щетки и наборы щеток
- Более 600 компонентов генератора, такие как регуляторы напряжения, подшипники, выпрямители и шкивы свободного хода, включая последнее предложение Valeo по шкивам
- Обновленный каталог включает международный ассортимент, ассортимент по стартерам TS & FS и генераторам TG & FG
- Запчасти O.E. гарантируют надежность и безопасность, для того, чтобы обеспечить максимальную производительность стартеров и генераторов

BR

## Mais de 1800 referências cobertura de toda a tecnologia Valeo

- Mais de 600 componentes para Motor de Partida
- Como Impulsor, Indutor, Chave Magnética, Porta Escovas, dentre outros.
- Mais de 1200 componentes para Alternador como Regulador, Estator, Ponte Retificadora e Polias incluindo o mais recente lançamento Valeo de Polia de Roda Livre.
- Catálogo atualizado introduzindo nossa gama internacional e incluindo tecnologias mais avançadas como as famílias TS e FS para Motores de Partida e TG e FG para Alternadores.
- Componentes Originais de Montadora, garantindo confiança e segurança para obter a melhor performance do seu Motor de Partida e Alternador.

**1**

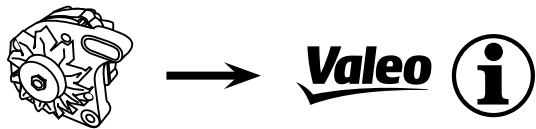

17

**2**

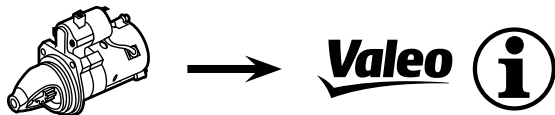

87

**3**

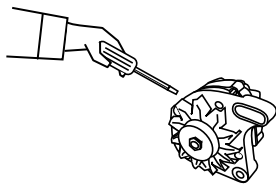

121

**4**

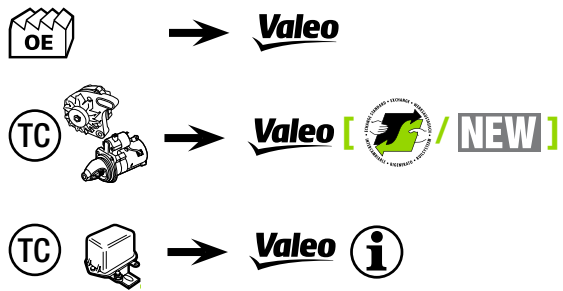

143

# Freewheel pulley range

Turn the wheel, play Valeo!

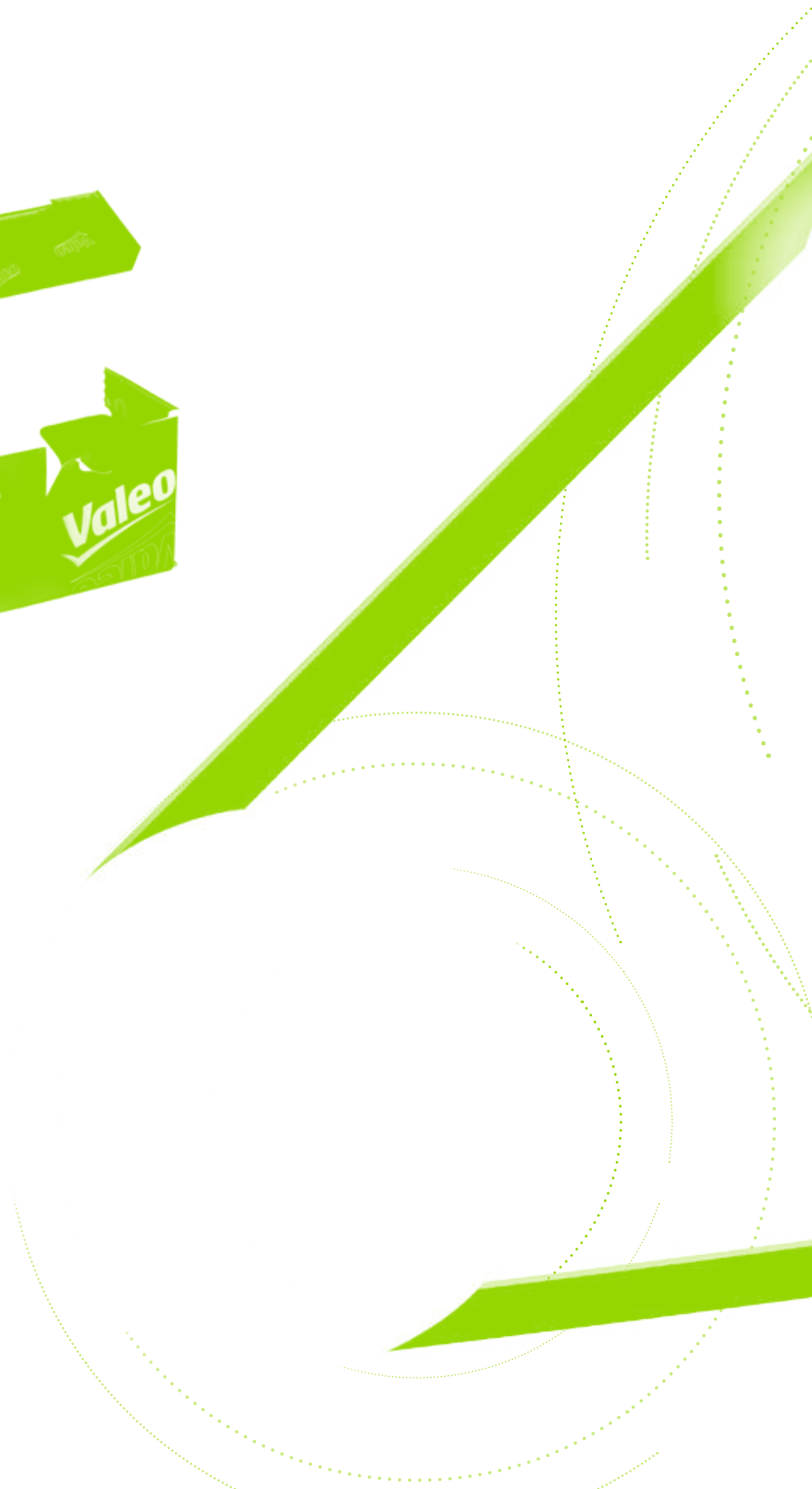

## Electrical Systems Specialist

- 1 out of 3 vehicles are Valeo equipped in Europe
- One stop-shop supplier

## Right product offer

- Overrunning Alternator Pulley
- >100 part numbers
- >14000 worldwide applications
- Valeo branded product

## Quality

tested & certified by Valeo

- Salt spray test
- High-pressure sealing
- Load bearing resistance
- Large temperature differences
- Cycled speeds
- High number of stop and start



## Added value services

- Toolkit for fitting
- Detailed fitting instructions with every part
- Technical assistance:
  - hotline\*
  - valeo-techassist.com\*
  - promoters\*

\*depending on countries

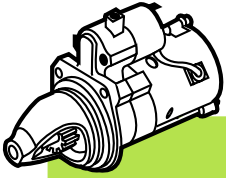

**KW**

**12V**

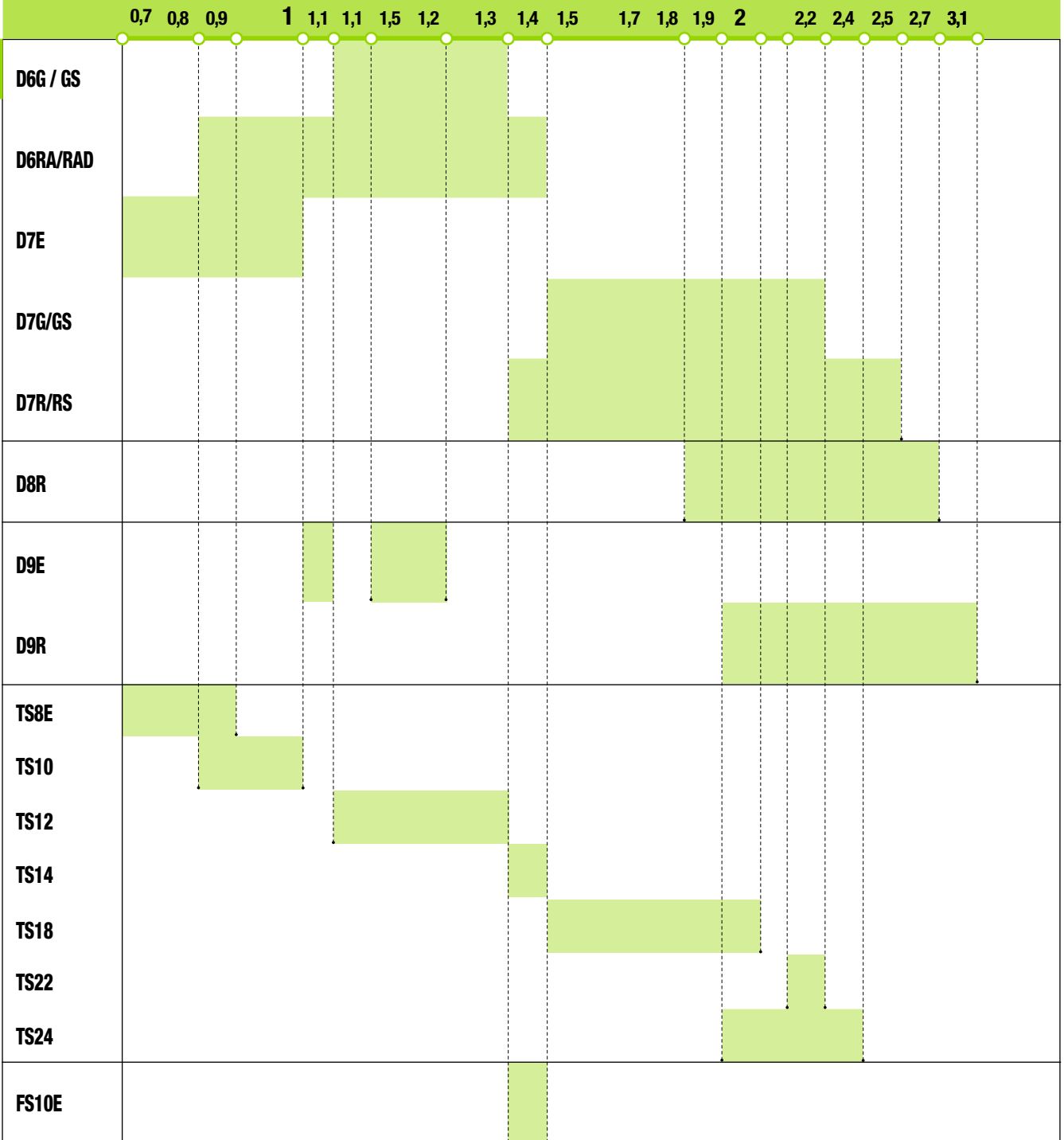

**24V**

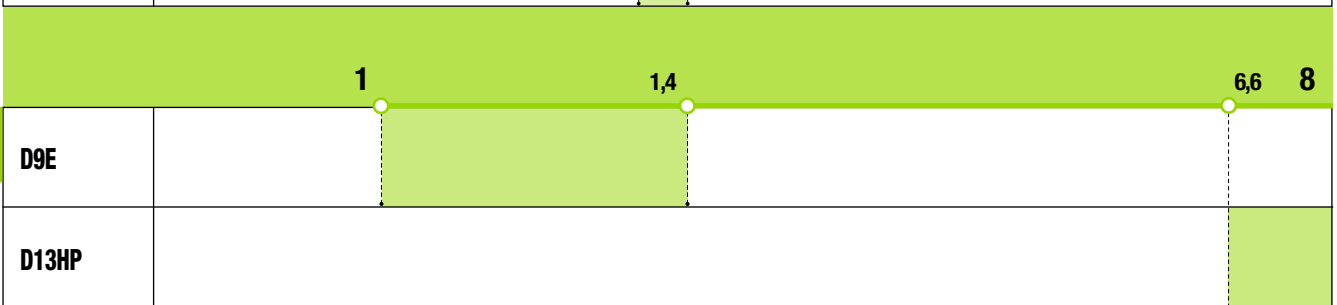

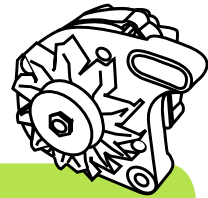

## 14V

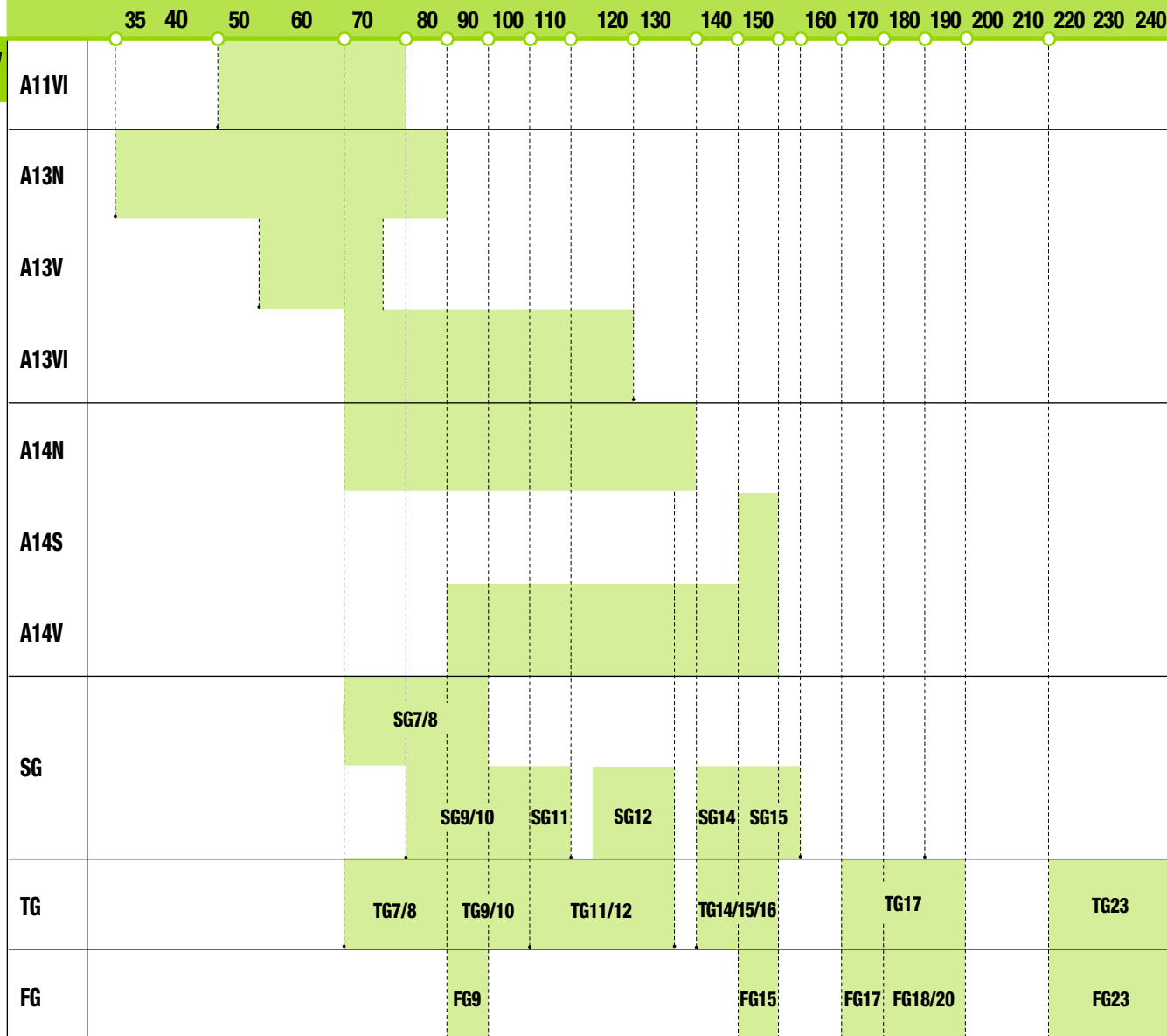

## 28V





# D - 6 - R - A - 33 - T - E

**D**

- Starter
- Demarreur
- Motore de arranque
- Motore de arranque
- Motorini d'avviamento
- Startmotoren
- Anlasser
- Rozrusznik
- Marş motoru
- Стартера
- Motore de arranque

**6**

- Ø cylinder head
- Ø de la culasse
- Ø de la carcasa inductora
- Diámetro da culatra
- Ø della culatta
- Ø Cilinderkop
- Ø Zylinderkopf
- Ø Glowicy
- Ø Gövde çapı
- Ø головки стартера
- Diámetro da culatra

6	7	8	9	10	11	13	15
64 mm	76 mm	85 mm	92 mm	100 mm	110 mm	130 mm	150 mm

**R**

**G/R :**

- Reduction gears
- Reducteur
- Reductor
- Reductor
- Reductor
- Riduttore
- Reductie tandwielen
- Untersetzungsgetriebe
- Przekładnia redukcyjna
- Şanzıman
- Молю стартера
- Reductor

**A**

**A :**

- Permanent magnets
- Aimants permanents
- Imanes permanentes
- Ímanes permanentes
- Magneti permanenti
- Permanente magneten
- Ständige Magnete
- Magnesij stale
- Sürekli mıknatıs
- Постоянные магниты
- Ímanes permanentes

**S :**

- Pre-engaged starter without nose à bracket
- Pignon sortant
- Piñón saliente
- Pinhão saliente
- Pignone uscente
- Starter zonder eigen neuslager
- Fremdgelagert
- Czolowo montowany bez glowicy
- Açık pinyon karađı
- Стартер крелен корпусом (без головки)

**B :**

- Bendix Drive
- Lanceur à inertie (Bendix)
- Piñón de arranque de inercia
- Pinhão de arranque
- Bendix
- Pignone ad inerzia (Bendix)
- Massatragheidsrondsel (Bendix)
- Trägheitantriebsritzel
- Zębnik
- Bendix dişlisi
- Инерционный приод
- Pinhão de arranque

**E :**

- Electromagnetic contactor
- Contacteur électromagnétique
- Relé contactor electromagnético
- Relé electromagnético
- Contattore elettromagnetico
- Elektromagnetische schakelaar
- Elektromagnetischer Magnetschalter
- Elektromagnetyczny włącznik
- Elektromanyetik kontaktör
- Электромагнитный контакт
- Relé electromagnético

**L :**

- Pinion fork
- Lanceur à commande positive
- Piñón de arranque de accionamiento positivo
- Pinhão de arranque de acionamento positivo
- Pignone a comando positivo
- Positieve rondselbediening/ rondselvork
- Antriebsritzel mit positiver Bedienung
- Dźwigienka zębnika dodatnia
- Marş çatalı
- Вилка
- Pinhão de arranque de acionamento positivo

**33**

- Research dept. nr. of order
- N° d'ordre du bureau d'études
- Numero de orden de las oficinas de investigación
- Número de ordem do gabinete de investigação
- Numero d'ordine dell'ufficio di ricerca
- Permanente magneten
- Nummersfolge des technischen Planungsbüro
- Numer zamówienia ośrodka badawczego
- Arge sipariş numarası
- Номер заказа центра Вальео
- Número de ordem do gabinete de investigação

**T**

- Tropicalised (varnished)
- Tropicalisé (verniz antifongique)
- Tropicalizado (barniz antihongos)
- Tropicalizado
- Tropicalizzato (vernice antimuffa)
- Tropenbestendig (gelakt)
- Tropenfest (lakiert)
- Tropik (lakierowany)
- Sıcak iklim için (vernikli)
- Покрyтый Лаком (для работы в жарком климате)
- Tropicalizado

**E**

- Waterproof
- Etanche aux projections
- Estanco a las proyecciones
- Estanque às projecções
- Stagno ai getti d'acqua
- Waterdicht
- Wasserdicht
- Podwyższona szczelność
- Su geçirmez
- Водонепроницаемый
- Estanque às projecções



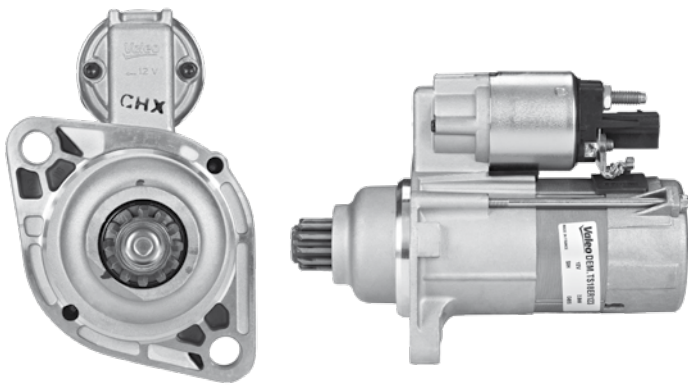

# TS - 18 - E - R - 123

**TS**

<b>T</b>	<ul style="list-style-type: none"> <li>• Third generation</li> <li>• Troisième génération</li> <li>• Tercera generaci3n</li> </ul>	<ul style="list-style-type: none"> <li>• Terceira gera33o</li> <li>• Terza generazione</li> <li>• Derde generatie</li> </ul>	<ul style="list-style-type: none"> <li>• Dritte Generation</li> <li>• Trzecia generacja</li> <li>• Uçüncü nesil</li> </ul>	<ul style="list-style-type: none"> <li>• Третье поколение</li> <li>• Terceira geraç3o</li> </ul>
<b>F</b>	<ul style="list-style-type: none"> <li>• Fourth generation</li> <li>• Quatrième génération</li> <li>• Cuarta generaci3n</li> </ul>	<ul style="list-style-type: none"> <li>• Quarta geraç3o</li> <li>• Quarta generazione</li> <li>• Vierde generatie</li> </ul>	<ul style="list-style-type: none"> <li>• Vierte Generation</li> <li>• Czwarta generacja</li> <li>• Dördüncü nesil</li> </ul>	<ul style="list-style-type: none"> <li>• Четвертое поколение</li> <li>• Quarta geraç3o</li> </ul>
<b>C</b>	<ul style="list-style-type: none"> <li>• Fifth generation</li> <li>• Cinquième génération</li> <li>• Quinta generaci3n</li> </ul>	<ul style="list-style-type: none"> <li>• Quinta geraç3o</li> <li>• Quinta generazione</li> <li>• Vijfde generatie</li> </ul>	<ul style="list-style-type: none"> <li>• Fünfte Generation</li> <li>• Piąta generacja</li> <li>• Beşinci Nesil</li> </ul>	<ul style="list-style-type: none"> <li>• Пятое поколение</li> <li>• Quinta geraç3o</li> </ul>
<b>E</b>	<ul style="list-style-type: none"> <li>• "ReStarter" (Reinforced Starter)</li> <li>• Démarreur renforcé</li> <li>• Motor de arranque reforzado</li> <li>• Motor de arranque reforçado</li> </ul>	<ul style="list-style-type: none"> <li>• "ReStarter" (Motorino Rinforzato)</li> <li>• "ReStarter" (Reinforced Starter)</li> <li>• "ReStarter" (Verstärkter Starter)</li> </ul>	<ul style="list-style-type: none"> <li>• "ReStarter" (rozsusznik wzmacniony)</li> <li>• "Restarter"(Güçlendirilmiş marş motoru)</li> </ul>	<ul style="list-style-type: none"> <li>• "ReStarter" (Усиленный стартер)</li> <li>• Motor de arranque reforçado</li> </ul>
<b>L</b>	<ul style="list-style-type: none"> <li>• Light (Starter)</li> <li>• Léger</li> <li>• Ligero</li> </ul>	<ul style="list-style-type: none"> <li>• Ligeiro</li> <li>• Leggero</li> <li>• Light (starter)</li> </ul>	<ul style="list-style-type: none"> <li>• Optimierter Starter</li> <li>• Światło (rozsusznik)</li> <li>• Light (Marş Motoru)</li> </ul>	<ul style="list-style-type: none"> <li>• Облегченный (стартер)</li> <li>• Ligeiro</li> </ul>

**18**

<b>(KW)</b>	<b>8</b> = 0,8	<b>14</b> = 1,4	<b>22</b> = 2,2	<b>50</b> = 5,0
	<b>10</b> = 1,0	<b>18</b> = 1,8	<b>24</b> = 2,4	<b>60</b> = 6,0
	<b>12</b> = 1,2	<b>20</b> = 2,0		

**E**

<b>B</b> = Brazil	<b>K</b> = Korea	<b>N</b> = Mexico
<b>E</b> = Europe	<b>M</b> = India	<b>C</b> = China

**R**

<b>Ø</b>	<ul style="list-style-type: none"> <li>• Standard Design</li> <li>• Design standard</li> <li>• Diseño estandar</li> </ul>	<ul style="list-style-type: none"> <li>• Projeto padrão</li> <li>• Disegno standard</li> <li>• Standaard design</li> </ul>	<ul style="list-style-type: none"> <li>• Standard Design</li> <li>• Standardowa konstrukcja</li> </ul>	<ul style="list-style-type: none"> <li>• Standart dizayn</li> <li>• Стандартный дизайн</li> <li>• Projeto padrão</li> </ul>
<b>R</b>	<ul style="list-style-type: none"> <li>• Recessed pinion (VW engines)</li> <li>• Pignon sortant</li> <li>• Piñ3n saliente (Motores VW)</li> </ul>	<ul style="list-style-type: none"> <li>• Pinh3o de saída (motores VW)</li> <li>• Pignone ad incasso</li> <li>• Verzonken rondsel</li> <li>• Freiausstoßend</li> </ul>	<ul style="list-style-type: none"> <li>• (VW Motoren)</li> <li>• Wpuszczany zębnik (silniki VW)</li> <li>• Gizli Pinyon (VW motoru)</li> </ul>	<ul style="list-style-type: none"> <li>• Утопленная обгонная муфта (двигатели VW)</li> <li>• Pinh3o de saída (motores VW)</li> </ul>
<b>PR</b>	<ul style="list-style-type: none"> <li>• Pre-Rotation</li> <li>• Pré-Rotation</li> <li>• Pre-rotaci3n</li> </ul>	<ul style="list-style-type: none"> <li>• Pré rotaç3o</li> <li>• Pre-Rotazione</li> <li>• Pre-Rotatie</li> </ul>	<ul style="list-style-type: none"> <li>• Vordrehend</li> <li>• Obr3t wstępný</li> <li>• Tek yön dönüşlü</li> </ul>	<ul style="list-style-type: none"> <li>• Предварительная раскрутка</li> <li>• Pré rotaç3o</li> </ul>
<b>PE</b>	<ul style="list-style-type: none"> <li>• Pre-Engaged</li> <li>• Pré-engagement</li> <li>• Pre-enganche</li> </ul>	<ul style="list-style-type: none"> <li>• Pré-contratado</li> <li>• Pre-Innestato</li> <li>• Voorgeschakeld</li> </ul>	<ul style="list-style-type: none"> <li>• Schubschraubstarter</li> <li>• Wzbudzony wstępnie</li> <li>• Sabit yönlü</li> </ul>	<ul style="list-style-type: none"> <li>• Стартер постоянного зацепления</li> <li>• Pré-contratado</li> </ul>
<b>M</b>	<ul style="list-style-type: none"> <li>• Permanent Magnets</li> <li>• Aimants permanents</li> <li>• Imanes permanentes</li> </ul>	<ul style="list-style-type: none"> <li>• Íman permanentes</li> <li>• Magneti Permanenti</li> <li>• Permanente Magneten</li> </ul>	<ul style="list-style-type: none"> <li>• Dauermagnet</li> <li>• Magnesy stałe</li> <li>• Kalıcı Miknatıslar</li> </ul>	<ul style="list-style-type: none"> <li>• ТПостоянные магниты</li> <li>• Íman permanentes</li> </ul>
<b>W</b>	<ul style="list-style-type: none"> <li>• Wound fields</li> <li>• Aimants bobinés</li> <li>• Bobinas inductoras</li> </ul>	<ul style="list-style-type: none"> <li>• Bobinas de induç3o</li> <li>• Campi Bobine</li> <li>• Velden</li> </ul>	<ul style="list-style-type: none"> <li>• Magnetschalter</li> <li>• Obszary uzwojenia</li> <li>• Sarılı Bobinler</li> </ul>	<ul style="list-style-type: none"> <li>• Двухобмоточные</li> <li>• Bobinas de induç3o</li> </ul>

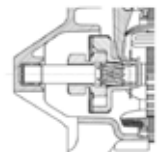

Ø

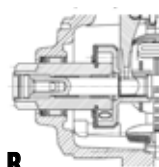

R

**123**

<ul style="list-style-type: none"> <li>• Research dept. nr. of order</li> <li>• N° d'ordre du bureau d'études</li> <li>• Numero de orden de las oficinas de investigaci3n</li> </ul>	<ul style="list-style-type: none"> <li>• Número de ordem do gabinete de investigaç3o</li> <li>• Numero d'ordine dell'ufficio di ricerca</li> <li>• Permanente magneten</li> </ul>	<ul style="list-style-type: none"> <li>• Nummersfolge des technischen Planungsbüro</li> <li>• Numer zamówienia ośrodka badawczego</li> <li>• Arge sipariş numarası</li> </ul>	<ul style="list-style-type: none"> <li>• Номер заказа центра Вальео</li> <li>• Número de ordem do gabinete de investigaç3o</li> </ul>
--	---	---	---



# A - 13 - VI - 273 - M/T

**A**

- Alternator
- Alternateur
- Alternadore

- Alternadore
- Alternatori
- Dynamo

- Lichtmaschine
- Alternator
- Alternatör

- Генератор
- Alternadore

- SG :**
- Second generation
  - Seconde génération

- Segunda Generación
- Segunda geração
- Seconda generazione

- Tweede generatie
- Zweite Generation
- Druga generacja

- İkinci kuşak
- второе поколение
- Segunda geração

- TG :**
- Third generation
  - Troisième génération

- Tercera Generación
- Terceira geração
- Terza generazione

- Dritte generatie
- Dritte Generation
- Trzecia generacja

- Üçüncü kuşak
- третье поколение
- Terceira geração

**13**

- Ø cylinder head
- Ø de la culasse
- Ø de la carcasa inductora

- Diâmetro da culatra
- Ø della culatta
- Ø Cilinderkop

- Ø Zylinderkopf
- Ø Glowicy
- Ø Gövde çapı

- Ø головки стартера
- Diâmetro da culatra

11	12	13	14	16
110 mm	120 mm	130 mm	140 mm	160 mm

**VI**

- N :**
- Triphase (current version)
  - Triphase (version actuelle)
  - Trafico (versión actual)

- Trifásico (versão actual)
- Trifase (versione attuale)
- Drie fasen (huidige versie)

- Dreiphasig (jetzige Version)
- Trójfazowy (wersja obecna)
- Trifaze (yaygın uygulama)

- трехфазный (даная версия)
- Trifásico (versão actual)

- E :**
- Triphase (export version)
  - Triphase (version export)
  - Trafico (versión export)

- Trifásico (versão de exportação)
- Trifase (versione export)
- Drie fasen (export versie)

- Dreiphasig (Exportversion)
- Trójfazowy (wersja export)
- Trifaze (ihrac uyarlamasi)

- трехфазный (экспортная версия)
- Trifásico (versão de exportação)

- V :**
- Triphase (Mercedes - BMW)
  - Triphase (Mercedes - BMW)
  - Trafico (Mercedes - BMW)

- Trifásico (BMW - Mercedes)
- Trifase (Mercedes - BMW)
- Drie fasen (Mercedes - BMW)

- Dreiphasig (Mercedes - BMW)
- Trójfazowy (Mercedes - BMW)
- Trifaze (Mercedes - BMW)

- трехфазный (Mercedes - BMW)
- Trifásico (BMW - Mercedes)

- G :**
- Triphase (older version)
  - Triphase (ancienne version)
  - Trifásico (versión antigua)

- Trifásico (versão antiga)
- Trifase (versione precedente)
- Drie fasen (oudere versie)

- Dreiphasig (frühere Version)
- Trójfazowy (wersja starsza)
- Triphase (eski uyarlama)

- трехфазный (устаревшая версия)
- Trifásico (versão antiga)

- M :**
- Single-phase
  - Monophase

- Monofásico
- Monofásico
- Monofase

- Dreiphasig (frühere Version)
- één fase

- Jednofazowy
- однофазный
- Monofásico

**273**

- Research dept. nr. of order
- N° d'ordre du bureau d'études
- Numero de orden de las oficinas de investigación

- Número de ordem do gabinete de investigação
- Numero d'ordine dell'ufficio di ricerca

- Permanente magneten
- Nummersfolge des technischen Planungsbüro
- Numer zamówienia ośrodka badawczego

- Arge siparifi numarasi
- Номер заказа центра Валео
- Número de ordem do gabinete de investigação

**M/T**

**M :** Marine (protected brush holders and marinised)

**T :** Tropicalised (varnished)

**M :** Marine (porte balais protégé et traitement alodine)

**T :** Tropicalise (vernis anti fongique)

**M :** Marinizado (porta escobillas protegido y tratado)

**T :** Tropicalizado

**M :** Marinizado (porta-escovas protegido e tratado)

**T :** Tropicalizado

**M :** Marine (beschermde borstelhouder en behandeld)

**T :** Tropenbestendig (gelakt)

**M :** Marine

**T :** Tropenfest

**M :** Morski (zabezpieczone szczotki i podwyższona szczelność)

**T :** Tropik (lakierowany)

**M :** Deniz ürünü (Korunmuş kömür tutucusu)

**T :** Sıcak iklim için (vernikli)

**M :** морской (специально защищенные щеткодержатели)

**T :** Покрытый лаком (для работы в жарком климате)

**M :** Marinizado (porta-escovas protegido e tratado)

**T :** Tropicalizado

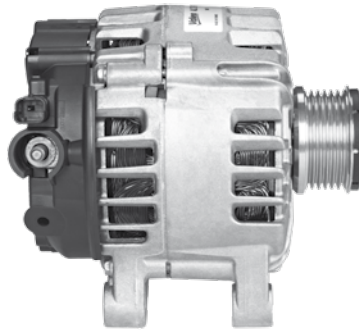

# FG - 18 - S - 027

**FG**

<b>T</b>	<ul style="list-style-type: none"> <li>• Third generation</li> <li>• Troisième génération</li> <li>• Tercera generaci3n</li> </ul>	<ul style="list-style-type: none"> <li>• Terceira gera33o</li> <li>• Terza generazione</li> <li>• Derde generatie</li> </ul>	<ul style="list-style-type: none"> <li>• Dritte Generation</li> <li>• Trzecia generacja</li> <li>• Üçüncü nesil</li> </ul>	<ul style="list-style-type: none"> <li>• Третье поколение</li> <li>• Terceira gera33o</li> </ul>
<b>F</b>	<ul style="list-style-type: none"> <li>• Fourth generation</li> <li>• Quatrième génération</li> <li>• Cuarta generaci3n</li> </ul>	<ul style="list-style-type: none"> <li>• Quarta gera33o</li> <li>• Quarta generazione</li> <li>• Vierde generatie</li> </ul>	<ul style="list-style-type: none"> <li>• Vierte Generation</li> <li>• Czwarta generacja</li> <li>• Dördüncü nesil</li> </ul>	<ul style="list-style-type: none"> <li>• Четвертое поколение</li> <li>• Quarta gera33o</li> </ul>
<b>C</b>	<ul style="list-style-type: none"> <li>• Fifth generation</li> <li>• Cinquième génération</li> <li>• Quinta generaci3n</li> </ul>	<ul style="list-style-type: none"> <li>• Quinta gera33o</li> <li>• Quinta generazione</li> <li>• Vijfde generatie</li> </ul>	<ul style="list-style-type: none"> <li>• Fünfte Generation</li> <li>• Piąta generacja</li> <li>• Beşinci Nesil</li> </ul>	<ul style="list-style-type: none"> <li>• Пятое поколение</li> <li>• Quinta gera33o</li> </ul>
<b>E</b>	<ul style="list-style-type: none"> <li>• Efficient</li> <li>• Efficace</li> <li>• Eficiente</li> </ul>	<ul style="list-style-type: none"> <li>• Eficiente</li> <li>• Efficiente</li> <li>• Efficient</li> </ul>	<ul style="list-style-type: none"> <li>• Effizient</li> <li>• Wydajność</li> <li>• Verim</li> </ul>	<ul style="list-style-type: none"> <li>• Эффективная</li> <li>• Eficiente</li> </ul>

**18**

<b>A</b>	<ul style="list-style-type: none"> <li><b>7</b> = 70</li> <li><b>8</b> = 80</li> <li><b>9</b> = 90</li> </ul>	<ul style="list-style-type: none"> <li><b>10</b> = 100</li> <li><b>12</b> = 120</li> <li><b>15</b> = 150</li> </ul>	<ul style="list-style-type: none"> <li><b>18</b> = 180</li> <li><b>20</b> = 200</li> <li><b>22</b> = 220</li> </ul>	<ul style="list-style-type: none"> <li><b>23</b> = 230</li> <li><b>25</b> = 250</li> </ul>
----------	---	---	---	--

**S**

<b>B</b>	<ul style="list-style-type: none"> <li>• Clamps</li> <li>• Pincas</li> <li>• Abrazadera</li> </ul>	<ul style="list-style-type: none"> <li>• Abraçadeira</li> <li>• Morsetti</li> <li>• Klemmen</li> </ul>	<ul style="list-style-type: none"> <li>• Klammern</li> <li>• Zaciski</li> <li>• Kenetlemek</li> </ul>	<ul style="list-style-type: none"> <li>• Зажимы</li> <li>• Abraçadeira</li> </ul>
<b>S</b>	<ul style="list-style-type: none"> <li>• Sandwich</li> <li>• Sandwich</li> <li>• Sandwich</li> </ul>	<ul style="list-style-type: none"> <li>• Sandwich</li> <li>• Sandwich</li> <li>• Sandwich</li> </ul>	<ul style="list-style-type: none"> <li>• Sandwichbauweise</li> <li>• Sandwich</li> <li>• Sandviç</li> </ul>	<ul style="list-style-type: none"> <li>• Многослойный</li> <li>• Sandwich</li> </ul>
<b>C</b>	<ul style="list-style-type: none"> <li>• Statcol™</li> <li>• Statcol™</li> <li>• Statcol™</li> </ul>	<ul style="list-style-type: none"> <li>• Statcol™</li> <li>• Statcol™</li> <li>• Statcol™</li> </ul>	<ul style="list-style-type: none"> <li>• Statcol™</li> <li>• Statcol™</li> <li>• Statcol™</li> </ul>	<ul style="list-style-type: none"> <li>• Statcol™</li> <li>• Statcol™</li> </ul>
<b>L</b>	<ul style="list-style-type: none"> <li>• Liquid / Watercooled</li> <li>• Refroidissement liquide</li> <li>• Líquido / Refrigerado por agua</li> </ul>	<ul style="list-style-type: none"> <li>• Líquido / Refrigerado pela água</li> <li>• Raffreddato ad acqua</li> <li>• Watergekoeld</li> </ul>	<ul style="list-style-type: none"> <li>• Wassergekühlt</li> <li>• Chłodzony cieczą</li> <li>• Sıvı / Su soğutmalı</li> </ul>	<ul style="list-style-type: none"> <li>• Жидкость / Охлаждение водой</li> <li>• Líquido / Refrigerado pela água</li> </ul>
<b>D</b>	<ul style="list-style-type: none"> <li>• No magnets (specific FG)</li> <li>• Sans aimants (spécifique FG)</li> <li>• Sin imanes ( FG específico)</li> </ul>	<ul style="list-style-type: none"> <li>• Sem íman (FG específico)</li> <li>• Privo di magneti</li> <li>• Geen magneten (FG)</li> </ul>	<ul style="list-style-type: none"> <li>• Keine Magnete (FG)</li> <li>• Bezmagnesowy (dotyczy FG)</li> <li>• Miknatissız (FG için özel)</li> </ul>	<ul style="list-style-type: none"> <li>• Без магнитов (особый FG)</li> <li>• Sem íman (FG específico)</li> </ul>
<b>T</b>	<ul style="list-style-type: none"> <li>• Tri-phase</li> <li>• Tri-phasé</li> <li>• Tri-fase</li> </ul>	<ul style="list-style-type: none"> <li>• Trifásica</li> <li>• Tri-fase</li> <li>• 3-fase</li> </ul>	<ul style="list-style-type: none"> <li>• Dreiphasig</li> <li>• Trójfazowy</li> <li>• Üç faz</li> </ul>	<ul style="list-style-type: none"> <li>• Трёхфазный</li> <li>• Trifásica</li> </ul>

**027**

<ul style="list-style-type: none"> <li>• Research dept. nr. of order</li> <li>• N° d'ordre du bureau d'études</li> <li>• Numero de orden de las oficinas de investigación</li> </ul>	<ul style="list-style-type: none"> <li>• Número de ordem do gabinete de investigação</li> <li>• Numero d'ordine dell'ufficio di ricerca</li> </ul>	<ul style="list-style-type: none"> <li>• Permanente magneten</li> <li>• Nummersfolge des technischen Planungsbüro</li> <li>• Numer zamówienia ośrodka badawczego</li> </ul>	<ul style="list-style-type: none"> <li>• Arge siparifi numarasi</li> <li>• Нопер заказа центра Валео</li> <li>• Número de ordem do gabinete de investigação</li> </ul>
--	--	---	--

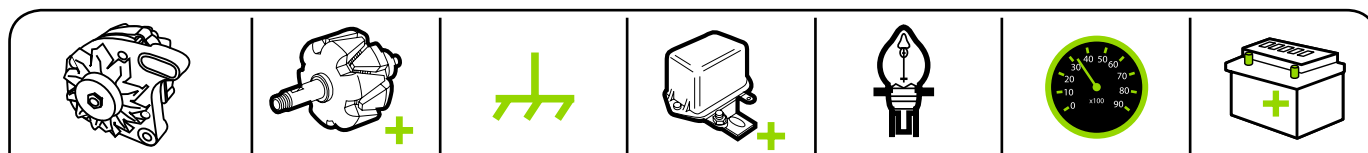
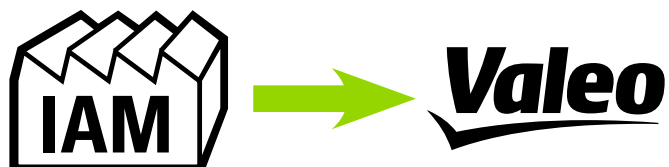

<b>VALEO</b>	Exc	B-	D+	D+	W	B+
<b>DUCELLIER</b>	Exc	D-	+R	L	W	B+
<b>VALEO</b>	F	E	IG/R	L/I	P	B/A
<b>MOTOROLA</b>	Exc	-	+	D+	W	B+
<b>PARIS-RHÔNE</b>	Exc	M	61+	+A/L	R	+
<b>SEV MARCHAL</b>	DF	-	61+			B
<b>BOSCH</b>	DF	D-	D+	D+61/L	W	B+
<b>DELCO-REMY</b>	F	GRD	+	D+/L/1	P/R/W	B+
<b>ELMOT</b>	67	31		15	W	B+
<b>FEMSA</b>	EXC	31	+			
<b>HITACHI</b>	F	E	IG	L	P	B/A
<b>ISKRA</b>	DF	D-		D+	W	B+
<b>LUCAS</b>	F	-	D+	I.N.D.	S.T.A.	B+
<b>MAGNETI MARELLI</b>	67	31		15	W	B+/30
<b>MITSUBISHI</b>	F	E	IG/R	L	P	B/A
<b>NOPPONDENSO</b>	F	E-	IG/R	L	P	B/A
<b>PAL MAGNETON</b>	M	E-		R		B+
<b>VISTEON</b>	DF/F/FLD	D-/VE		D+/I.N.D./I	W/S.T.A./S	B+/BAT

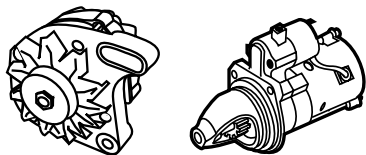

	Amps Ampérage Amperaje	Amperes Amperaggio Ampère	Ampere Amper Amperaj	Амперы Амперес
--	------------------------------	---------------------------------	----------------------------	-------------------

	Insulated earth Masse isolée Masa aislada	Massa isolada Massa isolata Geïsoleerde massa	Isolierte Masse Izolowana masa Yalıtımlı eksi uç	Заземление Terra/Massa isolada
--	---	---	--	--------------------------------------

	Output at 3000 RPM Point à 3000 tr/mn Carga a 3000 r.p.m.	Carga a 3000 r.p.m. Carica a 3000 giri/min Vermogen bij 3000 tpm	Leistung bei 3000 U/min Nateżenie przy 3000 obr/min 3000 devir/dakikada üretim	Выход на 3000 оборотов в минуту Carga a 3000 r.p.m.
--	--	--	---	--

	Output at 8000 RPM Point à 8000 tr/mn Carga a 8000 r.p.m.	Carga a 8000 r.p.m. Carica a 8000 giri/min Vermogen bij 8000 tpm	Leistung bei 8000 U/min Nateżenie przy 8000 obr/min 8000 devir/dakikada üretim	Выход на 8000 оборотов в минуту Carga a 8000 r.p.m.
--	--	--	---	--

	Regulator type Type de régulateur Tipo de regulador	Tipo de regulador Tipo di regolatore Type regelaar	Regler-Typ Typ regulatora Konjektör türü	Тип регулятора Tipo de regulador
--	---	--	--	-------------------------------------

	RPM Cut in speed Vitesse d'amorçage tr/mn Comienzo de carga r.p.m.	Começo de carga r.p.m. Toerenbegrenzing in tpm Anlassdrehzahl	Obr/min początek ładowania Obr/min początek ładowania Elektrik üretebilme eşik devri tr/dak	Скорость оборотов в минуту Começo de carga r.p.m.
--	--	---	--	--

	Regulator connection Alimentation régulateur Alimentación regulador	Alimentação do regulador Alimentazione regolatore Spanningsregelaar	Stromversorgung, Regler Podłączenie regulatora Konjektör besleme bağlantısı	Соединитель регулятора Alimentação do regulador
--	---	---	--	--

	Rotor connection Alimentation rotor Alimentación rotor	Alimentação do rotor Alimentazione rotore Rotorspanning	Stromzuführung Rotor Podłączenie wirnika Rotor besleme bağlantısı	Соединитель ротора Alimentação do rotor
--	--	--	---	--

	Warning lamp Lampe témoin Lámpara testigo	Lámpada de aviso Spia di avviso Controlelampje	Kontrolllampe Lampka sygnali- zacyjna	İkaz lambası Сигнал тревоги Lámpada de aviso
--	---	--	---	--

	Mass Masse Masa	Massa Massa Massa	Masse Masa Kutup	Масса Massa
--	-----------------------	-------------------------	------------------------	----------------

	Direct current outflow Sortie + courant Salida de corriente +	Saída de corrente + Uscita corrente continua Hoofdstroomuitgang	Plusanschluss Właściwe ujęcie Direkt akım çıkış	Постоянный ток Saída de corrente
--	--	--	---	-------------------------------------

	Alternative outflow Sortie alternative Salida alternativa W	Saída alternativa W Uscita alternata Alternatieve stroomuitgang	Alternativausgang (Stromausgang) Alternatywne ujęcie Alternatif akım çıkış	Переменный ток Saída alternativa
--	---	--	---	-------------------------------------

	Number of teeth Nombre de dents Número de dientes	Número de dentes Numero di denti Aantal tanden	Anzahl der Zähne Liczba zębów Diş sayısı	Количество зубьев Número de dentes
--	---	--	--	---------------------------------------

	Power Puissance Potencia	Potência Potenza Vermogen	Leistung Moc Güç	Питание Potência
--	--------------------------------	---------------------------------	------------------------	---------------------

	Technical code Code technique Código técnico	Código técnico Codice tecnico Technische code	Technischer Code Kod techniczny Teknik kod	Техический код Código técnico
--	--	---	--	----------------------------------

	Connection Connecteur Conector	Conector Connettore Connector	Stecker Złącze Bağlantı	Соединение Conector
--	--------------------------------------	-------------------------------------	-------------------------------	------------------------

	DS : two senses DS : deux sens DS : Doble Sentido	DS : Duplo sentido DS: due sensi DS: twee richtingen	DS: Doppelrichtung DS. : dwukierunkowy DS : İki yöne	ПТ: два направления / потока DS: Duplo sentido
--	---	--	--	---

	Measurements after repair Mesures après réparation Medidas después de la reparación	Medidas depois da reparação Misura dopo la riparazione Afmetingen na de reparatie	Abmessungen nach der Reparatur Pomiar po naprawie Tamir sonrası ölçüler	Замеры после ремонта Medidas depois da reparação
--	--	--	---	---

	Rotation direction Sens de rotation Sentido de rotación	Sentido de rotação Senso di rotazione Draairichting	Drehrichtung Kierunek rotacji Dönme yönü	Направление вращения Sentido de rotação
--	---	---	--	---

	Clockwise SH: Sens horaire Rotación en el sentido de las agujas del reloj	Rotação no sentido dos ponteiros dos relógio Senso orario Met de klok mee	Drehrichtung: Im Uhrzeigersinn Prawostronny Saat yönüne	По часовой стрелке Rotação no sentido horário
--	---	---	--	--

	Anti-clockwise SIH : Sens antihoraire Rotación en el sentido inverso de las agujas anti-horário del reloj	Rotação no sentido contrário dos ponteiros dos relógio Senso anti-orario Tegen de klok in	Drehrichtung: Entgegen dem Uhrzeigersinn Lewostronny Saat yönü tersine	Против часовой стрелки Rotação no sentido anti-horário
--	--	--	--	---

	Voltage Tension Tensión	Tensão Tensione Spanning	Spannung Napięcie Voltaj	Напряжение Tensão
--	-------------------------------	--------------------------------	--------------------------------	----------------------

	Supplier manufacturer P/N Code équipementier Códigos otras marcas	Códigos de outras marcas Riferimenti concorrenti OES nummer fabrikant	Herstellernummer Numer katalogowy dostawcy Sağlayıcı parça numarası	Артикул поставщика Códigos outras marcas
--	---	--	---	---

	Assembly instructions Notices de montage Instrucciones de montaje	Instruções de montagem Istruzioni di montaggio Montage-instructie	Einbauanleitung Kompletna ins- trukcja montażu Takma talimatları	Инструкция по сборке Instrução de montagem
--	---	---	---	---

	Spare parts & burst drawings Pièces détachées & verves éclatées Despiece y dibujos detallados	Desmontagem e desenhos detalhados Parti sciolte e vista esplosa Onderdelen en technische	tekening Ersatzteil und Explosionszeichnung Części zamienne i rysunki przekrojowe	Yyedek parça ve açılım çizimleri Запчасти и чертежи Componentes e vista explodida
--	--	--	---	--

	OE manufacturer part number Référence constructeur	Referencia constructor Referência construtor Riferimenti costruttore	OE nummer fabrikant OE-Artikelnummer Numer katalogowy producenta	Араç üreticisi parça numarası Артикул O.E. Código Montadora
--	---	--	--	--

	Tin welding Soudure à l'étain Soldadura de estaño	Soldadura a estanho Saldatura a stagno Gesoldeerd met tin	Weichlötlung Lutowanie cyną Lehim	Пайка оловом Soldadura a estanho
--	--	--	---	--

	Electrical welding Soudure électrique Soldadura eléctrica	Soldadura eléctrica Saldatura elettrica Electrische gelast	Elektrische Schweißung Lutowanie elektryczne	Elektrik kaynağı Электросварка Soldadura eléctrica
--	---	--	---	--

	Fixing angle Angle et position de montage Angulo de montaje	Ângulo de montagem Angolo e posizione di montaggio Montage hoek	Winkelstellung Kąt i pozycja montażu Montaj açısı	Анкерное крепление Ângulo de montagem
--	--	---	--	--

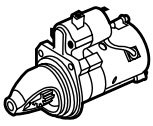
**02**

Armature  
Induit  
Inducido  
Induzido

Armatura  
Anker  
Ankerwelle  
Twornik

Kollektör  
Якорь  
Induzido

**02a**

Reduction gear  
assembly  
Moto réducteur complet  
Moto reductor completo  
Moto reductor completo  
Motoriduttore completo

Reductieinrichting  
compleet  
Untersetzungegetriebe,  
komplett  
Przekładnia  
redukcyjna kpl.

Şanzıman sargı  
kollektör takımı  
Модуль стартера в  
сборе  
Moto reductor completo

**03**

Pinion Drive  
Lanceur  
Piñón de arranque  
Pinhão de arranque

Pignone  
Rondsel  
Antriebsritzel  
Zębnik

Marş dişlisi  
Бендикс  
Impulsor

**04**

Solenoid switch  
Contacteur  
Relé contactor /  
Relé CED  
Relé de Contacto /  
Relé CED

Contattore  
Magneeschakelaar  
Magnetschalter  
Włącznik  
elektromagnetyczny

marş otomatığı  
соленоида  
Chave Magnética

**05**

Cap. terminal  
+ moving contacts  
Contact relé  
+ bornes  
Contactos relé +  
Bornes  
Contactos de relé  
+ Bornes

Contacto coperchio  
+ morsetti  
Magneeschakelaar  
+ sleepingen.  
Magnetschalterab-  
deckung  
+ Kontaktplatte  
+ Anschlüsse

Oslona zacisku  
+ ruchome styki  
Bağlantı kapağı + uçlar  
Cap. Клемма  
+ подвижные  
контакты  
Contactos de relé  
+ Bornes

**06**

Serie Coil  
Bobines série  
Bobinas serie  
Bobines em Série

Bobine serie  
Veldwikkelingsspoel  
(serie)  
In Serie geschaltete  
Magnetspulen

Cewka szeregowej  
Seri bobin  
Последовательная  
обмотка  
Bobines em Série

**08**

Brushes box washers  
Rondelles porte-balais  
Arandelas Porta  
escobillas  
Anilha porta-escovas

Rondella porta  
spazzole  
Koolborstelhouder  
-ringen  
Scheibe, Kohlenträger

Podkładki obudowy  
szczotek  
Kömür taşıyıcı (kapağı)  
Карзина с щетками  
Porta Escovas

**09**

Brushes and springs set  
Jeu de balais et ressorts  
Juego de escobillas y  
muelles  
Jogo de escovas e  
molás

Kit spazzole e molle  
Koolborstelset met  
veren  
Kohlebürstensatz mit  
Federn  
Zestaw szczotek i

sprężynek  
Kömür ve yay takımı  
Набор щеток с  
пружинам  
Jogo de escovas e  
molás

**10**

Bush kit  
Jeu de bagues  
Juego de casquillos  
Jogo de casquilhos

Kit spazzole  
Lagerbussenset  
Ring-Set  
Zestaw tulejek

Burç takımı  
Набор втулок  
Jogo de casquilhos

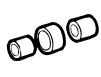
**11**

Pinion fork set  
Ensemble de levier de  
commande  
Conjunto de horquilla  
Conjunto da forquilha

Kit forcella  
Bedieningsvork  
rondsel  
Betätigungseinheit  
Widelki zębnika kpl.

Çatal takımı  
Вилка  
Conjunto de  
Comando

**13**

Commutator end  
shield, assembly  
Palier collecteur  
complet  
Tapa colector completa  
Tampa de coletor  
completa

Supporto collettore  
completo  
Behuizing collector  
compleet  
Komplettes Hinteres  
Lagerschild  
Tylna osłona  
komutatora kpl.

Arka koruma kapak  
takımı  
Задняя крышка в  
сборе  
Mancal Traseiro

**14**

Drive end housing  
Support lanceur  
Soporte piñón  
Suporte do pinhão

Supporto pignone  
Rondsel-lager  
Vorderes Gehäuse  
des Anlassers  
Głowica rozrusznika

Marş dişli desteği  
Головка корпуса  
стартера  
Suporte Dianteiro

**16**

Pinion stop assembly  
Jeu de pièces butée  
lanceur  
Juego de piezas  
retención piñón  
Jogo de peças de  
retenção do pinhão

Corredo sostegno  
pignone  
Rondsel stopinrichting  
Ritzelanschlagset  
Pierścien oporowy  
zębnika kpl.

Pinyon tahdit bilezik  
takımı parçaları  
Передняя защитная  
втулка  
Jogo de peças de  
retenção do pinhão

**20**

Gaskets Set  
Jeu de joints  
Juego de juntas  
Jogo de Juntas

Set guarnizioni  
Pakkingset  
Dichtungssatz  
Zestaw uszczelke

Conta takımı  
Набор прокладок  
Jogo de Juntas

**22**

Intermediate housing  
assembly  
Palier intermédiaire  
complet  
Tapa intermedia  
completa

Tampa intermédia  
completa  
Supporto intermediario  
completo  
Tussenbehuizing  
compleet  
Zwischenlagerhalterung

Obudowa środkowa kpl.  
İç kapak takımı  
Промежуточная  
крышка в сборе  
Tampa intermédia  
completa

**24**

Repair kit  
Jeu de pièces  
réparation  
Juego piezas de  
reparación

Jogo de peças de  
reparação  
Kit riparazione  
Reparatieset  
Reparatursatz

Zestaw naprawczy  
Tamir takımı  
Ремонтный набор  
Jogo de peças de  
reparação

**25**

Spare part kit  
Nécessaire  
de réparation  
Kit de reparación  
Kit de reparação  
Kit ricambi

Noodzakelijk voor  
reparatie  
Ersatzteilkit  
Zestaw części  
zamiennych  
Tamir takımı

Набор запасных  
частей  
Kit de reparação

**26**

Pignon drive shaft  
assembly  
Arbre lanceur  
Eje piñón  
Pinhão e veio

Albero pignone  
Rondselas  
Welle des Ritzels  
Oś zębnika kpl.

Dişli mili  
Вал ведущей  
шестерни в сборе  
Planetária

**50**

Motor spacer  
Entretoise moteur  
Guía de montaje  
Guia de montagem

Compartimento  
motore  
Motor compartiment  
Abstandshalter

Komora silnika  
Motor boşluğu  
Моторный отсек  
Guia de montagem



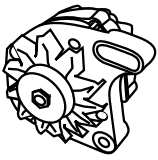

	<b>02</b> <b>SEP</b> : Separate regulator	<b>INC</b> : Built-in regulator
	<b>SEP</b> : Régulateur séparé	<b>INC</b> : Régulateur Incorporé
	<b>SEP</b> : Regulador separado	<b>INC</b> : Regulador Incorporado
	<b>SEP</b> : Regulador separado	<b>INC</b> : Regulador Incorporado
	<b>SEP</b> : Regulatore separato	<b>INC</b> : Regulatore Incorporato
	<b>SEP</b> : Externe regelaar	<b>INC</b> : Ingebouwde regelaar
	<b>SEP</b> : Mit externem Regler	<b>INC</b> : Mit integriertem Regler
	<b>SEP</b> : Oddzielny regulator	<b>INC</b> : wbudowany regulator
	<b>SEP</b> : Dıştan konjektör	<b>INC</b> : İçten konjektör
<b>SEP</b> : Отдельный регулятор	<b>INC</b> : встроенный регулятор	
<b>SEP</b> : Regulador separado	<b>INC</b> : Regulador incorporado	

	<b>03</b> Front housing	Supporto anteriore equipaggiato	Przednia obudowa
	Palier avant équipé	Voorste behuizing	Ön kapak-Parçaları
	Tapa delantera	Ausgestattetes vorderes Lagerschild	Передняя крышка
	Tampa dianteira		Mancal Dianteiro

	<b>04</b> Rotor	Rotore	Rotor
	Rotor	Rotor	Якорь
	Rotor	Rotor	Rotor
	Rotor	Wirnik	

	<b>05</b> Stator	Statore	Stator
	Stator	Stator	Стартер
	Estator	Stator	Estator
	Estator	Stojan	

	<b>06</b> Rear Bracket	Supporto posteriore	Arka kapak
	Palier arrière	Achterste behuizing	Задняя скоба/кронштейн
	Tapa trasera	Hinteres Lagerschild	
	Tampa traseira	Tylna obudowa	Mancal Traseiro

	<b>07</b> Rectifier	Ponte diodi	Diod köprüsü
	Pont de diodes	Diodebrug	Выпрямитель/диод
	Placa de diodos	Diodenbrücke	Ponte Retificadora
	Placa de diodos	Mostek diodowy	

	<b>08</b> Auxiliary diodes	Diodi ausiliari	Yardımcı diod desteği
	Support de diodes auxiliaires	Hulpdiodbrug	Дополнительные диоды
	Diodos auxiliares	Externer Diodenträger	Suporte de Diodo auxiliar
	Suporte de Diodo auxiliar	Diody pomocnicze	

	<b>09</b> Brush holder	Porta spazzole	Kömür tutuculu indüktör
	Porte-balais complet	Borstelhouder	Щеткодержатель
	Porta-escobillas	Kohlenhalter	Regulador
	Porta-escovas	Szczotkotrzymacz	

	<b>09a</b> Brushes	Spazzole	Kömür takımı
	Jeu de balais	Koolborstelset	Набор щеток
	Juego de escobillas	Kohlebürstensatz	Jogo de Escovas
	Jogo de Escovas	Szczotki	

	<b>11</b> Pulley	Puleggia	Kasnak
	Poulie	Poulie	Ременной шкив
	Polea	Riemenscheibe	Polia
	Polia	Koło pasowe	

	<b>11b</b> Free Wheel Pulley	Vrijlooppoele	Муфта свободного хода
	Poulie roue libre	Freilauf-Riemenscheibe	Polia de roda livre
	Polea de rueda libre	Kolo pasowe ze sprzęgłem jednokierunkowym	
	Polia da roda livre	Puleggia a Ruota Libera	
		Volan kasnaği	

	<b>11c</b> Clutch Pulley	Puleggia Frizione	OAD Kasnak
	Poulie débrayable	Krukaspoelie	Разобщающая муфта
	Polea desacopladora	Generator-Entkoppler	Polia OAD
	Polia OAD	Sprzęgłko Kola Pasowego	

	<b>12</b> Fan	Ventilatore	Pervane
	Ventilateur	Ventilator	Вентилятор
	Ventilador	Lüfterscheibe	Ventilador
		Wentylator	

	<b>13</b> Hardware of pulley	Bevestigingsset voor poelie	Крепление ременного шкива
	Jeu de pièces fixation poulie	Befestigungssatz für Riemenscheibe	Peças de fixação da polia
	Piezas sujeción polea	Mocowanie koła pasowego	
	Peças de fixação da polia	Kasnak sabitleme takımı parçaları	
	Corredo fissaggio puleggia		

	<b>14</b> Condenser	Condensatore	Kondansatör
	Condensateur	Condensator	Конденсатор
	Condensador	Kondensator	Condensador
	Condensador	Kondensator	

	<b>15</b> Through Bolt	Perno di fissaggio	Vida ile
	Tige d'assemblage	Schroef	Стяжной болт
	Perno de montaje	Verbindungsschrauben	Perno de montagem
	Perno de montagem	Szplika	

	<b>21</b> Front bearing	Cuscinetto anteriore	Ön rulman
	Roulement avant	Lager voor	Передний подшипник
	Rodamiento delantero	Kugellager Vorne	Rolamento dianteiro
	Rolamento dianteiro	Przednie łożysko	

	<b>22</b> Rear bearing	Cuscinetto posteriore	Arka rulman
	Roulement arrière	Lager achter	Задний подшипник
	Rodamiento trasero	Kugellager Hinten	Rolamento posterior
	Rolamento posterior	Tylne łożysko	

	<b>24</b> Protective cover	Copertura protettiva	Koruma kapağı
	Capot de protection	Beschermkap	Защитная крышка
	Tapa de protección	Schutzkappe	Tampa de Proteção
	Tampa de protecção	Obudowa ochronna	

	<b>25</b> Rear holder	Staffa posteriore	Arka braket
	Patte arrière	Achterste houder	Задний держатель
	Sugeción trasera	Hintere Befestigung	Suporte Traseiro
	Fixação posterior	Tylny wspornik	

	<b>26</b> Plastic capsule	Capsula in plastica	Plastik kapsül
	Capsule plastique	Kunststof kapje	Пластиковая капсула
	Cápsula de plástico	Kunststoffabdeckung	Капсула
	Cápsula de plástico	Plastikowa pokrywa	Cápsula Plástica

	<b>30</b> Repair kit	Reparatieset (inwendige ventilator)	İçten soğutmalı alternatör tamir takımı
	Kit de réparation VI	Reparatursatz	Ремонтный набор
	Kit de reparación VI	Zestaw naprawczy	Kit de Reparação
	Kit de reparação VI		
	Kit riparazione VI		

<p><b>1</b></p> <p>B+</p> <p>Fiche 6.35 x 0.8</p>	<p><b>12</b></p> <p>L/D+</p> <p>Fiche 6.3 x 0.8</p>	<p><b>22</b></p> <p>L/D+ DF</p>	<p><b>34</b></p> <p>L, D</p>	<p><b>50</b></p> <p>S/B+ RC LI</p>	<p><b>60</b></p> <p>COM</p>	<p><b>71</b></p> <p>S L +C IG</p>
<p><b>2</b></p> <p>W</p> <p>Fiche 6.35 x 0.8</p>	<p><b>13</b></p> <p>B+ B+</p> <p>Fiches 6.3 x 0.8</p>	<p><b>23</b></p> <p>COM</p>	<p><b>35</b></p> <p>DFM L</p>	<p><b>51</b></p> <p>S DFM L</p>	<p><b>61</b></p> <p>S M IG L</p>	<p><b>72</b></p> <p>S L IG</p>
<p><b>3</b></p> <p>L</p> <p>Fiche 6.35 x 0.8</p>	<p><b>14</b></p> <p>EXC</p> <p>Fiche 6.3 x 0.8</p>	<p><b>24</b></p> <p>DF L</p>	<p><b>36</b></p> <p>COM</p>	<p><b>52</b></p> <p>S D Fr</p>	<p><b>62</b></p> <p>S DFM</p> <p>S DFM IG L</p>	<p><b>73</b></p> <p>S L W IG</p>
<p><b>4</b></p> <p>DF</p> <p>Fiche 6.35 x 0.8</p>	<p><b>15</b></p> <p>D+ W</p>	<p><b>25</b></p> <p>S, L</p>	<p><b>37</b></p> <p>15 L(61E)</p>	<p><b>53</b></p> <p>S RC LI</p>	<p><b>63</b></p> <p>F (G) E (Y) A (W) N (R)</p>	<p><b>74</b></p> <p>D Fr IG L</p>
<p><b>5</b></p> <p>D+</p> <p>Fiche 6.35 x 0.8</p>	<p><b>16</b></p> <p>L +</p> <p>Fiche 6.3 x 0.8 Fiche 5 x 0.8</p>	<p><b>27</b></p> <p>DF L B+</p>	<p><b>38</b></p> <p>COM DFM</p>	<p><b>54</b></p> <p>S MON COM</p>	<p><b>65</b></p> <p>C IG L</p>	<p><b>75</b></p> <p>D IG L</p>
<p><b>6</b></p> <p>EXC</p> <p>Fiche 6.35 x 0.8</p>	<p><b>17</b></p> <p>COM</p>	<p><b>28</b></p> <p>DF L B+</p>	<p><b>39</b></p> <p>DFM COM</p>	<p><b>55</b></p> <p>L DFM</p>	<p><b>66</b></p> <p>L S IG</p>	<p><b>76</b></p> <p>D+ IG</p>
<p><b>7</b></p> <p>RELAY</p> <p>Fiche 6.35 x 0.8</p>	<p><b>18</b></p> <p>D+ DF</p>	<p><b>30</b></p> <p>L DFM</p>	<p><b>40</b></p> <p>I S A</p>	<p><b>56</b></p> <p>FR SIG A</p>	<p><b>67</b></p> <p>N L IG S</p>	<p><b>77</b></p> <p>C FR IG L</p>
<p><b>8</b></p> <p>+</p> <p>Fiche 6.35 x 0.8</p>	<p><b>19</b></p> <p>DF L</p>	<p><b>31</b></p> <p>L</p>	<p><b>41</b></p> <p>Langette 2.8x0.8 ø1F 75 2.8x0.8</p> <p>B+ D+</p>	<p><b>57</b></p> <p>Fr L</p>	<p><b>68</b></p> <p>S N IG L</p>	<p><b>78</b></p> <p>IG L</p>
<p><b>9</b></p> <p>B-</p> <p>Fiche 6.35 x 0.8</p>	<p><b>20</b></p> <p>L DFM</p>	<p><b>32</b></p> <p>COM</p>	<p><b>42</b></p> <p>B+ D+ W (M6) (M5) (M5)</p>	<p><b>58</b></p> <p>RVC</p> <p>L F</p>	<p><b>69</b></p> <p>S L N IG</p>	<p><b>79</b></p> <p>S FR IG L</p>
<p><b>11</b></p> <p>L</p> <p>Fiches 6.3 x 0.8</p>	<p><b>21</b></p> <p>L</p>	<p><b>33</b></p> <p>COM</p>	<p><b>43</b></p> <p>W D+ B+</p>	<p><b>59</b></p> <p>R - TERMINAL L - TERMINAL (IWL)</p>	<p><b>70</b></p> <p>S D IG L</p>	<p><b>80</b></p> <p>D DF R D+</p>



81 	94 	110 L IG(R) 	120 	130 P L F S 	140 D+ DF 	150 
82 	95 	111 	121 	131 L Fr 	141 E F P 	151 
85 	96 	112 S L 	122 	132 	142 B+ D+ 	152 
86 	97 AMP D+ Connector 	113 R L 	123 	133 	143 	153 
87 	101 Exc 	114 	124 	134 D IG L 	144 	154 
88 	102 DF 	115 	125 	135 	145 	155 
89 	103 DF 	116 	126 	136 W 15 DFM 	146 	156 
90 	104 Exc 	117 	127 	137 	147 S W 	157 
91 B+B+ D+ 	105 D+ DF 	118 	128 	138 	148 	158 
92 D+ 	106 	119 	129 	139 M IG L 	149 	159 



<p><b>160</b></p>	<p><b>171</b></p>	<p><b>200</b></p>	<p><b>224</b></p>	<p><b>270</b></p>
<p><b>161</b></p>	<p><b>172</b></p>	<p><b>201</b></p>	<p><b>230</b></p>	<p><b>271</b></p>
<p><b>162</b></p>	<p><b>180</b></p>	<p><b>210</b></p>	<p><b>231</b></p>	<p><b>280</b></p>
<p><b>163</b></p>	<p><b>181</b></p>	<p><b>217</b></p>	<p><b>240</b></p>	<p><b>290</b></p>
<p><b>164</b></p>	<p><b>182</b></p>	<p><b>218</b></p>	<p><b>247</b></p>	
<p><b>165</b></p>	<p><b>183</b></p>	<p><b>219</b></p>	<p><b>249</b></p>	
<p><b>166</b></p>	<p><b>184</b></p>	<p><b>220</b></p>	<p><b>250</b></p>	
<p><b>167</b></p>	<p><b>190</b></p>	<p><b>221</b></p>	<p><b>253</b></p>	
<p><b>168</b></p>	<p><b>191</b></p>	<p><b>222</b></p>	<p><b>260</b></p>	
<p><b>169</b></p>	<p><b>199</b></p>	<p><b>223</b></p>	<p><b>261</b></p>	

---

**NOTES NOTES NOTAS NOTAS NOTE NOTITIES NOTIZEN NOTATAKI NOT ПРИМЕЧАНИЯ POZNAMKY**

---

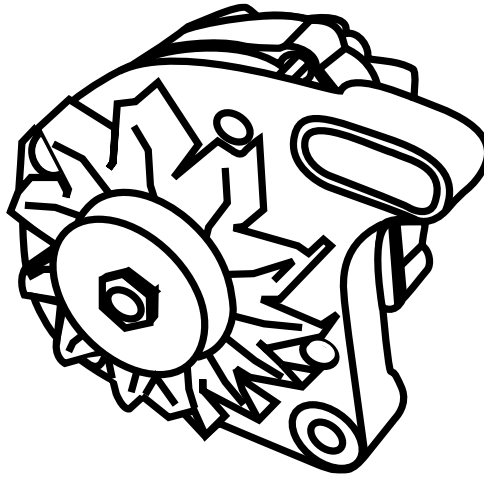







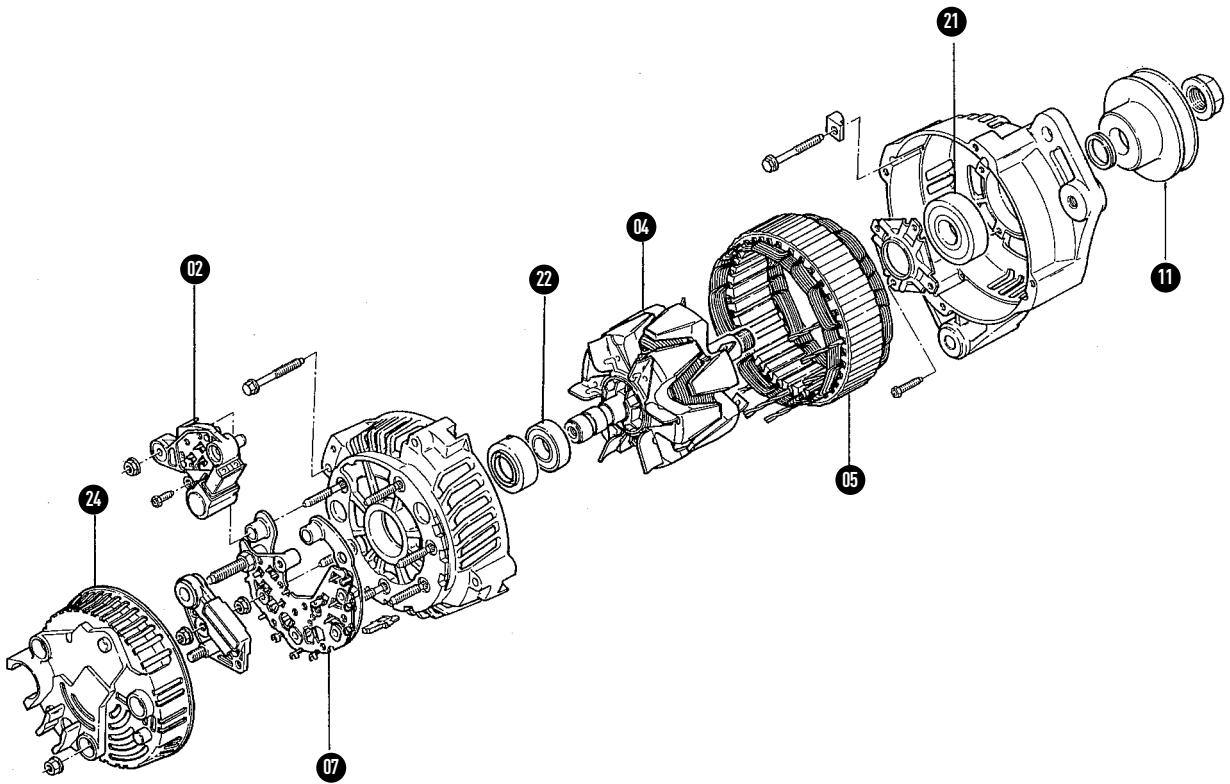

<b>A11VI</b>	19
<b>A13N-A13V-A13VI</b>	26
<b>A14N-A14R-A14S</b> <b>A14V-A14VI</b>	44
<b>SG7-SG8-SG9</b> <b>SG10-SG11S</b> <b>SG12-SG14-SG15</b>	53
<b>TG7-TG8-TG9</b> <b>TG10-TG14</b> <b>TG15-TG16-TG17</b>	62
<b>FG9-FG15-FG17</b> <b>FG18-FG20-FG23</b>	79



## 1 A11VI











											TC	i	Valeo	
A11VI10	1	14	50	900	38	50	CW	D	60		YM6952	INC	593350	
A11VI11	1	14	70	1000	52	67	CW	D	60		YM6952	INC	593350	
A11VI15	1	14	50	1300	38	50	CW	D	20		YM6952	INC	593350	
A11VI16	1	14	50	800	43	50	CW	D	20		YM6952	INC	593350	
A11VI17	1	14	70	1000	52	67	CW	D	20		YM6952	INC	593350	
A11VI18	1	14	70	1000	52	68	CW	D	20		YM6952	INC	593350	
A11VI21	1	14	70	1200	58	70	CW	D	7688	3	YM194	INC	593131	593150
A11VI22	1	14	60	1200	50	60	CW	D	7688	122 / W	YM194	INC	593131	
A11VI23	1	14	70	1000	52	67	CW	D	20		YM6952	INC	593350	
A11VI24	1	14	50	900	38	50	CW	D	20		YM6952	INC	593350	
A11VI25	1	14	70	1000	52	67	CW	D	20		YM6952	INC	593350	
A11VI26	1	14	75	1000	62	72	CW	D	35	199 / W				593150
A11VI28	1	14	75	1000	63	72	CW	D	19	199 / W				593150
A11VI29	1	14	75	1000	63	72	CW	G	25	16 / W				593150
A11VI30	1	14	75	1000	62	72	CW	G	25	199 / W				593150
A11VI31	1	14	75	1000	63	72	CW	D	19	199 / W				593150
A11VI32	1	14	70	1000	61	67	CW	G	60		YM6952	INC	593350	593150
A11VI33	1	14	50	850	43	50	CW	D	20		YM6952	INC	593350	
A11VI35	1	14	70	1200	58	70	CW	D	90	122 / W	YM194	INC	593131	593150
A11VI36	1	14	70	1200	58	70	CW	D	90	122 / W	YM194	INC	593131	593150
A11VI37	1	14	50	800	43	50	CW	D	60		YM194	INC	593131	
A11VI40	1	14	70	1000	61	67	CW	D	20		YM6952	INC	593350	593150
A11VI42	1	14	50	900	43	50	CW	D	60		YM6952	INC	593350	
A11VI43	1	14	70	1000	61	67	CW	D	60		YM6952	INC	593350	593150
A11VI44	1	14	70	1000	61	67	CW	D	60		YM6952	INC	593350	593150
A11VI45	1	14	70	1000	61	67	CW	G	55		YM6952	INC	593350	593150
A11VI46	1	14	65	1200	57	68	CW	D	27		YM6952	INC	593350	593150
A11VI47	1	14	50	800	43	50	CW	D	20					
A11VI48	1	14	70	1000	60	67	CW	D	20		YM6952	INC	593350	593150
A11VI49	1	14	70	1000	61	67	CW	D	20					593150
A11VI51	1	14	70	1000	61	67	CW	D	20					593150
A11VI52	1	14	70	1200	61	67	CW	D	20		YM6952	INC	593350	593150
A11VI53	1	14	50	900	43	50	CW	D	20					
A11VI54	1	14	75	1000	63	72	CW	G	25	16 / W	YM1601T	INC	593141	593150
A11VI55	1	14	70	1000	61	67	CW	D	60		YM6952	INC	593350	593150
A11VI56	1	14	70	1000	61	67	CW	D	60					593150
A11VI57	1	14	70	1000	61	67	CW	D	20		YM6952	INC	593350	593150
A11VI58	1	14	50	1000	43	50	CW	D	20		YM6952	INC	593350	
A11VI59	1	14	75	1000	62	72	CW	GD		199 / W				593150
A11VI61	1	14	75	1000	63	72	CW	D	19	199 / W				593150
A11VI62	1	14	70	1200	61	70	CW	D	90	122 / W	YM194	INC	593131	593150
A11VI64	1	14	70	1200	60	70	CW	D	90	122 / W	YM194	INC	593131	593150
A11VI66	1	14	70	1200	60	70	CW	D	7688	122 / W	YM194	INC	593131	593150
A11VI67	1	14	75	1000	63	72	CW	G	65	200	YM1615P1	INC	593303	593150
A11VI72	1	14	70	1000	61	67	CW	D	20	2 / W	YM6952	INC	593350	593150
A11VI76	1	14	75	1100	64	72	CW	GD		12 / W	YM1601T	INC	593141	593150
A11VI77	1	14	75	1100	64	72	CW	GD		12 / W	YM1601T	INC	593141	593150
A11VI79	1	14	75	1000	63	72	CW	GD		200 / W	YM1600	INC	593290	593150
A11VI81	1	14	75	1000	62	72	CW	GD		201 / W	YM1600	INC	593290	593150
A11VI82	1	14	70	1200	60	70	CW	D	90	30	RC9101	INC	593362	593150
A11VI85	1	14	75	1000	63	72	CW	D	19	200 / W	YM1413	INC	593310	593150
A11VI87	1	14	75	1000	63	72	CW	G	30	21 / W	YM1662P	INC	593411	593150
A11VI88	1	14	75	1000	63	72	CW	GD		22	YM1662P	INC	593411	593356
A11VI89	1	14	70	1000	61	67	CW	G	60	/ W	YM6952	INC	593350	593150
A11VI91	1	14	70	1000	61	67	CW	G	40		YM6952	INC	593350	593150
A11VI92	1	14	75	1000	63	72	CW	GD		200 / W	YM1413	INC	593310	593150
A11VI93	1	14	75	1000	63	72	CW	D	19	200 / W	YM1413	INC	593310	593150
A11VI94	1	14	75	1000	63	72	CW	GD		21	YM1662P	INC	593411	593150
A11VI95	1	14	70	1200	60	70	CW	D	90	30	RC9101	INC	593362	593150
A11VI96	1	14	75	1000	63	72	CW	G	6682	201	YM1600	INC	593290	593150
A11VI97	1	14	75	1000	62	72	CW	GD		201 / W	YM1600	INC	593290	593356
A11VI98	1	14	75	1000	63	72	CW	G	6582	21	YM1662P	INC	593411	593150
A11VI99	1	14	70	1000	61	67	CW	G	40	18	YM6956	INC	593375	593150
A11VI101	1	14	70	1000	61	67	CW	D	60	22	YM6956	INC	593375	593150









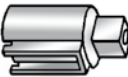

TC								
A11VI10		593163	593253	592851	593563 ▲			592854
A11VI11	593279	593163	593253	592851	593563 ▲	593564 ▲		592854
A11VI15		592848		592853	593563 ▲			592854
A11VI16		592848		592853	593563 ▲	593564 ▲		592854
A11VI17	593279	592848		592853	593563 ▲	593564 ▲		592854
A11VI18	593279	592848	593741	592853	593563 ▲	593564 ▲		592854
A11VI21	593279	592915		592933	593563 ▲	593564 ▲	593241 ▲	592854
A11VI22	593279	592915	592920	592933	593563 ▲	593564 ▲	593241 ▲	592854
A11VI23	593279	593163	593743	592851	593563 ▲	593564 ▲		592854
A11VI24		593163		592851	593563 ▲			592854
A11VI25	593279	593163		592851	593563 ▲			592854
A11VI26	593279	592847		592852	593563 ▲	593564 ▲	592944 ▲	592854
A11VI28	593279	592847		592852	593563 ▲	593564 ▲	592944 ▲	592854
A11VI29	593279	592847	593741	592852	593563 ▲	593564 ▲	592945 ▲	592854
A11VI30	593279	592847	593740	592852	593563 ▲	593564 ▲	592944 ▲	592854
A11VI31	593279	592847	592924	592852	593563 ▲	593564 ▲	592944 ▲	592854
A11VI32	593279	593163	593742	592851	593563 ▲	593564 ▲		592854
A11VI33		593163	593743	592851	593563 ▲	593564 ▲		592854
A11VI35	593279	592915		592933	593563 ▲	593564 ▲	593241 ▲	592854
A11VI36	593279	592915	592920	592933	593563 ▲	593564 ▲	593241 ▲	592854
A11VI37		593163	96880	592851	593563 ▲	593564 ▲		592854
A11VI40	593279	593163		592851	593563 ▲	593564 ▲		592854
A11VI42		593163		592851	593563 ▲	593564 ▲		592854
A11VI43	593279	593163	96880	592851	593563 ▲	593564 ▲		592854
A11VI44	593279	593163	593742	592851	593563 ▲	593564 ▲		592854
A11VI45	593279	593163	593742	592851	593563 ▲	593564 ▲		592854
A11VI46	593279	593166	593704		593563 ▲	593564 ▲	593239 ▲	592854
A11VI47		592848		592853	593563 ▲	593564 ▲		592854
A11VI48	593279	592848	593741	592853	593563 ▲	593564 ▲		592854
A11VI49	593279	593163	593743	592851	593563 ▲	593564 ▲		592854
A11VI51	593279	593163		592851	593563 ▲	593564 ▲		592854
A11VI52	593279	593163	593742	592851	593563 ▲	593564 ▲		592854
A11VI53		593163	593743	592851	593563 ▲	593564 ▲		592854
A11VI54	593279	593175	593741		593563 ▲	593564 ▲	593242 ▲	592854
A11VI55	593279	593163	593749	592851	593563 ▲	593564 ▲		592854
A11VI56	593279	593163	593742	592851	593563 ▲	593564 ▲		592854
A11VI57	593279	593163	593743	592851	593563 ▲	593564 ▲		592854
A11VI58		593163	593743	592851	593563 ▲	593564 ▲		592854
A11VI59	593279	592847		592852	593563 ▲	593564 ▲	592944 ▲	592854
A11VI61	593279	592847	593746	592852	593563 ▲	593564 ▲	592944 ▲	592854
A11VI62	593279	592915	593615	592933	593563 ▲	593564 ▲	593241 ▲	592854
A11VI64	593279		592920	592933	593563 ▲	593564 ▲	593241 ▲	592854
A11VI66	593279	592915	592920	592933	593563 ▲	593564 ▲	593241 ▲	592854
A11VI67	593279	593304	593753		593563 ▲	593564 ▲	593291 ▲	592854
A11VI72	593279	593557	593725	592851	593563 ▲	593564 ▲		592854
A11VI76	593279	593175			593563 ▲	593564 ▲	593242 ▲	592854
A11VI77	593279	593175			593563 ▲	593564 ▲	593242 ▲	592854
A11VI79	593279	593175			593563 ▲	593564 ▲	593291 ▲	592854
A11VI81	593279	593306	593701		593563 ▲	593564 ▲	593291 ▲	592854
A11VI82	593279	593364					593367 ▲	592854
A11VI85	593279	593304	593746		593563 ▲	593564 ▲	593291 ▲	592854
A11VI87	593279	593204	593751		593563 ▲	593564 ▲	593317 ▲	592854
A11VI88	593279	593204			593563 ▲	593564 ▲	593374 ▲	592854
A11VI89	593279	593163	592929	592851	593563 ▲	593564 ▲		592854
A11VI91	593279	592848	593754	592853	593563 ▲	593564 ▲		592854
A11VI92	593279	593175			593563 ▲	593564 ▲	593315 ▲	592854
A11VI93	593279	593304	593746		593563 ▲	593564 ▲	593315 ▲	592854
A11VI94	593279	593204	593518		593563 ▲	593564 ▲		592854
A11VI95	593279	593364	592920		593563 ▲	593564 ▲	593367 ▲	592854
A11VI96	593279	593304	593753		593563 ▲	593564 ▲	593315 ▲	592854
A11VI97	593279	593175			593563 ▲	593564 ▲	593315 ▲	592854
A11VI98	593279	593204	593753		593563 ▲	593564 ▲		592854
A11VI99	593279	592848	593754	593377	593563 ▲	593564 ▲	593376 ▲	592854
A11VI101	593279	592848	593749	593377	593563 ▲	593564 ▲	593376 ▲	592854

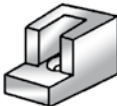

A11VI102	1	14	70	1000	61	67	CW	G	60	22		YM6956	INC	593375	593150	
A11VI104	1	14	75	1000	63	72	CW	GD		201 / W		YM1600	INC	593290	593150	
A11VI105	1	14	75	1000	63	72	CW	D	19	201 / W		YM1600	INC	593290	593150	
A11VI106	1	14	70	1000	61	67	CW	G	40	22 / W		YM6670VF	INC	593419	593150	
A11VI108	1	14	70	1000	60	66	CW	G	60	22		YM6670VF	INC	593419	593150	
A11VI110	1	14	75	1000	63	72	CW	G	6682	21		YM1662P	INC	593411	593150	
A11VI111	1	14	75	1000	63	72	CW	G	6682	21		YM1662P	INC	593411	593150	

TC	 05	 07	 11	 33	 21	 22	 24	 30
A11VI102	593279	592848	592929	593377	593563 ▲	593564 ▲	593376 ▲	592854
A11VI104	593279	593175			593563 ▲	593564 ▲	593315 ▲	592854
A11VI105	593279	593304	593746		593563 ▲	593564 ▲	593315 ▲	592854
A11VI106	593279	593420	593754	593421	593563 ▲	593564 ▲	593376 ▲	592854
A11VI108	593279	593420	592929	593421	593563 ▲	593564 ▲	593376 ▲	592854
A11VI110	593279	593204	593768		593563 ▲	593564 ▲	593374 ▲	592854
A11VI111	593279	593204	593753		593563 ▲	593564 ▲	593374 ▲	592854



	<p>1 Assembling Protector (For Brushes Protection) 1 protecteur de montage (protection des balais) 1 protector de montaje (protección de la escobillas) 1 protector de montagem (para protecção das escovas)</p>	<p>1 protezione montaggio (protezione spazzole) 1 Montage beschermmer (voor bescherming van koelborstels) 1 Montageschutz (für die Kohlen) 1 osłona kpl. (do ochrony szczotek)</p>	<p>1 montaj parçası (kömür koruma için) 1 сборочный протектор (для защиты щеток) 1 protector de montagem (para protecção das escovas)</p>
	<p>1 Rear Bearing Capsule 1 capsule de roulement arrière 1 cápsula de rodamiento trasero 1 cápsula de rolamento traseiro</p>	<p>1 capsula cuscinetti posteriore 1 kapje achterste lager 1 Lagerkapselung, hinten 1 kapsula tylnego łożyska</p>	<p>1 arka rulman kapsülü 1 капсула заднего подшипника 1 cápsula de rolamento traseiro</p>
	<p>4 Holding Nuts Of The Rectifier Bridge 4 écrous de maintien du pont redresseur 4 tuercas de fijación del puente de diodos 4 porcas de fixação da ponte de diodos</p>	<p>4 dadi di tenuta 4 Bevestigingsmoeren van diodebrug 4 Gleichrichter- Befestigungsschrauben 4 nakrętki mocujące mostek diodowy</p>	<p>4 diod köprüsü tutucu vidası 4 гайки диодного моста 4 porcas de fixação da ponte de diodos</p>
	<p>6 Grommets 6 passe-fils 6 pasa cables 6 abraçadeiras</p>	<p>6 gommini 6 Doorvoertules 6 Drahtdurchführungen 6 spinek</p>	<p>6 Kablo kovarı 6 резиновых втулок 6 abraçadeiras</p>
	<p>Centring screw Vis de centrage Tornillo de centrado Parafuso centrado</p>	<p>Vite di centraggio Centreerschroef Zentrierschraube Šruba centrująca</p>	<p>Merkezleme vidası Центрирующий болт Parafuso centrado</p>
	<p>4 Stator Clamping Flanges Of The Front Cap 4 brides de fixation stator sur capot avant 4 bridas de fijación stator sobre el capot delantero 4 falanges de fixação do estator na tampa dianteira</p>	<p>4 fori di fissaggio statore sul supporto anteriore 4 stator klemflenzen op voorste kap 4 Befestigungsflansch Stator/Vordere Abdeckung 4 nasadki mocujące stojan do przedniej obudowy</p>	<p>4 stator sabitleme ayağı 4 зажима статора к передней крышке 4 falanges de fixação do estator na tampa dianteira</p>
	<p>1 Connecting Screw (Brass) 1 vis de liaison (laiton) 1 tornillo de unión (latón) 1 parafuso de união (latão)</p>	<p>1 vite di fissaggio (ottone) 1 aansluitcroef (messing) 1 Verbindungsschraube (Messing) 1 złączeniowy wkręt (miedziany)</p>	<p>1 bağlama vidası (pirinç) 1 контактный болт (медь) 1 parafuso de união (latão)</p>
	<p>1 Plastic Centering Strip Rotor/Stator 1 bande plastique de centrage rotor/stator 1 banda plástica de centrado 1 banda de plástico de centragem</p>	<p>1 banda plastica di centraggio rotore/statore 1 kunststof centreerstrip voor rotor/stator Zentrierband Rotor/Stator 1 plastikowa taśma centrująca wirnik/stojan</p>	<p>1 plastik rotor/stator merkezleme şeridi 1 пластиковый якорь/статор с центрирующимися (встречными) лентами 1 banda de plástico de centragem</p>
	<p>1 340 Rhodorsyl Silicon Paste (Termal Conductivity) (Before Refitting, Coat The Baseplate Of The Rectifier Bridge) 1 tube de pâte silicone (conducteur thermique) 340 Rhodorsyl (Enduire la semelle du pont redresseur avant remontage) 1 tubo de silicona (conductor térmico) 340 Rhodorsyl (Dar la pasta a la placa de diodos antes del montaje) 1 tubo de silicone (conductor térmico) 340 Rhodorsyl (Aplicar na placa de diodos antes de montar)</p>	<p>1 tubetto di silicone 340 Rhodorsyl (conduttore termico) (Indurre la base della piastra diodi, prima di rimontarla) 1 Tube Rhodorsyl siliconen pasta (thermische geleiding) (Voor hermontage, de grondplaat van de diodebrug insmeren) 1 Silikonpaste. Den Sockel der Diodenplatte vor der Montage bestreichen 1 tubka silikonu przewodzącego ciepło (340 rhodorosylu) (przed montażem posmarować podstawę mostka diodowego)</p>	<p>1 tüp 340 Rhodorsyl silikon (ısı iletken) (tekrar takmadan önce diod köprüsü tabanının kaplamasını yapın) 1 Силиконовая паста Rhodorsyl (теплопроводность) (Перед переустановкой, покройте опорный диск диодного моста) 1 tubo de silicone (conductor térmico) 340 Rhodorsyl. Aplicar na placa de diodos antes de montar</p>
	<p>Plastic capsule Capsule plastique cápsula de plástico</p>	<p>Cápsula de plástico Capsula in plastica Kunststof kapje</p>	<p>Kunststoffabdeckung Plastikowa kapsula Plastik kapsül</p>
	<p>Wire shell Cosse Terminal stator</p>	<p>Terminal Guscio in ferro Kabelgoot</p>	<p>Kabelschuh Izolacja Kablo Korumucu</p>
	<p>Wire shell VI cosse VI Terminal stator</p>	<p>Terminal VI Guscio in ferro Kabelgoot</p>	<p>Kabelschuh Gr.6 Izolacja VI Kablo Korumucu</p>

---

**NOTES NOTES NOTAS NOTAS NOTE NOTITIES NOTIZEN NOTATAKI NOT ПРИМЕЧАНИЯ POZNAMKY**

---

# 1.2 A13N - A13V - A13VI

## 2 A13N

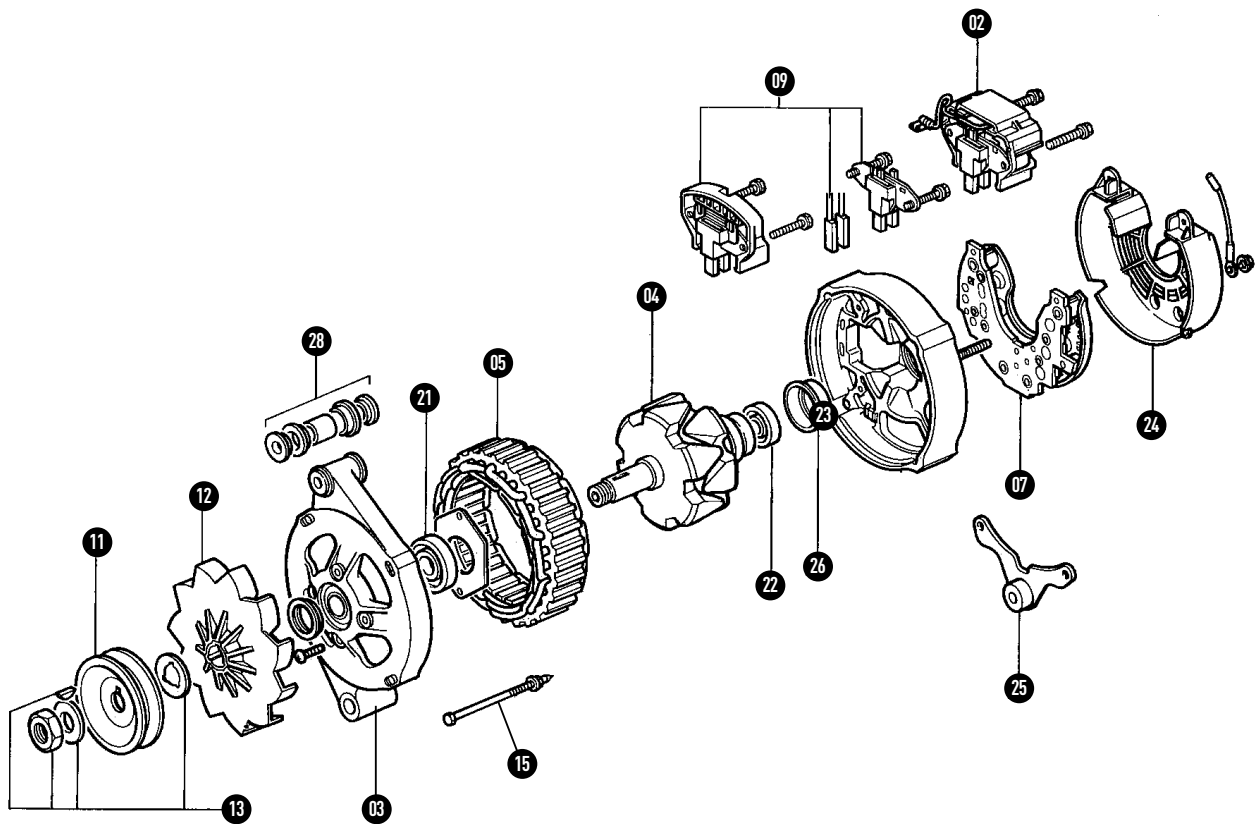

## 3 A13V

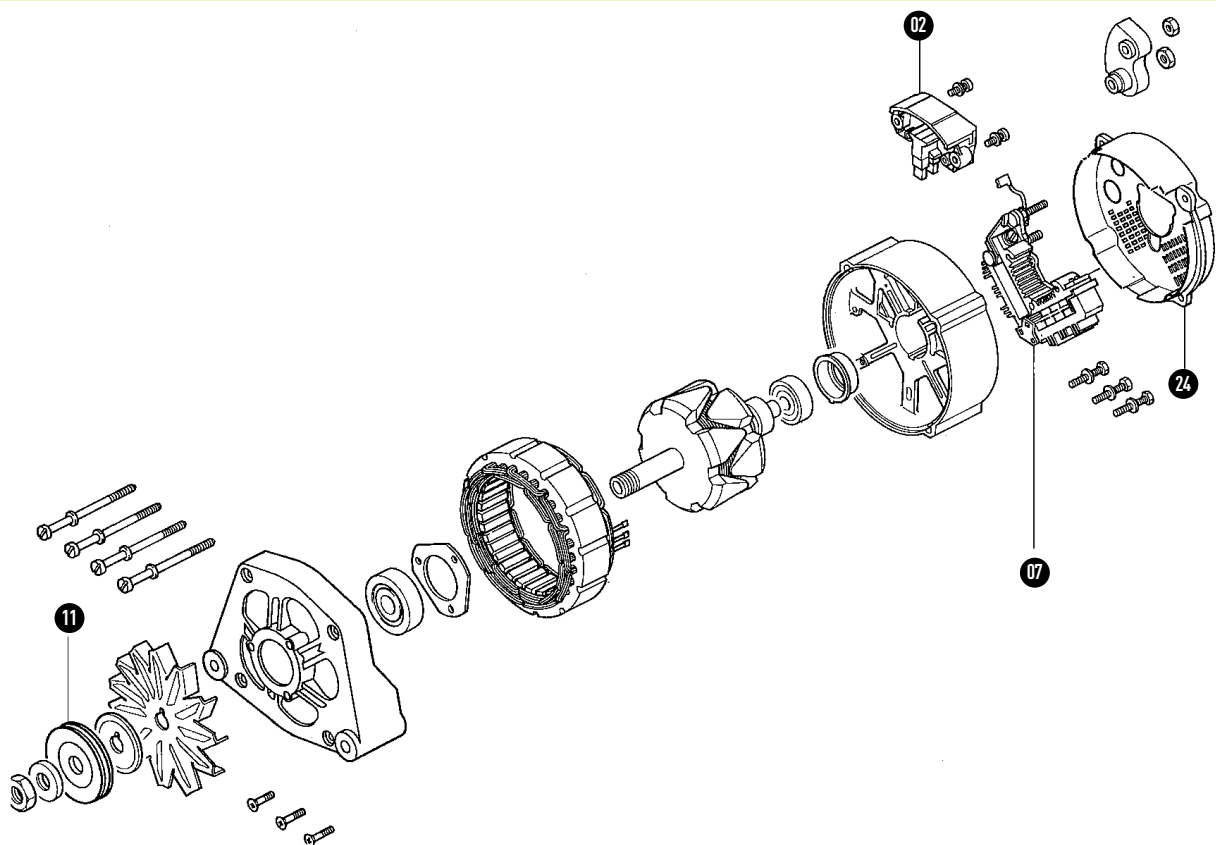

# A13N - A13V - A13VI 1.2

## 4 A13VI

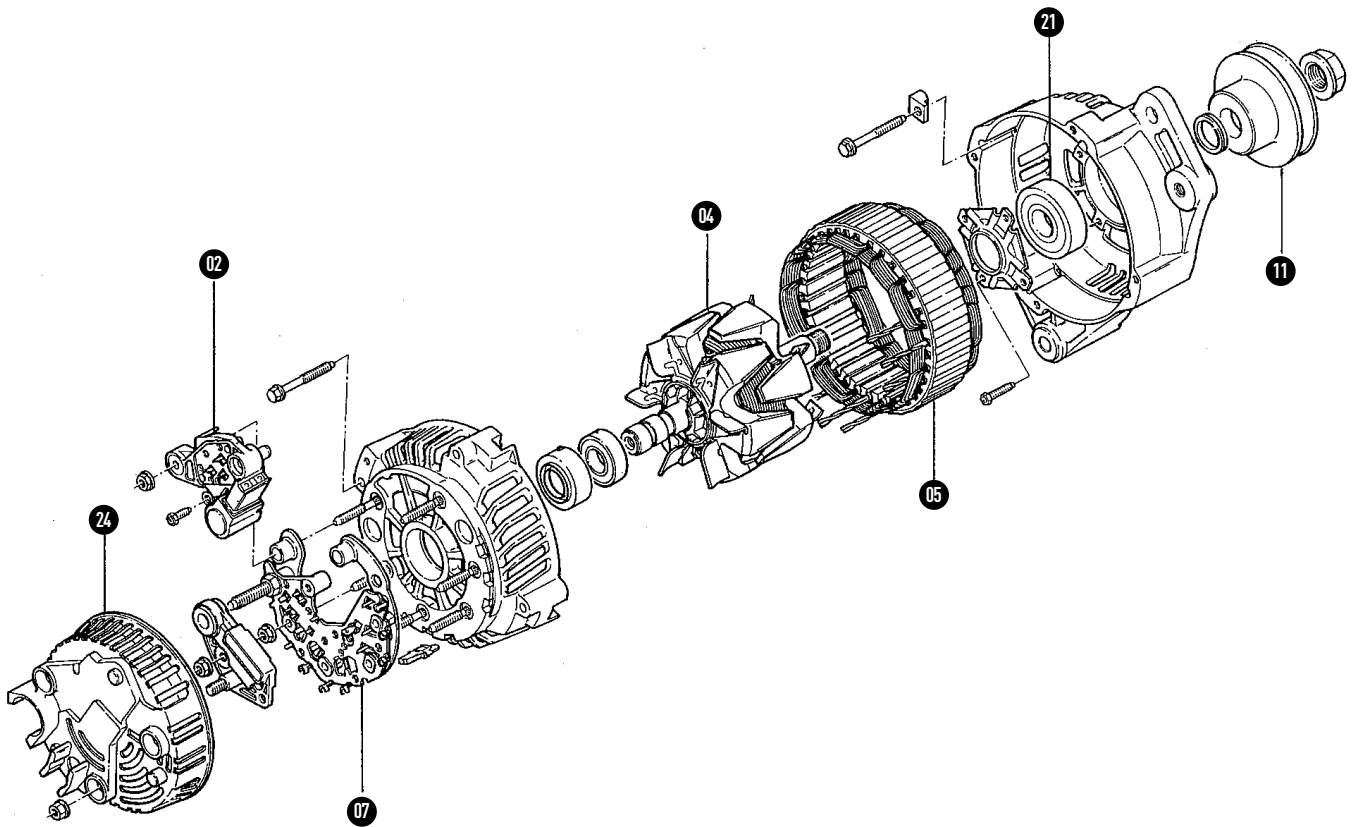



TC	09	09a	11	11c	12	13	33	15	21	22	24	25	26	30
A13N4T			101054			300767								
A13N6			593253											
A13N7														
A13N10			593253		590553									
A13N11														
A13N12			593253		590553									
A13N13			593253		590553									
A13N14														
A13N15														
A13N17														
A13N18														
A13N19														
A13N20			593253		590553									
A13N25+					92477									
A13N27					590553									
A13N29					590553									
A13N30														
A13N31														
A13N33M	92967													
A13N34														
A13N35M	92967				590553									
A13N36M	92967													
A13N38			593253		590553									
A13N42			593253		590553									
A13N43														
A13N46					590553									
A13N49														
A13N50														
A13N51							517022							
A13N52							517022							
A13N53														
A13N55M	92967													
A13N56M	92967													
A13N57M	92967				590553									
A13N58M	92967													
A13N59M	92967													
A13N60T														
A13N61T														
A13N62														
A13N64														
A13N65			96882		590553									
A13N66M	92967				590553									
A13N69					590553									
A13N76					590553									
A13N80														
A13N81														
A13N83			593253		590553									
A13N84			96879											
A13N85														
A13N86														
A13N87			96880											
A13N88														
A13N89														
A13N90														
A13N91														
A13N92														
A13N93					590553									
A13N94+						300767								
A13N95					590553									
A13N97														
A13N103			593253		590553									
A13N104			593253		590553									
A13N106														
A13N107														

















	TC	i	Valeo	03	04	05	07											
A13N108+	2	14	70	1150	57	70		CW	D	42	16 / W	YV2652	INC	590704			592830	592880
A13N109	2	14	50	1000	43	49		CCW	G	60	12	YV1925	INC	182120		92968	100930	
A13N110	2	14	60	1150	53	61		CW	G	20	16	YV1652	INC	590558		92985		180593
A13N112	2	14	60	1200	53	61		CW	GD		16 / W	YV1652	INC	590558				
A13N113	2	14	60	1200	53	61		CW	G	60	16	YV1652	INC	590558				
A13N114	2	14	60	1200	53	61		CW	G	60	16	YV1652	INC	590558		92985		
A13N116	2	14	60	1200	53	61		CW	GD		16	YV1652	INC	590558				
A13N117	2	14	60	1200	53	61		CW	D	42	16	YV1652	INC	590558				
A13N118	2	14	50	1000	42	50		CW	G	20	12	YV1925	INC	182120			100930	105754
A13N119	2	14	50	1050	43	50		CW	D	20	7 / W	YV1652	INC	590558			100930	593193
A13N120	2	14	60	1200	53	61		CW	GD		16	YV1652	INC	590558		92968		
A13N121	2	14	60	1200	53	61		CW	G	20	16	YV1652	INC	590558				
A13N123	2	14	50	1000	43	49		CW	D	42	12	YV1925	INC	182120		300846	100930	
A13N124	2	14	60	1200	53	61		CW	GD		16	YV1652	INC	590558				
A13N125+	2	14	70	1200	57	70		CW	G	60	16	YV2652	INC	590704			592830	105135
A13N126	2	14	50	1000	43	50		CW	GD		16	YV1652	INC	590558		92968	100930	105135
A13N127	2	14	50	1200	43	50		CW	D	60	16	YV1652	INC	590558		92968	100930	
A13N128+	2	14	50	1000	43	50		CW	D	60	16	YV1652	INC	590558		92968	100930	
A13N129	2	14	50	1000	43	49		CW	D	60	12	YV1925	INC	182120		300846	100930	105754
A13N130+	2	14	70	1200	60	69		CW	D	60	12	YV2925	INC	590538			592830	
A13N133+	2	14	70	1200	57	70		CW	GD		12	YV2925	INC	590538			592830	593180
A13N136	2	14	60	1200	53	61		CW	GD		16	YV1652	INC	590558				
A13N137	2	14	50	1000	43	50		CW	D	60	1	YV1652	INC	590558		92968	100930	180593
A13N138+	2	14	70	1200	57	70		CW	GD		12	YV2925	INC	590538			592830	593180
A13N139	2	14	50	1000	43	49		CW	GD		1	YV1652	INC	590558		92968	100930	180593
A13N140T	2	28	40	1500	30	40	⊕	CW	D	20	/ W						101339	102556
A13N143M	2	28	30	1100	23	28	⊕	CW	G	20	/ W							593199
A13N144T	2	14	50	1200	43	50		CW	G	20		YV1925	INC	182120			100930	105754
A13N146T	2	14	50	1000	45	54		CW	D	20	5				590639	100930	105135	
A13N147M	2	14	50	1000	39	46	⊕	CW	G	20	/ W							593199
A13N148M	2	14	50	1000	39	46	⊕	CW	G	20	/ W							593199
A13N149M	2	14	50	1000	39	46	⊕	CW	G	20	/ W							593199
A13N150	2	14	60	1200	53	61		CW	G	60	1	YV1652	INC	590558		92985		180593
A13N151+	2	14	70	1200	60	69		CW	D	20	5	YV2925	INC	590538			592830	592749
A13N152M	2	28	30	1000	23	28	⊕	CW	G	20	/ W							593199
A13N156+	2	14	70	1200	61	71		CW	G	20	1	YV1652	INC	590558			592830	180593
A13N157	2	14	60	1200	53	61		CW	D	20	16	YV1652	INC	590558		590639		180593
A13N158+	2	14	70	1200	60	71		CW	D	20	1	YV1652	INC	590558		590625	592830	180593
A13N159+	2	14	70	1250	61	71		CW	GD		1	YV1652	INC	590558		590625	592830	
A13N160	2	14	60	1200	53	61		CW	D	60	1	YV1652	INC	590558		92968		180593
A13N161+	2	14	70	1200	57	70		CW	GD		1	YV1652	INC	590558		590625	592830	180593
A13N162+	2	14	70	1200	61	71		CW	GD		1	YV1652	INC	590558		590625	592830	180593
A13N163	2	14	60	1100	53	61		CW	GD		1 / W	YV1652	INC	590558				
A13N164+	2	14	70	1200	61	71		CW	GD		1 / W	YV1652	INC	590558		590625	592830	592880
A13N165	2	14	60	1150	51	60		DS			/ W	YV1903	INC	182007				593199
A13N166M	2	28	30	1625	25	31		DS	GD	60	/ W							592882
A13N167	2	14	50	1000	42	49		CW	D	20	5	YV1925	INC	182120		590639	100930	592840
A13N169	2	14	60	1200	53	61		CW	GD		5	YV1925	INC	182120		92968		
A13N171+	2	14	70	1200	61	71		CW	GD		1	YV1652	INC	590558		590625	592830	592881
A13N172+	2	14	70	1200	61	71		CW	GD		1	YV1652	INC	590558			592830	
A13N173+	2	14	70	1200	61	71		CW	GD		1	YV1652	INC	590558			592830	
A13N174	2	28	35	1000	26	32		DS	GD		/ W							593196
A13N175	2	14	50	1000	43	51		CW	D	60	5	YV1925	INC	182120		300846	100930	592877
A13N176+	2	14	70	1200	60	70		CW	D	60	5	YV1925	INC	182120				
A13N177+	2	14	70	1200	60	69		CW	D	20	5	YV1925	INC	182120		590625	592830	592749
A13N178+	2	14	70	1200	61	71		CW	GD		5	YV1925	INC	182120			592830	593180
A13N179+	2	14	70	1200	61	71		CW	GD		5	YV1925	INC	182120			592830	593180
A13N180+	2	14	70	1200	60	71		CW	G	60	16	YV1652	INC	590558			592830	
A13N181	2	14	50	1000	43	50		CW	D	20	5	YV1925	INC	182120		590639	100930	592749
A13N182	2	14	50	1200	43	50		CW	D	20	5	YV1925	INC	182120		590639	100930	592749
A13N183+	2	14	70	1200	60	69		CW	D	20	5	YV1925	INC	182120		590625		592749
A13N184+	2	14	70	1200	60	70		CW	D	20		YV1926T	INC	590688		590625	592830	592878
A13N185+	2	14	70	1200	61	71		CW	D	42	1 / W	YV1652	INC	590558			592830	592880
A13N186M	2	14	50	1000	39	46	⊕	CW	G	20	/ W							593199

TC	09	09a	11	11c	12	13	33	15	21	22	24	25	26	30
A13N108+			96882							590568 ▲	590564 ▲		590627 ▲	
A13N109		300821			92477	300767				590568 ▲	590564 ▲	593227 ●	590627 ▲	
A13N110			593253							590568 ▲	590564 ▲		590627 ▲	
A13N112														
A13N113														
A13N114			593253								590564 ▲		590627 ▲	
A13N116														
A13N117														
A13N118			593253							590568 ▲	590564 ▲		590627 ▲	
A13N119			101932							590568 ▲	590564 ▲		590627 ▲	
A13N120			592757							590619 ▲	590564 ▲		590627 ▲	
A13N121														
A13N123		300821								590568 ▲	590564 ▲		590627 ▲	
A13N124														
A13N125+										590568 ▲	590564 ▲		590627 ▲	
A13N126			592757							590568 ▲	590564 ▲		590627 ▲	
A13N127			592757							590613 ▲	590564 ▲		590627 ▲	
A13N128+											590564 ▲		590627 ▲	
A13N129										590568 ▲			590627 ▲	
A13N130+													590627 ▲	
A13N133+										590619 ▲	590564 ▲		590627 ▲	
A13N136														
A13N137					590553					590568 ▲	590564 ▲		590627 ▲	
A13N138+										590619 ▲	590564 ▲		590627 ▲	
A13N139											590564 ▲		590627 ▲	
A13N140T											590564 ▲			
A13N143M	92967									590613 ▲	590564 ▲		590629 ▲	
A13N144T			593253							590619 ▲	590564 ▲		590627 ▲	
A13N146T											590564 ▲	593227 ●	590627 ▲	
A13N147M	92967				590553					590613 ▲	590564 ▲		590629 ▲	
A13N148M	92967				590553					590613 ▲	590564 ▲		590629 ▲	
A13N149M	92967									590613 ▲	590564 ▲		590629 ▲	
A13N150			593253							590568 ▲	590564 ▲		590627 ▲	
A13N151+											590564 ▲		590627 ▲	
A13N152M	92967									590613 ▲	590564 ▲		590629 ▲	
A13N156+											590564 ▲		590627 ▲	
A13N157										590568 ▲	590564 ▲		590627 ▲	
A13N158+											590564 ▲		590627 ▲	
A13N159+			592757							590619 ▲	590564 ▲	593230 ●	590627 ▲	
A13N160										590568 ▲	590564 ▲		590627 ▲	
A13N161+											590564 ▲		590627 ▲	
A13N162+			105760							590619 ▲	590564 ▲	593230 ●		
A13N163														
A13N164+			105760							590568 ▲	590564 ▲	593230 ●	590627 ▲	
A13N165								518611		590619 ▲			590627 ▲	
A13N166M	92967								592780 ▲	590613 ▲	590607 ▲		590629 ▲	
A13N167			592760								590564 ▲		590627 ▲	
A13N169										590619 ▲	590564 ▲		590627 ▲	
A13N171+			96882							590568 ▲	590564 ▲	593230 ●	590627 ▲	
A13N172+										590568 ▲	590564 ▲	593230 ●	590627 ▲	
A13N173+			593253							590568 ▲	590564 ▲	593230 ●	590627 ▲	
A13N174										590613 ▲	590564 ▲			
A13N175										590568 ▲			590627 ▲	
A13N176+										590568 ▲			590627 ▲	
A13N177+										590568 ▲	590564 ▲		590627 ▲	
A13N178+										590568 ▲	590564 ▲		590627 ▲	
A13N179+										590619 ▲	590564 ▲		590627 ▲	
A13N180+											590564 ▲	593230 ●	590627 ▲	
A13N181													590627 ▲	
A13N182			592760										590627 ▲	
A13N183+										590568 ▲			590627 ▲	
A13N184+			181485										590627 ▲	
A13N185+			96882							590568 ▲	590564 ▲		590627 ▲	
A13N186M	92967									590613 ▲	590564 ▲			

											TC	i	Valeo					
A13N187	2	14	60	1200	53	61		CW	G	20	1	YV1652	INC	590558		92968		180593
A13N188+	2	14	70	1200	60	71		CW	G	20	1	YV1652	INC	590558			592830	180593
A13N189	2	28	40	1500	30	39	⊕	DS										593199
A13N190	2	28	40	1500	30	39		DS										593199
A13N198+	2	14	80	1630	64	80		DS			/ W	YV1903	INC	182007				593199
A13N199+	2	14	70	1200	61	71		CW	GD		1	YV1652	INC	590558	590625	592830	180593	
A13N200+	2	14	70	1200	60	71		CW	D	60	1	YV1652	INC	590558		592830		
A13N201+	2	14	70	1200	60	71		CW	D	60	1	YV1652	INC	590558		592830		
A13N203	2	14	60	1200	53	61		CW	D	20	16	YV1652	INC	590558	590639			180593
A13N204+	2	14	70	1200	61	71		CW	D	20	1	YV1652	INC	590558	590625	592830	180593	
A13N206+	2	14	70	1200	61	71		CW	GD		1	YV1652	INC	590558	590625	592830	180593	
A13N207+	2	14	70	1200	60	69		CW	D	20	5 / W	YV1925	INC	182120	590625	592830	592951	
A13N209	2	14	60	1200	53	61		CW	GD		1	YV1652	INC	590558	92968			
A13N210	2	14	50	1000	43	50		CW	D	60	1	YV1652	INC	590558	92968	100930	180593	
A13N214	2	14	60	1200	53	61		CW	G	20	5	YV1925	INC	182120	92968			592840
A13N215	2	14	50	1000	38	49		CW	D	60	5	YV1925	INC	182120	300846	100930	592877	
A13N216+	2	14	70	1050	52	69		CW	D	60	5	YV1925	INC	182120		592830	592877	
A13N217+	2	14	70	1050	52	69		CW	D	20		YV1926T	INC	590688	590625	592830	592878	
A13N218	2	14	50	1000	38	50		CW	D	20	5	YV1925	INC	182120	590639	100930	592749	
A13N219	2	14	50	1000	38	50		CW	D	20	5	YV1925	INC	182120	590639	100930	592749	
A13N220+	2	14	70	1050	52	69		CW	D	20	5	YV1925	INC	182120	590625	592830	592749	
A13N221	2	14	50	1000	38	50		CW	D	20	5	YV1925	INC	182120	92968	100930		
A13N226	2	14	60	1200	53	61		CW	GD		1	YV1652	INC	590558	92968		180593	
A13N229T	2	28	40	1500	30	40		CW	D	20	/ W					101339	101342	
A13N230+	2	14	70	1200	61	71		CW	GD		1 / W	YV1652	INC	590558	590625	592830		
A13N231	2	14	60	1200	53	61		CW	GD		5	YV1925	INC	182120	92968			
A13N233+	2	14	70	1200	61	71		CW	GD		5	YV1925	INC	182120		592830	593180	
A13N234	2	14	60	1200	53	61		CW	G	20	8 / W	YV7736	INC	593135			593309	
A13N235+	2	14	70	1200	61	71		CW	GD		1 / W	YV1652	INC	590558	590625	592830	592880	
A13N236M	2	28	35	1250	29	36		DS	GD	60	/ W						592882	
A13N237	2	14	50	1000	42	48		CCW	G	45	5	YV1924	INC	593191		100930	592877	
A13N238+	2	14	70	1200	56	66		CCW	GD		5	YV1924	INC	593191		592830		
A13N239+	2	14	70	1100	60	69		CW	D	20	5	YV1925	INC	182120		592830	592877	
A13N240	2	14	50	1000	42	49		CW	D	20	5	YV1925	INC	182120	590639	100930	592749	
A13N241+	2	14	70	1200	61	71		CW	GD		5	YV1925	INC	182120		592830	593180	
A13N242+	2	14	70	1200	61	71		CW	GD		5	YV1925	INC	182120		592830	593180	
A13N243CKD	2	14	50	1000	43	50		CW	D	20	5	YV1925	INC	182120	92968	100930	592840	
A13N244	2	14	60	1100	53	65		CW	G	60		YV1925	INC	182120	92968		105754	
A13N245+	2	14	70	1100	56	68		CW	D	20	5 / W	YV1924	INC	593191		592830	593182	
A13N247+	2	14	70	1100	61	69		CCW	G	55	5	YV1925	INC	182120		592830	592749	
A13N255	2	14	60	1200	51	60		DS			/ W	YV1903	INC	182007	593265	593278	593199	
A13N257	2	28	40	1400	29	38		DS			/ W			593265	101339	593199		
A13N258+	2	14	80	1300	64	80		DS			/ W	YV1903	INC	182007			593199	
A13N259	2	14	50	1000	39	46	⊕	CW	G	20	8 / W	YV7736	INC	593135	300846		593199	
A13N260	2	14	70	1200	56	66		CCW	G	45	5	YV1924	INC	593191		592830		
A13N261	2	14	50	1000	42	49		CW	D	20	5	YV1925	INC	182120	590639	100930	592749	
A13N262	2	14	50	1000	39	46		CW	GD		5 / W	YV1925	INC	182120	92968	100930	593182	
A13N263	2	14	50	1000	39	46		CW	GD		5 / W	YV1925	INC	182120	92968	100930	593178	
A13N269	2	14	60	1200	53	61		CW	G	11	5	YV1925	INC	182120	300846		592749	
A13N270	2	28	40	1500	30	40	⊕	CW	G	20	8 / W	ZV3736	INC	593136		101339		
A13N271	2	14	60	1200	51	60		DS			5 / W	YV1925	INC	182120	593270	593278	593199	
A13N272	2	28	40	1500	29	38		DS			5 / W	ZV3925	INC	593835	593270	101339	593199	
A13N273+	2	14	80	1300	64	80		DS			5 / W	YV1925	INC	182120			593199	
A13N274+	2	14	70	1100	56	68		CW	G	60	5 / W	YV1924	INC	593191		592830	593183	
A13N275+	2	14	70	1100	56	68		CW	GD		5 / W	YV1924	INC	593191		592830	593183	
A13N276+	2	14	70	1100	56	68		CW	G	60	5 / W	YV1924	INC	593191		592830	593183	
A13N277	2	14	50	1000	39	46		CW	D	20	5 / W	YV1924	INC	593191	92968	100930	593187	
A13N278+	2	14	70	1200	55	65		CW	D	20	5 / W	YV1924	INC	593191		592830	593182	
A13N279+	2	14	70	1200	55	65		CW	D	20	5 / W	YV1924	INC	593191		592830	593182	
A13N280+	2	14	70	1200	55	65		CW	D	20	5 / W	YV1924	INC	593191		592830	593182	
A13N281	2	14	50	1000	45	54		DS			/ W	YV1906	INC	593129		100930	593199	
A13N282	2	28	40	1500	31	41		DS								101339	593199	
A13N283M	2	28	40	1500	30	40	⊕	CW	D	20	/ W					101339	593188	
A13N284+	2	14	70	1200	61	71		CW	GD		5 / W	YV1925	INC	182120	590625	592830	593187	

TC	09	09a	11	11c	12	13	33	15	21	22	24	25	26	30
A13N187			593253										590564 ▲	590627 ▲
A13N188+			593253										590564 ▲	590627 ▲
A13N189								518611		590619 ▲				590627 ▲
A13N190								518611		590619 ▲				590627 ▲
A13N198+								518611		590619 ▲				590627 ▲
A13N199+										590568 ▲	590564 ▲			590627 ▲
A13N200+			592757							590568 ▲	590564 ▲	593230 ●	590627 ▲	
A13N201+										590568 ▲	590564 ▲	593230 ●	590627 ▲	
A13N203	593243									590568 ▲	590564 ▲			590627 ▲
A13N204+										590568 ▲	590564 ▲			590627 ▲
A13N206+			105760							590568 ▲	590564 ▲			590627 ▲
A13N207+			592760							590568 ▲				590627 ▲
A13N209			105760							590568 ▲	590564 ▲			590627 ▲
A13N210										590568 ▲	590564 ▲			590627 ▲
A13N214			96882							590568 ▲	590564 ▲			590627 ▲
A13N215										590568 ▲				590627 ▲
A13N216+										590568 ▲				590627 ▲
A13N217+			181485							590568 ▲				590627 ▲
A13N218										590568 ▲				590627 ▲
A13N219			592760							590568 ▲				590627 ▲
A13N220+										590568 ▲				590627 ▲
A13N221			593253							590568 ▲	590564 ▲			590627 ▲
A13N226			96882							590568 ▲	590564 ▲			590627 ▲
A13N229T									592860 ▲	590613 ▲	590564 ▲			590629 ▲
A13N230+										590568 ▲	590564 ▲			590627 ▲
A13N231					590553					590568 ▲	590564 ▲			590627 ▲
A13N233+			593215		590553					590568 ▲	590564 ▲			590627 ▲
A13N234										590568 ▲	590564 ▲			590627 ▲
A13N235+			105760							590568 ▲	590564 ▲			590627 ▲
A13N236M	92967								592780 ▲	590613 ▲				590629 ▲
A13N237					92477					590568 ▲	590564 ▲			590627 ▲
A13N238+			507050							590568 ▲				590627 ▲
A13N239+			593253							590568 ▲	590564 ▲			590627 ▲
A13N240										590568 ▲	590564 ▲			590627 ▲
A13N241+										590568 ▲	590564 ▲			590627 ▲
A13N242+			593215							590568 ▲	590564 ▲			590627 ▲
A13N243CKD			593253							590568 ▲	590564 ▲			590627 ▲
A13N244			593209							590568 ▲				590627 ▲
A13N245+										590568 ▲	590564 ▲			590627 ▲
A13N247+			96879							590568 ▲	590564 ▲	593218		590627 ▲
A13N255								518611		590619 ▲				590627 ▲
A13N257								518611		590619 ▲				590627 ▲
A13N258+								518611		590568 ▲				590627 ▲
A13N259										590568 ▲				590627 ▲
A13N260					92477					590568 ▲				590627 ▲
A13N261					590553					590568 ▲	590564 ▲			590627 ▲
A13N262										590568 ▲	590564 ▲			590627 ▲
A13N263					590553					590568 ▲	590564 ▲			590627 ▲
A13N269			593912							590568 ▲				590627 ▲
A13N270										590568 ▲				590627 ▲
A13N271								518611		590619 ▲				590627 ▲
A13N272								518611		590619 ▲				590627 ▲
A13N273+								518611		590619 ▲				590627 ▲
A13N274+			593221								590564 ▲			590627 ▲
A13N275+			593222								590564 ▲			590627 ▲
A13N276+			593220								590564 ▲			590627 ▲
A13N277			593223							590568 ▲	590564 ▲			590627 ▲
A13N278+										590568 ▲	590564 ▲			590627 ▲
A13N279+			593254							590568 ▲	590564 ▲			590627 ▲
A13N280+										590568 ▲	590564 ▲			590627 ▲
A13N281										590619 ▲				590627 ▲
A13N282										590619 ▲				590627 ▲
A13N283M	92967								592860 ▲	590613 ▲	590564 ▲			590629 ▲
A13N284+			105760							590568 ▲	590564 ▲			590627 ▲

TC											TC	i	Valeo	03	04	05	07		
	02																		
A13N285M	2	14	60	1200	53	61		CW	G	20	/ W	YV7736	INC	593135					592754
A13N289	2	14	70	1200	61	71		CW	GD		5	YV1925	INC	182120			592830	593180	
A13N290	2	14	55	1200	53	61		CW	GD	60	5 / W	YV1924	INC	593191				593278	
A13N291+	2	14	70	1200	56	66		CCW	G	45	5 / W	YV1924	INC	593191		592813	592830	104269	
A13N293	2	14	50	1000	42	47		CCW	G	45	5	YV1924	INC	593191				100930	104269
A13N296	2	14	50	1000	42	47		CCW	GD		5	YV1924	INC	593191		92968	100930	104269	
A13N297	2	14	70	1200	56	66		CCW	GD		11	YV1924	INC	593191		592813	592830	104269	
A13N303	2	14	70	1000	43	49		CW	D	42	12	YV1925	INC	182120		92968	592830	593180	
A13N306	2	14	60	1100	53	65		CW	G	60	/ W	YV1925	INC	182120		92968	593278	593182	
A13V02	3	14	70	980	56	70		CW	G	60	6	YV0913H	INC	592792					
A13V05	3	14	55	770	49	62		CW	G	60	6	YV0913H	INC	592792					
A13V07	3	14	70	1050	56	70		CW	G	60	6	YV0913H	INC	592792					
A13V08	3	14	55	1000	49	60		CW	G	60	91	YV0913H	INC	592792					
A13VI10	4	14	80	800	74	87		CW	D	60	2 / W	YM9980	INC	593139		592818	592831	592917	
A13VI11	4	14	110	1200	86	108		CW	GD		199 / W					593298	592832	592846	
A13VI13	4	14	110	1200	86	108		CW	GD		16 / W					592818	592832	592846	
A13VI14	4	14	80	1000	70	82		CW	D	19	199 / W					592818	592831	592847	
A13VI16	4	14	80	1000	70	82		CW	D	19	199 / W					592818	592831	592847	
A13VI17	4	14	110	1200	86	108		CW	G	26	199 / W					592818	592832	592846	
A13VI18	4	14	95	1200	84	112		CW	G	60	41	YM9980	INC	593139		592818	592832	592915	
A13VI20	4	14	80	1000	70	82		CW	GD		199 / W					592818	592831	592847	
A13VI21	4	14	110	1200	86	108		CW	GD		199 / W					592818	592832	592846	
A13VI22	4	14	110	1200	86	108		CW	GD		/ W					592818	592832	592846	
A13VI23	4	14	80	1000	70	82		CW	G	27	199 / W					592818	592831	592847	
A13VI24	4	14	90					CW	G	60		YM194	INC	593131		592818	592831	592917	
A13VI25	4	14	110	1200	86	108		CW	D	19	199 / W					592818	592832	592846	
A13VI28	4	14	110	1200	86	108		CW	GD		16 / W					592818	592832	592846	
A13VI30	4	14	110	1200	86	108		CW	GD		16 / W					592818	592832	592846	
A13VI31	4	14	80	1000	60	82		CW	D	20		YM6952	INC	593350		592818	592831	592848	
A13VI32	4	14	110	1200	86	108		CW	G	25	199 / W					592818	592832	592846	
A13VI34	4	14	110	1200	86	108		CW	D	19	199 / W					592818	592832	592846	
A13VI35	4	14	110	1200	86	108		CW	D	19	199 / W					592818	592832	592846	
A13VI40	4	14	90	1200	73			CW	D	7288	122 / W	YM194	INC	593131				592832	592915
A13VI41	4	14	90	1200	73			CW	D	90	122 / W	YM194	INC	593131				592832	592915
A13VI44	4	14	90	1200	73			CW	D	90	122 / W	YM194	INC	593131				592832	592915
A13VI45	4	14	110	1200	86	108		CW	GD		199 / W					592818	592832	592846	
A13VI46	4	14	80	1000	60	82		CW	G	60		YM6952	INC	593350		592818	592831	593163	
A13VI47	4	14	110	1200	86	108		CW	GD		199 / W					592818	592832	592846	
A13VI48	4	14	80	1000	60	82		CW	D	20		YM6952	INC	593350		592818	592831	592848	
A13VI49	4	14	80	1000	60	82		CW	D	20		YM6952	INC	593350		592818	592831	593163	
A13VI51	4	14	80	1000	69	82		CW	D	20		YM6952	INC	593350		592818	592831	593163	
A13VI52	4	14	110	1200	86	108		CW	D	35	16 / W					592818	592832	592846	
A13VI54	4	14	80	1100	73	85		CW	G	32	3 / W	YM9980	INC	593139		592818	592831	592915	
A13VI55	4	14	110	1200	86	108		CW	G	25	199 / W					592818	592832	592846	
A13VI57	4	14	110	1200	86	108		CW	D	35	199 / W					592818	592832	592846	
A13VI59	4	14	100	1300	85	108		CW	G	32	3 / W	YM9980	INC	593139		592818	592832		
A13VI60	4	14	105	1300	86	108		CW	G	32	/ W	YM9980	INC	593139		592818	592832	592915	
A13VI61	4	14	80	1100	73	85		CW	G	60	/ W	YM9980	INC	593139		592818	592831	592915	
A13VI62	4	14	110	1200	86	108		CW	G	25	199 / W					592818	592832	592846	
A13VI63	4	14	90	1000	76	96		CW	D	90	2 / W	YM194	INC	593131				592832	593557
A13VI64	4	14	80	1000	70	82		CW	GD		199 / W					593298	592831	592847	
A13VI65	4	14	80	1000	70	82		CW	D	35	199 / W					593298	592831	592847	
A13VI66	4	14	80	900	70	82		CW	D	25	199 / W					592818	592831	592847	
A13VI67	4	14	90	1200	82	99		CW	G	60		YM194	INC	593131		592818	592832	592917	
A13VI68	4	14	80	900	69	82		CW	D	20						593298	592831	593163	
A13VI69	4	14	90	1200	82	98		CW	G	60	4	YM194	INC	593131		592818	592832	592917	
A13VI70	4	14	90	1200	82	98		CW	G	60	4	YM194	INC	593131		592818	592832	592917	
A13VI71	4	14	97	1000	86	97		CW	D	20						593147	593158	593163	
A13VI72	4	14	80	1000	76	89		CW	GD			YM6951	INC	593138		592818	592831	593166	
A13VI73	4	14	110	1100	87	116		CW	GD			YM6951	INC	593138		592818	592832	593167	
A13VI74	4	14	70	1200	68	78		CW	G	60	2	YM194	INC	593131		593145	592832	592917	
A13VI75	4	14	70	1200	68	78		CW	G	60		YM194	INC	593131		593145	592832	592917	
A13VI76	4	14	105	1200	84	112		CW	G	60	/ W	YM9980	INC	593139		593298			
A13VI77	4	14	90	1200	82	99		CW	G	60		YM194	INC	593131		592818	592832	592917	















TC														
A13N285M					590553					590568 ▲	590564 ▲		590627 ▲	
A13N289					590553					590568 ▲	590564 ▲		590627 ▲	
A13N290									592780 ▲		590564 ▲		590627 ▲	
A13N291+					92477					590568 ▲	590564 ▲		590627 ▲	
A13N293					92477					590568 ▲	590564 ▲		590627 ▲	
A13N296					590553					590568 ▲	590564 ▲		590627 ▲	
A13N297			507050							590568 ▲			590627 ▲	
A13N303					590553					590568 ▲	590564 ▲		590627 ▲	
A13N306			593209							590619 ▲				
A13V02														
A13V05														
A13V07										590613 ▲				
A13V08										590613 ▲				
A13VI10						592849			593563 ▲		593295 ▲			592854
A13VI11			592921			592852			593563 ▲	593564 ▲	592944 ▲			592854
A13VI13			96879			592852			593563 ▲		592945 ▲			592854
A13VI14			592924			592852			593563 ▲	593564 ▲	592944 ▲			592854
A13VI16						592852			593563 ▲	593564 ▲	592944 ▲			592854
A13VI17			592927			592852			593563 ▲	593564 ▲	592944 ▲			592854
A13VI18						592849			593563 ▲		592941 ▲			592854
A13VI20			592923			592852			593563 ▲	593564 ▲	592944 ▲			592854
A13VI21			592923			592852			593563 ▲	593564 ▲	592944 ▲			592854
A13VI22			593738			592852			593563 ▲	593564 ▲				592854
A13VI23			592921			592852			593563 ▲	593564 ▲	592944 ▲			592854
A13VI24						592850			593563 ▲					592854
A13VI25			592925			592852			593563 ▲	593564 ▲	592944 ▲			592854
A13VI28			593737			592852			593563 ▲	593564 ▲	592945 ▲			592854
A13VI30						592852			593563 ▲	593564 ▲	592945 ▲			592854
A13VI31						592853			593563 ▲	593564 ▲				592854
A13VI32			592921			592852			593563 ▲	593564 ▲	592944 ▲			592854
A13VI34						592852			593563 ▲	593564 ▲	592944 ▲			592854
A13VI35			592926			592852			593563 ▲	593564 ▲	592944 ▲			592854
A13VI40						592933			593563 ▲	593564 ▲	593241 ▲			592854
A13VI41						592933			593563 ▲		593241 ▲			592854
A13VI44						592933			593563 ▲		593241 ▲			592854
A13VI45						592852			593563 ▲	593564 ▲	592944 ▲			592854
A13VI46			592929			592851			593563 ▲	593564 ▲				592854
A13VI47			593739			592852			593563 ▲	593564 ▲	592944 ▲			592854
A13VI48			593741			592853			593563 ▲					592854
A13VI49						592851			593563 ▲	593564 ▲				592854
A13VI51			593743			592851			593563 ▲	593564 ▲				592854
A13VI52						592852			593563 ▲	593564 ▲	592945 ▲			592854
A13VI54						592934			593563 ▲	593564 ▲	592947			592854
A13VI55			593740			592852			593563 ▲	593564 ▲	592944 ▲			592854
A13VI57						592852			593563 ▲	593564 ▲	592944 ▲			592854
A13VI59									593563 ▲	593564 ▲				592854
A13VI60						592934			593563 ▲	593564 ▲	595260			592854
A13VI61						592849			593563 ▲	593564 ▲	593252 ▲			592854
A13VI62			593750			592852			593563 ▲	593564 ▲				592854
A13VI63									593563 ▲		593295 ▲			592854
A13VI64						592852			593563 ▲	593564 ▲	592944 ▲			592854
A13VI65						592852			593563 ▲	593564 ▲	592944 ▲			592854
A13VI66			593750			592852			593563 ▲	593564 ▲				592854
A13VI67						592850			593674 ▲		593295 ▲			592854
A13VI68			593742			592851			593563 ▲	593564 ▲				592854
A13VI69						592850			593674 ▲	593564 ▲	593295 ▲			592854
A13VI70			593719						593563 ▲	593564 ▲	592949			592854
A13VI71			593702			592851			593674 ▲	593564 ▲				592854
A13VI72			593701						593563 ▲	593564 ▲	593238 ▲			592854
A13VI73			593701						593563 ▲	593564 ▲	593238 ▲			592854
A13VI74							593233		593674 ▲		593235 ▲			592854
A13VI75							593233		593674 ▲		593235 ▲			592854
A13VI76									593563 ▲	593564 ▲				592854
A13VI77						592850			593674 ▲		593295 ▲			592854

TC															03	04	05	07
	TC	i	Valeo															
A13VI78	4	14	80	1100	72	85		CW	D	35	3	YM9980	INC	593139		593298	592831	
A13VI80	4	14	80	900	69	82		CW	D	20						593298	592831	593163
A13VI81	4	14	80	1000	69	82		CW	D	20						593298	592831	593163
A13VI82	4	14	105	1200	86	108		CW	G	32	41	YM3617P1C	INC	599145		592818	592832	
A13VI83	4	14	80	1000	69	82		CW	G	60		YM6952	INC	593350		592818	592831	593163
A13VI84	4	14	80	1000	69	82		CW	G	55		YM6952	INC	593350		593298	592831	593163
A13VI85	4	14	80	1000	69	82		CW	D	20						593298	592831	592848
A13VI86	4	14	80	1000	69	82		CW	D	20						593298	592831	592848
A13VI87	4	14	80	1000	69	82		CW	D	20		YM6952	INC	593350		593298	592831	593163
A13VI88	4	14	80	1000	69	82		CW	D	20		YM6952	INC	593350		593298	592831	593163
A13VI94	4	14	90	1000	85	97		CW	G	45		YM6952	INC	593350		593147	593158	592848
A13VI95	4	14	80	1000	69	82		CW	G	45		YM6952	INC	593350		593298	592831	592848
A13VI96	4	14	80	1000	69	82		CW	G	60		YM6952	INC	593350		593298	592831	593163
A13VI97	4	14	95	1100	83	100		CW	G	60	41					593298	592832	593201
A13VI99	4	14	90	1250	80	92		CW	G	60		YM194	INC	593131		593145	592832	592917
A13VI100	4	14	90	1250	80	92		CW	G	60	2	YM194	INC	593131		593145	592832	592917
A13VI101	4	14	90	1000	86	97		CW	G	45		YM6952	INC	593350		593147	593158	592848
A13VI102	4	14	80	1000	69	82		CW	G	45		YM6952	INC	593350		593298	592831	592848
A13VI104	4	14	80	1000	70	82		CW	D	19	199 / W					593298	592831	592847
A13VI105	4	14	110	1200	86	110		CW	D	19	201					593298	592832	592846
A13VI106	4	14	110	1200	86	110		CW	G	27	199 / W					593298	592832	592846
A13VI107	4	14	110	1200	86	110		CW	GD		199 / W					593298	592832	592846
A13VI108	4	14	80	1000	69	82		CW	D	20						593298	592831	593163
A13VI109	4	14	80	1000	69	82		CW	D	20						593298	592831	593163
A13VI113	4	14	110	1200	86	111		CW	GD		3 / W	YM194	INC	593131		593298	592832	
A13VI114	4	14	90	1100	82	99		CW	D	90	122 / W	YM194	INC	593131		593298	592832	592915
A13VI116	4	14	80	1000	67	84		CW	G	60	4	YM194	INC	593131		593298	592831	592915
A13VI117	4	14	110	1200	84	105		CW	GD		3 / W	YM1601T	INC	593141		593298	592832	593172
A13VI118	4	14	120	1300	94	130		CW	G	13	3 / W	YM1601T	INC	593141		593147	593161	593174
A13VI119	4	14	80					CW	G	30	41	YM3617P1C	INC	599146		593298	592831	
A13VI121	4	14	90	1100	82	99		CW	D	90	122 / W	YM194	INC	593131		593298	592832	592915
A13VI122	4	14	110	1200	86	110		CW	GD		3 / W	YM1601T	INC	593141		593298	592832	593172
A13VI123	4	14	90	1200	82	98		CW	D	7288	122 / W	YM194	INC	593131		593298	592832	592915
A13VI124	4	14	90	1200	82	98		CW	D	90	122 / W	YM194	INC	593131		593298	592832	592915
A13VI125	4	14	90	1200	82	98		CW	D	90	122 / W	YM194	INC	593131		593298	592832	592915
A13VI126	4	14	90	1100	82	98		CW	D	90	2 / W	YM194	INC	593131		593298	592832	593557
A13VI130	4	14	95					CW	G	60	41	YM3617P1C	INC	599147		593298	592832	593204
A13VI131	4	14	110	1200	85	110		CW	D	35	2 / W					593298	592832	592846
A13VI132	4	14	80					CW	G	30	4 / W	YM9980	INC	593139		593298	592831	592915
A13VI134	4	14	90	1200	77	93		CW	G	60		YM194	INC	593131		593298	592832	592917
A13VI135	4	14	90	1200	77	92		CW	G	60	2	YM194	INC	593131		593298	592832	592917
A13VI137	4	14	90	1200	82	98		CW	D	90	4	YM194	INC	593131		593298	592832	592917
A13VI138	4	14	90	1200	82	98		CW	G	60	4	YM194	INC	593131		593298		592917
A13VI139	4	14	110	1200	86	110		CW	GD		12 / W	YM1601T	INC	593141		593298	592832	593172
A13VI140	4	14	115		95	119		CW	G	32	4 / W	YM9980	INC	593139		593147	593161	592915
A13VI141	4	14	90	1000	86	97		CW	G	60		YM6952	INC	593350		593147	593158	593163
A13VI142	4	14	95	1000	86	97		CW	G	55		YM6952	INC	593350		593147	593158	593163
A13VI148	4	14	110	1200	86	110		CW	GD		12 / W	YM1601T	INC	593141		593298	592832	593172
A13VI149	4	14	80	1000	70	82		CW			12 / W	YM1601T	INC	593141		593298	592831	593175
A13VI150	4	14	95		82	98		CW	G	60	41	YM36 9RC7176	INC	593333		593298	592832	593204
A13VI151+	4	14	120	1400	90	126		CW	G	13	3 / W	YM1606P1	INC	593318		593147	593161	593174
A13VI152	4	14	80	1000	70	82		CW	G	13	3 / W	YM10607P	INC	593305		593298	592831	593306
A13VI153	4	14	110	1600	84	110		CW	D	35	199 / W					593298	592832	592846
A13VI155	4	14	90	1200	82	98		CW	G	60	4	YM194	INC	593131		593298	592832	592917
A13VI156	4	14	90	1200	82	98		CW	G	60	4	YM194	INC	593131		593298	592832	592917
A13VI157	4	14	110	1200	86	110		CW	GD		199 / W	YM1600	INC	593290		593298	592832	593299
A13VI160	4	14	90					CW	G	30	41	YM36 9RC7176	INC	593333		593298	592832	593204
A13VI163	4	14	110	1200	86	110		CW	G	25	199 / W	YM1600	INC	593290		593298	592832	593299
A13VI164	4	14	110	1200	86	110		CW	D	35	200 / W	YM1600	INC	593290		593298	592832	593172
A13VI165	4	14	80	1100	68	82		CW	GD		200 / W	YM1413	INC	593310		593298	592831	593175
A13VI166	4	14	80	1000	70	82		CW	D	35	199 / W	YM1600	INC	593290		593298	592831	593175
A13VI167	4	14	110	1200	86	110		CW	D	35	199 / W	YM1600	INC	593290		593298	592832	593172
A13VI170	4	14	90	1200	77	93		CW	G	60		YM6952	INC	593350		593145	592832	592917
A13VI173	4	14	90	1200	82	99		CW	G	60	4	YM194	INC	593131		593298	592832	592917















TC	09	09a	11	11c	12	13	33	15	21	22	24	25	26	30
A13VI78									593563 ▲	593564 ▲	593234 ▲			592854
A13VI80			593744				592851		593563 ▲	593564 ▲				592854
A13VI81			593702				592851		593674 ▲	593564 ▲				592854
A13VI82							592852		593563 ▲	593564 ▲				592854
A13VI83			592929				592851		593563 ▲					592854
A13VI84			593742				592851		593563 ▲	593564 ▲				592854
A13VI85							592853		593563 ▲	593564 ▲				592854
A13VI86			593741				592853		593563 ▲	593564 ▲				592854
A13VI87							592851		593563 ▲	593564 ▲				592854
A13VI88			593743				592851		593563 ▲	593564 ▲				592854
A13VI94			593745				592853		593674 ▲	593564 ▲				592854
A13VI95			593745				592853		593674 ▲	593564 ▲				592854
A13VI96			592929				592851		593563 ▲	593564 ▲				592854
A13VI97							592852		593563 ▲	593564 ▲	593244 ▲			592854
A13VI99							593233		593674 ▲		593235 ▲			592854
A13VI100							593233		593674 ▲		593235 ▲			592854
A13VI101			593702				592853		593674 ▲	593564 ▲				592854
A13VI102			593702				592853		593674 ▲	593564 ▲				592854
A13VI104			593746				592852		593563 ▲	593564 ▲	592944 ▲			592854
A13VI105			593746				592852		593563 ▲	593564 ▲	592944 ▲			592854
A13VI106			593543				592852		593563 ▲	593564 ▲	592944 ▲			592854
A13VI107			593747				592852		593563 ▲	593564 ▲	592944 ▲			592854
A13VI108			593742				592851		593563 ▲	593564 ▲				592854
A13VI109			593744				592851		593563 ▲	593564 ▲				592854
A13VI113			593215						593563 ▲	593564 ▲				592854
A13VI114			593615				592933		593563 ▲	593564 ▲	593241 ▲			592854
A13VI116			593722				592850				593295 ▲			592854
A13VI117									593563 ▲	593564 ▲	593242 ▲			592854
A13VI118									593563 ▲	593564 ▲	593249 ▲			592854
A13VI119							592852		593563 ▲	593564 ▲				592854
A13VI121							592933		593563 ▲	593564 ▲	593241 ▲			592854
A13VI122			593215						593563 ▲	593564 ▲	593242 ▲			592854
A13VI123							592933		593563 ▲	593564 ▲	593241 ▲			592854
A13VI124							592933		593563 ▲	593564 ▲	593241 ▲			592854
A13VI125							592933		593563 ▲	593564 ▲	593241 ▲			592854
A13VI126							592850		593563 ▲	593564 ▲	593295 ▲			592854
A13VI130							592852							592854
A13VI131							592852		593563 ▲	593564 ▲	592944 ▲			592854
A13VI132							592934		593563 ▲		592947			592854
A13VI134							593233		593674 ▲	593564 ▲				592854
A13VI135							593233		593674 ▲	593564 ▲	593235 ▲			592854
A13VI137							592850		593563 ▲	593564 ▲	593295 ▲			592854
A13VI138							592850		593674 ▲	593564 ▲	593295 ▲			592854
A13VI139									593563 ▲	593564 ▲	593242 ▲			592854
A13VI140							592934		593563 ▲	593564 ▲	595260			592854
A13VI141			592929				592851		593563 ▲	593564 ▲				592854
A13VI142			593742				592851		593563 ▲	593564 ▲				592854
A13VI148									593563 ▲	593564 ▲	593242 ▲			592854
A13VI149									593563 ▲	593564 ▲	593242 ▲			592854
A13VI150									593563 ▲	593564 ▲				592854
A13VI151+									593563 ▲	593564 ▲	593307 ▲			592854
A13VI152									593563 ▲	593564 ▲	593307 ▲			592854
A13VI153							592852		593563 ▲	593564 ▲	592944 ▲			592854
A13VI155			593719				592850		593563 ▲	593564 ▲	593295 ▲			592854
A13VI156							592850		593563 ▲	593564 ▲	593295 ▲			592854
A13VI157			592921						593563 ▲	593564 ▲	593291 ▲			592854
A13VI160									593563 ▲	593564 ▲				592854
A13VI163			593740						593563 ▲	593564 ▲	593291 ▲			592854
A13VI164									593563 ▲	593564 ▲	593291 ▲			592854
A13VI165									593563 ▲	593564 ▲	593291 ▲			592854
A13VI166									593563 ▲	593564 ▲	593291 ▲			592854
A13VI167									593563 ▲	593564 ▲	593291 ▲			592854
A13VI170							593233		593674 ▲		593235 ▲			592854
A13VI173							592850		593563 ▲	593564 ▲	593295 ▲			592854









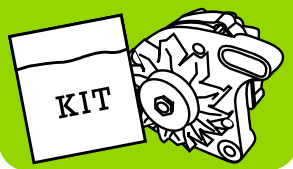

A13VI175	4	14	90	1200	77	93		CW	G	60		YM6952	INC	593350		593145	592832	592917
A13VI176	4	14	90	1200	77	93		CW	G	60		YM6952	INC	593350		593145	592832	592917
A13VI178	4	14	90	1200	80	92		CW			/ W	YM1619P1	INC	593319		593298	592832	593320
A13VI179	4	14	110	1200	86	110		CW	GD		201 / W	YM1600	INC	593290		593298	592832	593329
A13VI180	4	14	115		95	115		CW	G	32	4 / W	YM9980	INC	593139		593147	593161	592917
A13VI181	4	14	90	1200	82	98		CW	D	90	30	RC9101	INC	593362		593298	592832	593364
A13VI184	4	14	80	1100	70	82		CW	D	19	200 / W	YM1413	INC	593310		593298	592831	593304
A13VI185	4	14	110	1200	86	110		CW	D	19	200 / W	YM1600	INC	593290		593298	592832	593299
A13VI188	4	14	110	1200	86	110		CW	G	30	21 / W	YM1662P	INC	593411		593298	592832	593327
A13VI189	4	14	80	1000	69	82		CW	D	20		YM6952	INC	593350		593298	592831	593163
A13VI190	4	14	90					CW	G	60	41	YM36 9RC7176	INC	593333		593298	592832	593204
A13VI191	4	14	97	1000	86	97		CW	D	20		YM6952	INC	593350		593147	593158	593163
A13VI192+	4	14	105	1100	89	110		CW	D	60	127	YM2621P2	INC	593342		593147	593158	593327
A13VI193+	4	14	105	1100	89	111		CW	GD		127	YM2621P2	INC	593342		593147	593158	593327
A13VI194+	4	14	105	1100	89	111		CW	D	55		YM2621P2	INC	593342		593147	593158	593327
A13VI195	4	14	110	1200	86	111		CW	G	26	21 / W	YM1662P	INC	593411		593298	592832	593327
A13VI197	4	14	90	1200	77	93		CW	G	60		YM194	INC	593131		593298	592832	592917
A13VI198	4	14	90	1200	77	93		CW	G	60	2	YM194	INC	593131		593298	592832	592917
A13VI200	4	14	100					CW	G	60	41	YM36 9RC7176	INC	593333		593147	593161	593204
A13VI201	4	14	120	1300	94	130		CW	G	40		YM1600	INC	593290		593147	593161	
A13VI202	4	14	90	1200	77	92		CW				YM1619P1	INC	593319		593298	592832	593320
A13VI203	4	14	80	1000	68	80		CW	G	40		YM6952	INC	593350			593579	592848
A13VI204	4	14	90	1000	85	97		CW	G	40		YM6952	INC	593350		593147	593158	592848
A13VI207	4	14	120	1400	96	126		CW	D	35	201 / W	YM1600	INC	593290		593325	593161	593324
A13VI208	4	14	120	1400	98	126		CW	GD		201 / W	YM1600	INC	593290		593325	593161	593324
A13VI209	4	14	110	1200	86	111		CW	D	35	200 / W	YM1413	INC	593310		593298	592832	593172
A13VI210	4	14	110	1200	86	111		CW	D	35	199 / W	YM1600	INC	593290		593298	592832	593172
A13VI211	4	14	80	1100	70	82		CW	D	35	199 / W	YM1600	INC	593290		593298	592831	593175
A13VI212	4	14	80	1000	70	82		CW	D	19	200 / W	YM1413	INC	593310		593298	592831	593304
A13VI213	4	14	110	1200	86	110		CW	D	19	200 / W	YM1413	INC	593310		593298	592832	593299
A13VI216	4	14	110	1200	86	110		CW	GD		201 / W	YM1413	INC	593310		593298	592832	593172
A13VI217	4	14	80	1000	70	82		CW	GD		200 / W	YM1413	INC	593310		593298	592831	593175
A13VI218	4	14	110	1200	86	111		CW	G	26	201 / W	YM1413	INC	593310		593298	592832	593299
A13VI220	4	14	90	1200	77	93		CW	G	60		YM6952	INC	593350		593298	592832	592917
A13VI222	4	14	90	1200	77	93		CW	G	60	2	YM6952	INC	593350		593298	592832	592917
A13VI223	4	14	90	1200	82	98		CW	D	90	30	RC9101	INC	593362		593298	592832	593364
A13VI224	4	14	80	1000	70	82		CW	GD		201 / W	YM1413	INC	593310		593298	592831	593175
A13VI227	4	14	110	1200	86	111		CW	GD		201 / W	YM1413	INC	593310		593298	592832	593299
A13VI230	4	14	80	1000	69	82		CW	G	45		YM6952	INC	593350		593298	592831	592848
A13VI231	4	14	97	1000	85	97		CW	G	45		YM6952	INC	593350		593147	593158	592848
A13VI232	4	14	80	1000	69	82		CW	G	45		YM6952	INC	593350		593298	592831	592848
A13VI233	4	14	97	1000	86	97		CW	G	45		YM6952	INC	593350		593147	593158	592848
A13VI234	4	14	100		100			CW	G	35	41	YM36 9RC7176	INC	593333		593147		593204
A13VI235	4	14	80	1200	70	82		CW	G	25	21 / W	YM1662P	INC	593411		593298	592831	593204
A13VI236	4	14	80	1000	68	80		CW	G	40	22	YM6956	INC	593375			593579	592848
A13VI237	4	14	90	1200	78	92		CW				YM1619P1	INC	593319		593298	592832	593320
A13VI238	4	14	120	1200	98	126		CW	GD		21 / W	YM1662P	INC	593411		593325	593161	593174
A13VI241	4	14	90	1150	82	98		CW	D	7487	30 / W	RC9101	INC	593362		593298	592832	593366
A13VI242	4	14	97	1000	85	97		CW	G	40	22	YM6956	INC	593375		593147	593158	592848
A13VI243	4	14	120	1300	98	126		CW	G	60	2 / W	YM6952	INC	593350		593147	593161	593382
A13VI244	4	14	120	1300	98	124		CW	G	60	2 / W	YM6952	INC	593350		593147	593161	593382
A13VI246	4	14	97	1000	86	97		CW	G	60	22	YM6956	INC	593375		593147	593158	592848
A13VI249	4	14	120	1200	98	126		CW	D	35	21 / W	YM1662P	INC	593411		593325	593161	593174
A13VI251	4	14	110	1200	86	110		CW	D	35	21	YM1662P	INC	593411		593298	592832	593329
A13VI252	4	14	80	1000	70	82		CW	D	35	21 / W	YM1662P	INC	593411		593298	592831	593306
A13VI253	4	14	110	1200	86	110		CW	GD		21 / W	YM1662P	INC	593411		593298	592832	593329
A13VI254	4	14	120	1300	98	126		CW	D	35	201 / W	YM1413	INC	593310		593325	593161	593324
A13VI255	4	14	120	1300	98	126		CW	GD		201 / W	YM1413	INC	593310		593325	593161	593324
A13VI256	4	14	80	1000	69	82		CW	G	60	22	YM6956	INC	593375		593298	592831	592848
A13VI257	4	14	90	1200	78	92		CW	GD			YM1619P1	INC	593319		593298	592832	593320
A13VI258	4	14	97	1000	85	97		CW	G	45		YM6952	INC	593350		593147	593158	592848
A13VI259	4	14	110	1200	86	110		CW	G	25	21 / W	YM1662P	INC	593411		593298	592832	593327
A13VI260	4	14	80	1000	68	82		CW	G	45		YM6952	INC	593350		593298	592831	592848
A13VI261	4	14	97	1000	86	97		CW	G	53	/ W	YM6952	INC	593350		593147	593158	592848

TC														
A13VI175							593233		593563 ▲	593564 ▲	593235 ▲			592854
A13VI176							593233		593563 ▲		593235 ▲			592854
A13VI178									593563 ▲	593564 ▲	593322 ▲			592854
A13VI179			593701						593563 ▲	593564 ▲	593291 ▲			592854
A13VI180									593563 ▲	593564 ▲				592854
A13VI181											593367 ▲			592854
A13VI184			593746						593563 ▲	593564 ▲	593291 ▲			592854
A13VI185			593746						593563 ▲	593564 ▲	593291 ▲			592854
A13VI188			593751						593563 ▲	593564 ▲	593317 ▲			592854
A13VI189			593743				592851		593563 ▲	593564 ▲				592854
A13VI190			593727						593563 ▲	593564 ▲	593354 ▲			592854
A13VI191			593743				592851		593563 ▲	593564 ▲				592854
A13VI192+			593615						593563 ▲	593564 ▲				592854
A13VI193+			593714						593563 ▲	593564 ▲	593341 ▲			592854
A13VI194+			593715								593341 ▲			592854
A13VI195									593563 ▲	593564 ▲				592854
A13VI197							593233		593563 ▲	593564 ▲	593235 ▲			592854
A13VI198							593233		593563 ▲	593564 ▲	593235 ▲			592854
A13VI200			593727						593563 ▲	593564 ▲	593354 ▲			592854
A13VI201			593760						593674 ▲	593564 ▲				592854
A13VI202				588085					593563 ▲	593564 ▲	593322 ▲			592854
A13VI203			593519				592853		593563 ▲	593564 ▲				592854
A13VI204			593754				592853		593563 ▲	593564 ▲				592854
A13VI207									593563 ▲	593564 ▲	593315 ▲			592854
A13VI208									593563 ▲	593564 ▲	593315 ▲			592854
A13VI209									593563 ▲	593564 ▲	593315 ▲			592854
A13VI210									593563 ▲	593564 ▲	593315 ▲			592854
A13VI211									593563 ▲	593564 ▲	593315 ▲			592854
A13VI212			593746						593563 ▲	593564 ▲	593315 ▲			592854
A13VI213			593746						593563 ▲	593564 ▲	593315 ▲			592854
A13VI216									593563 ▲	593564 ▲	593315 ▲			592854
A13VI217									593563 ▲	593564 ▲	593315 ▲			592854
A13VI218			593543						593563 ▲	593564 ▲	593315 ▲			592854
A13VI220							593233		593563 ▲	593564 ▲	593235 ▲			592854
A13VI222				588044			593233		593563 ▲	593564 ▲	593235 ▲			592854
A13VI223									593563 ▲	593564 ▲	593367 ▲			592854
A13VI224									593563 ▲	593564 ▲	593315 ▲			592854
A13VI227			593747						593563 ▲	593564 ▲	593315 ▲			592854
A13VI230							592853		593563 ▲	593564 ▲				592854
A13VI231							592853		593563 ▲	593564 ▲				592854
A13VI232			593743				592853		593563 ▲	593564 ▲				592854
A13VI233			593743				592853		593563 ▲	593564 ▲				592854
A13VI234			593755						593563 ▲	593564 ▲	593352 ▲			592854
A13VI235			593751						593563 ▲	593564 ▲	593317 ▲			592854
A13VI236			593519				593377		593563 ▲	593564 ▲	593376 ▲			592854
A13VI237			593730						593563 ▲	593564 ▲	593322 ▲			592854
A13VI238									593563 ▲	593564 ▲	593374 ▲			592854
A13VI241									593563 ▲	593564 ▲	593367 ▲			592854
A13VI242			593754				593377		593563 ▲	593564 ▲	593376 ▲			592854
A13VI243			593721				593383		593563 ▲	593564 ▲	593295 ▲			592854
A13VI244			593734				593383		593563 ▲	593564 ▲	593295 ▲			592854
A13VI246			592929				593377		593563 ▲	593564 ▲	593376 ▲			592854
A13VI249									593563 ▲	593564 ▲	593374 ▲			592854
A13VI251									593563 ▲	593564 ▲	593374 ▲			592854
A13VI252									593563 ▲	593564 ▲	593374 ▲			592854
A13VI253									593563 ▲	593564 ▲	593374 ▲			592854
A13VI254									593563 ▲	593564 ▲	593315 ▲			592854
A13VI255									593563 ▲	593564 ▲	593315 ▲			592854
A13VI256			592929				593377		593563 ▲	593564 ▲	593376 ▲			592854
A13VI257				588083					593563 ▲	593564 ▲	593322 ▲			592854
A13VI258							592853		593563 ▲	593564 ▲				592854
A13VI259			593543						593563 ▲	593564 ▲	593374 ▲			592854
A13VI260			593735				592853		593563 ▲	593564 ▲				592854
A13VI261			593735				592853		593563 ▲	593564 ▲				592854

TC																		
	TC	i	Valeo															
A13VI262	4	14	80	1000	69	82		CW	G	45		YM6952	INC	593350		593298	592831	592848
A13VI263	4	14	97	1000	86	97		CW	G	45		YM6952	INC	593350		593147	593158	592848
A13VI264	4	14	110	1200	86	110		CW	GD		201 / W	YM1600	INC	593290		593298	592832	593172
A13VI265	4	14	110	1200	86	110		CW	D	35	201 / W	YM1600	INC	593290		593298	592832	593172
A13VI266	4	14	80	1000	70	82		CW	D	19	201	YM1600	INC	593290		593298	592831	593304
A13VI267	4	14	110	1200	86	110		CW	D	19	201	YM1600	INC	593290		593298	592832	593299
A13VI268	4	14	110	1200	86	110		CW	G	25	201 / W	YM1600	INC	593290		593298	592832	593299
A13VI269	4	14	110	1200	86	110		CW	GD		201 / W	YM1600	INC	593290		593298	592832	593299
A13VI273	4	14	97	1000	86	97		CW	G	55		YM6952	INC	593350		593147	593158	593163
A13VI274	4	14	97	1000	86	97		CW	G	53		YM6952	INC	593350		593147	593158	592848
A13VI276	4	14	80	1000	68	80		CW	G	40	22	YM6670VF	INC	593419			593579	593420
A13VI277	4	14	90	1000	87	97		CW	G	40	22	YM6670VF	INC	593419		593147	593158	593420
A13VI278	4	14	80	1000	68	80		CW	G	60	22	YM6670VF	INC	593419			593579	593420
A13VI279	4	14	97	1000	87	97		CW	G	60	22	YM6670VF	INC	593419		593147	593158	593420
A13VI280	4	14	80	1000	69	82		CW	D	20		YM6952	INC	593350		593298	592831	593163
A13VI281	4	14	97	1000	86	97		CW	D	20		YM6952	INC	593350		593147	593158	593163
A13VI283	4	14	90	1000	85	97		CW	G	40	22	YM6670VF	INC	593419		593147	593158	593420
A13VI284	4	14	120	1300	96	124		CW	G	50	2 / W	YM6952	INC	593350		593147	593161	593382
A13VI285	4	14	80	1000	70	82		CW	D	35	21 / W	YM1662P	INC	593411		593298	592831	593306
A13VI286	4	14	90					CW	G	40	41	YM36 9RC7176	INC	593333		593298	592832	593204
A13VI287	4	14	100					CW	G	40	41	YM36 9RC7176	INC	593333		593147	593158	593204
A13VI288	4	14	80	1000	68	80		CW	G	60	22	YM6670VF	INC	593419		593298	592831	593420
A13VI289	4	14	120	1300	98	126		CW	D	35	21	YM1662P	INC	593411		593147	593161	593174
A13VI290	4	14	120	1300	98	126		CW	D	35	21	YM1662P	INC	593411		593325	593161	593174
A13VI291	4	14	120	1300	98	126		CW	GD		21	YM1662P	INC	593411		593325	593161	593174
A13VI292	4	14	120	1400	98	126		CW	D	35	201 / W	YM1600	INC	593290		593325	593161	593324
A13VI293	4	14	120	1000	102	130		CW	D	90	122 / W	YM6952	INC	593350		593147	593161	593468
A13VI297	4	14	120	1200	98	126		CW	GD		21	YM1662P	INC	593411		593325	593161	593174
A13VI300	4	14	110	1600	86	111		CW	G	25	21 / W	YM1662P	INC	593411		593298	592832	593327
A13VI302	4	14	90	1200	71	91		CW	G	60	2 / W	YM194	INC	593131		593298	592832	593557
A13VI303	4	14	90	1200	71	91		CW	G	60	2 / W	YM194	INC	593131		593298	592832	593557
A13VI304	4	14	90	1200	72	91		CW	G	60	2 / W	YM194	INC	593131		593298	592832	593557
A13VI305	4	14	90	1200	71	91		CW	G	60	2 / W	YM194	INC	593131		593298	592832	593557
A13VI306	4	14	120	1300	94	126		CW	D	90	30	RC9101	INC	593362		593147	593161	593364
A13VI308	4	14	120	1000	97	122		CW	G	60	2 / W	YM194	INC	593131		593147	593161	593989
A13VI310	4	14	120	1000	97	122		CW	G	60	2 / W	YM194	INC	593131		593147	593161	593989

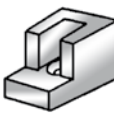
TC														
A13VI262			593763				592853		593563 ▲	593564 ▲				592854
A13VI263			593763				592853		593563 ▲	593564 ▲				592854
A13VI264									593563 ▲	593564 ▲	593315 ▲			592854
A13VI265									593563 ▲	593564 ▲	593315 ▲			592854
A13VI266			593746						593563 ▲	593564 ▲	593315 ▲			592854
A13VI267			593746						593563 ▲	593564 ▲	593315 ▲			592854
A13VI268			593543						593563 ▲	593564 ▲	593315 ▲			592854
A13VI269			593747						593563 ▲	593564 ▲	593315 ▲			592854
A13VI273			593764				592851		593563 ▲	593564 ▲				592854
A13VI274			593735				592853		593563 ▲	593564 ▲				592854
A13VI276			593519				593421		593563 ▲	593564 ▲	593376 ▲			592854
A13VI277			593754				593421		593563 ▲	593564 ▲	593376 ▲			592854
A13VI278			592929				593421		593563 ▲	593564 ▲	593376 ▲			592854
A13VI279			592929				593421		593563 ▲	593564 ▲	593376 ▲			592854
A13VI280			593743				592851		593563 ▲	593564 ▲				592854
A13VI281			593743				592851		593563 ▲	593564 ▲				592854
A13VI283			593769				593421		593563 ▲	593564 ▲	593376 ▲			592854
A13VI284			593766				593383		593563 ▲	593564 ▲	593295 ▲			592854
A13VI285				593515					593563 ▲	593564 ▲	593374 ▲			592854
A13VI286			593727						593563 ▲	593564 ▲	593354 ▲			592854
A13VI287			593727						593563 ▲	593564 ▲	593354 ▲			592854
A13VI288			592929				593421		593563 ▲	593564 ▲	593376 ▲			592854
A13VI289				593515					593563 ▲	593564 ▲	593374 ▲			592854
A13VI290									593563 ▲	593564 ▲	593374 ▲			592854
A13VI291									593563 ▲	593564 ▲	593374 ▲			592854
A13VI292				593515					593563 ▲	593564 ▲	593315 ▲			592854
A13VI293			592920						593563 ▲	593564 ▲	593241 ▲			592854
A13VI297				593515					593563 ▲	593564 ▲	593374 ▲			592854
A13VI300									593563 ▲	593564 ▲	593374 ▲			592854
A13VI302				588044			593233		593563 ▲	593564 ▲	593295 ▲			592854
A13VI303							593233		593563 ▲	593564 ▲	593295 ▲			592854
A13VI304							593233		593563 ▲	593564 ▲	593295 ▲			592854
A13VI305				588068			593233		593563 ▲	593564 ▲	593295 ▲			592854
A13VI306			593906						593563 ▲	593564 ▲	593367 ▲			592854
A13VI308							593233		593563 ▲	593564 ▲	593295 ▲			592854
A13VI310				588068			593233		593563 ▲	593564 ▲	593295 ▲			592854



	<p>1 Assembling Protector (For Brushes Protection) 1 protecteur de montage (protection des balais) 1 protector de montaje (protección de la escobillas) 1 protector de montagem (para protecção das escovas)</p>	<p>1 protezione montaggio (protezione spazzole) 1 Montage beschermmer (voor bescherming van koelborstels) 1 Montageschutz (für die Kohlen) 1 osłona kpl. (do ochrony szczotek)</p>	<p>1 montaj parçası (kömür koruma için) 1 сборочный протектор (для защиты щеток) 1 protector de montagem (para protecção das escovas)</p>
	<p>1 Rear Bearing Capsule 1 capsule de roulement arrière 1 cápsula de rodamiento trasero 1 cápsula de rolamento traseiro</p>	<p>1 capsula cuscinetti posteriore 1 kapje achterste lager 1 Lagerkapselung, hinten 1 kapsula tylnego łożyska</p>	<p>1 arka rulman kapsülü 1 капсула заднего подшипника 1 cápsula de rolamento traseiro</p>
	<p>4 Holding Nuts Of The Rectifier Bridge 4 écrous de maintien du pont redresseur 4 tuercas de fijación del puente de diodos 4 porcas de fixação da ponte de diodos</p>	<p>4 dadi di tenuta 4 Bevestigingsmoeren van diodebrug 4 Gleichrichter- Befestigungsschrauben 4 nakrętki mocujące mostek diodowy</p>	<p>4 diod köprüsü tutucu vidası 4 гайки диодного моста 4 porcas de fixação da ponte de diodos</p>
	<p>6 Grommets 6 passe-fils 6 pasa cables 6 abraçadeiras</p>	<p>6 gommini 6 Doorvoertules 6 Drahtdurchführungen 6 spinek</p>	<p>6 Kablo kovarı 6 резиновых втулок 6 abraçadeiras</p>
	<p>Centring screw Vis de centrage Tornillo de centrado Parafuso centrado</p>	<p>Vite di centraggio Centreerschroef Zentrierschraube Śruba centrująca</p>	<p>Merkezleme vidası Центрирующий болт Parafuso centrado</p>
	<p>4 Stator Clamping Flanges Of The Front Cap 4 brides de fixation stator sur capot avant 4 bridas de fijación stator sobre el capot delantero 4 falanges de fixação do estator na tampa dianteira</p>	<p>4 fori di fissaggio statore sul supporto anteriore 4 stator klemflenzen op voorste kap 4 Befestigungsflansch Stator/Vordere Abdeckung 4 nasadki mocujące stojan do przedniej obudowy</p>	<p>4 stator sabitleme ayağı 4 зажима статора к передней крышке 4 falanges de fixação do estator na tampa dianteira</p>
	<p>1 Connecting Screw (Brass) 1 vis de liaison (laiton) 1 tornillo de unión (latón) 1 parafuso de união (latão)</p>	<p>1 vite di fissaggio (ottone) 1 aansluitscroef (messing) 1 Verbindungsschraube (Messing) 1 złączeniowy wkręt (miedziany)</p>	<p>1 bağlama vidası (pirinç) 1 контактный болт (медь) 1 parafuso de união (latão)</p>
	<p>1 Plastic Centering Strip Rotor/Stator 1 bande plastique de centrage rotor/stator 1 banda plástica de centrado 1 banda de plástico de centragem</p>	<p>1 banda plastica di centraggio rotore/statore 1 kunststof centreerstrip voor rotor/stator Zentrierband Rotor/Stator 1 plastikowa taśma centrująca wirnik/stojan</p>	<p>1 plastik rotor/stator merkezleme şeridi 1 пластиковый якорь/статор с центрирующимися (встречными) лентами 1 banda de plástico de centragem</p>
	<p>1 340 Rhodorsyl Silicon Paste (Termal Conductivity) (Before Refitting, Coat The Baseplate Of The Rectifier Bridge) 1 tube de pâte silicone (conducteur thermique) 340 Rhodorsyl (Enduire la semelle du pont redresseur avant remontage) 1 tubo de silicona (conductor térmico) 340 Rhodorsyl (Dar la pasta a la placa de diodos antes del montaje) 1 tubo de silicone (conductor térmico) 340 Rhodorsyl (Aplicar na placa de diodos antes de montar)</p>	<p>1 tubetto di silicone 340 Rhodorsyl (conduttore termico) (Indurre la base della piastra diodi, prima di rimontarla) 1 Tube Rhodorsyl siliconen pasta (thermische geleiding) (Voor hermontage, de grondplaat van de diodebrug insmeren) 1 Silikonpaste. Den Sockel der Diodenplatte vor der Montage bestreichen 1 tubka silikonu przewodzącego ciepło (340 rhodorosylu) (przed montażem posmarować podstawę mostka diodowego)</p>	<p>1 tüp 340 Rhodorsyl silikon (ısı iletken) (tekrar takmadan önce diod köprüsü tabanının kaplamasını yapın) 1 Силиконовая паста Rhodorsyl (теплопроводность) (Перед переустановкой, покройте опорный диск диодного моста) 1 tubo de silicone (conductor térmico) 340 Rhodorsyl. Aplicar na placa de diodos antes de montar</p>
	<p>Plastic capsule Capsule plastique cápsula de plástico</p>	<p>Cápsula de plástico Capsula in plastica Kunststof kapje</p>	<p>Kunststoffabdeckung Plastikowa kapsula Plastik kapsül</p>
	<p>Wire shell Cosse Terminal stator</p>	<p>Terminal Guscio in ferro Kabelgoot</p>	<p>Kabelschuh Izolacja Kablo Korumucu</p>
	<p>Wire shell VI cosse VI Terminal stator</p>	<p>Terminal VI Guscio in ferro Kabelgoot</p>	<p>Kabelschuh Gr.6 Izolacja VI Kablo Korumucu</p>



# 1.3 A14N - A14R A14S - A14V - A14VI

## 5 A14N

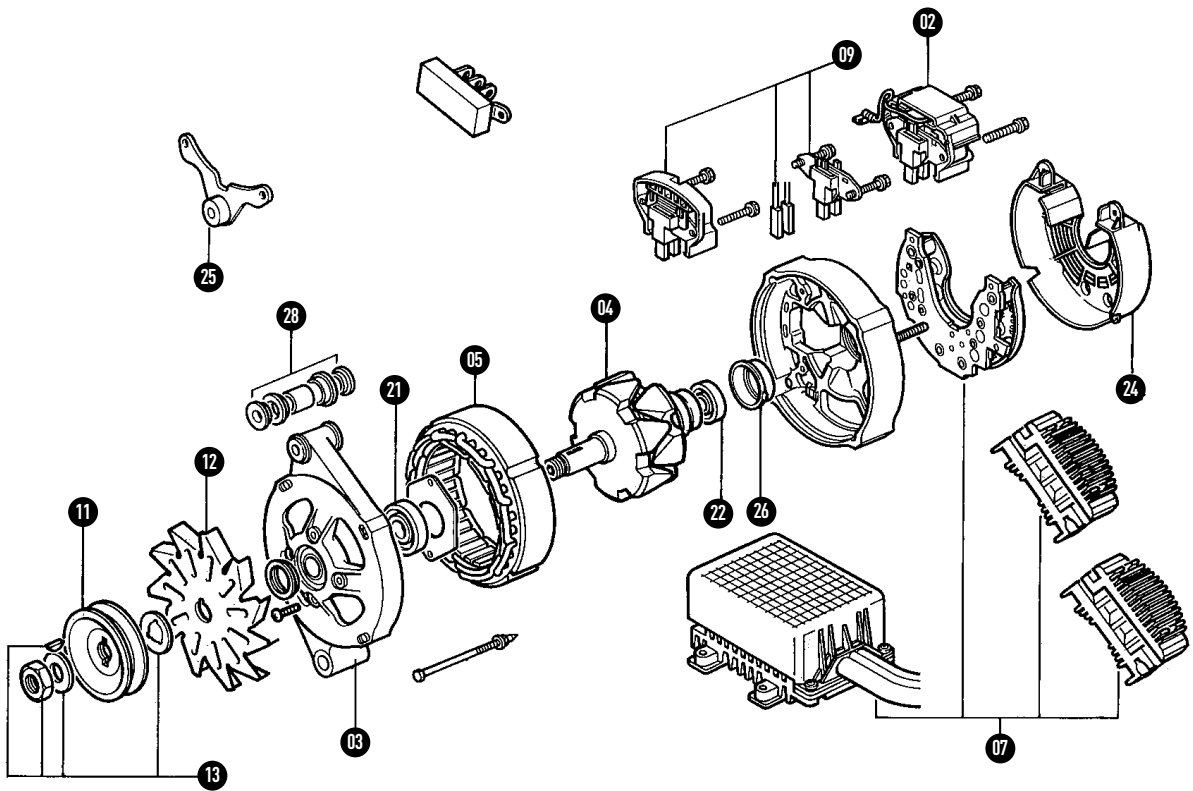

## 6 A14R

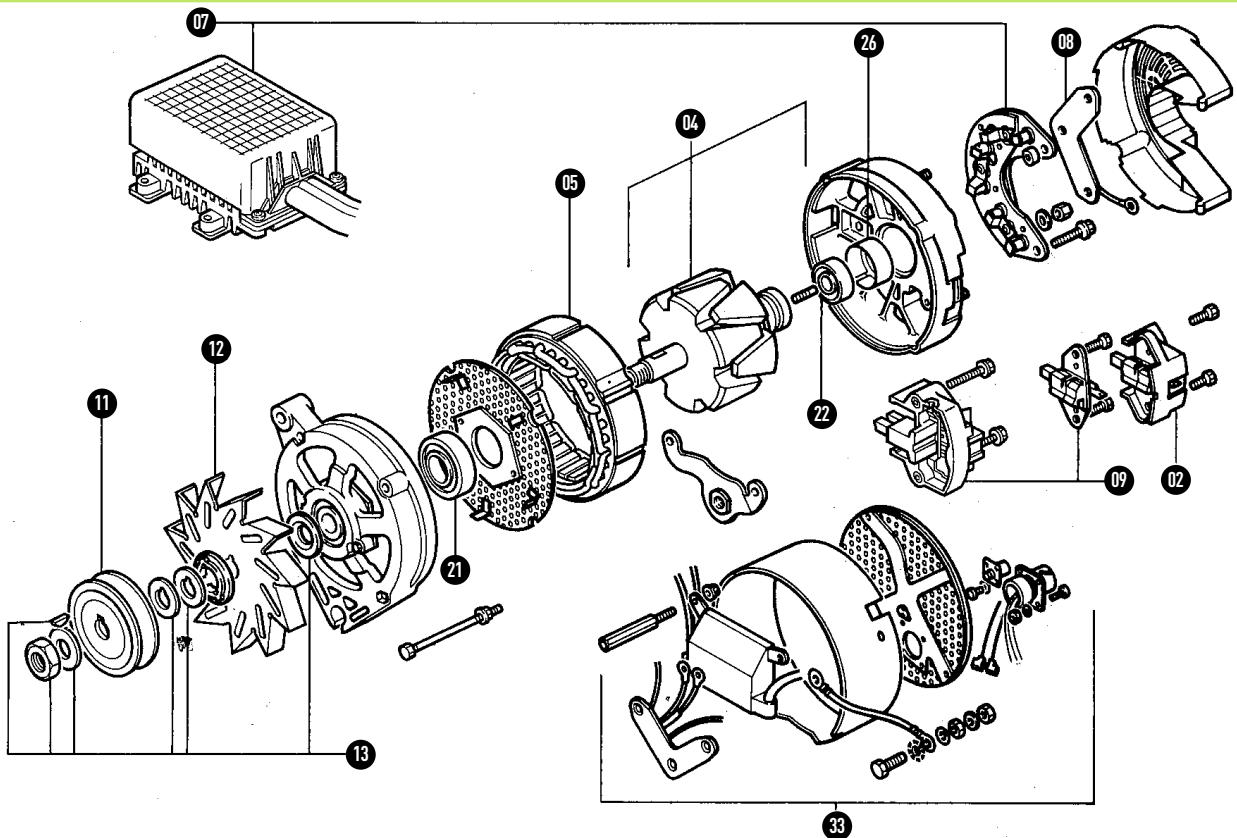

# A14N - A14R A14S - A14V - A14VI 1.3

## 7 A14V

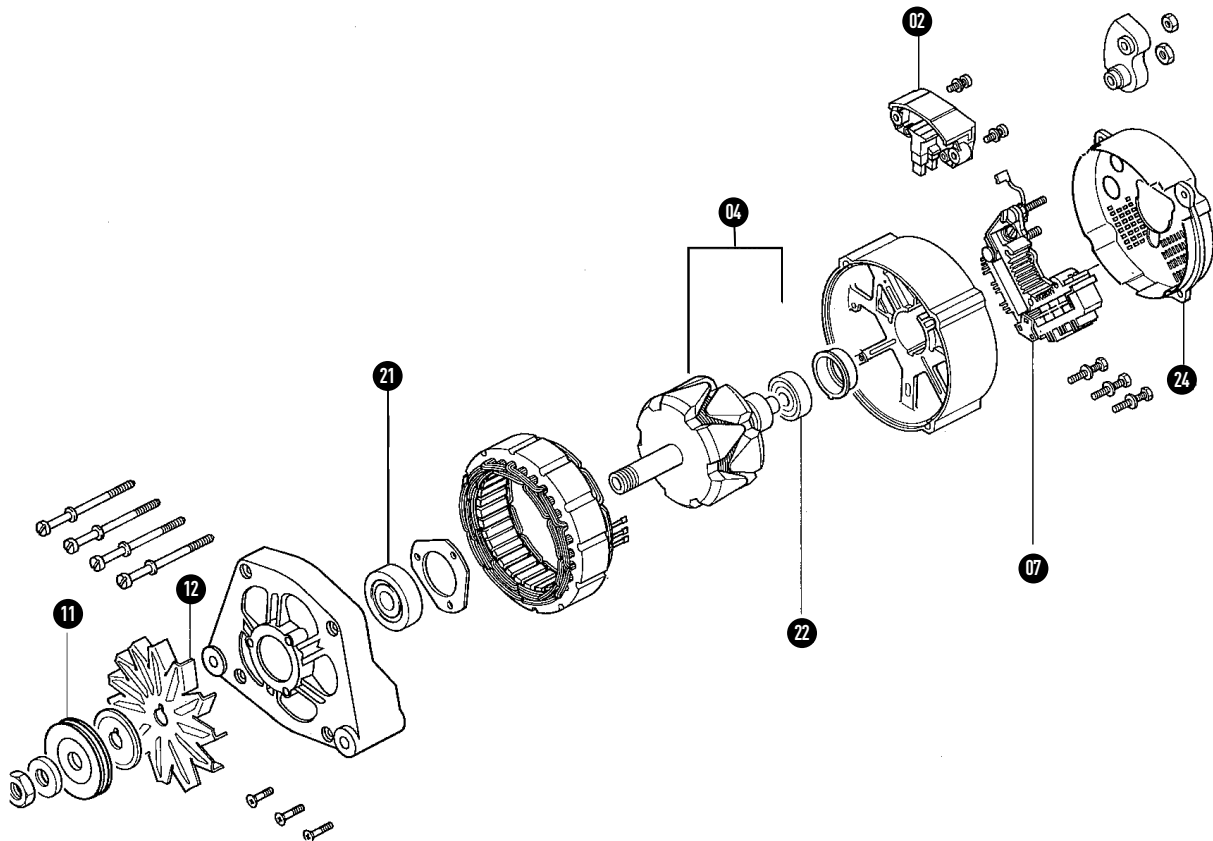

## 8 A14VI

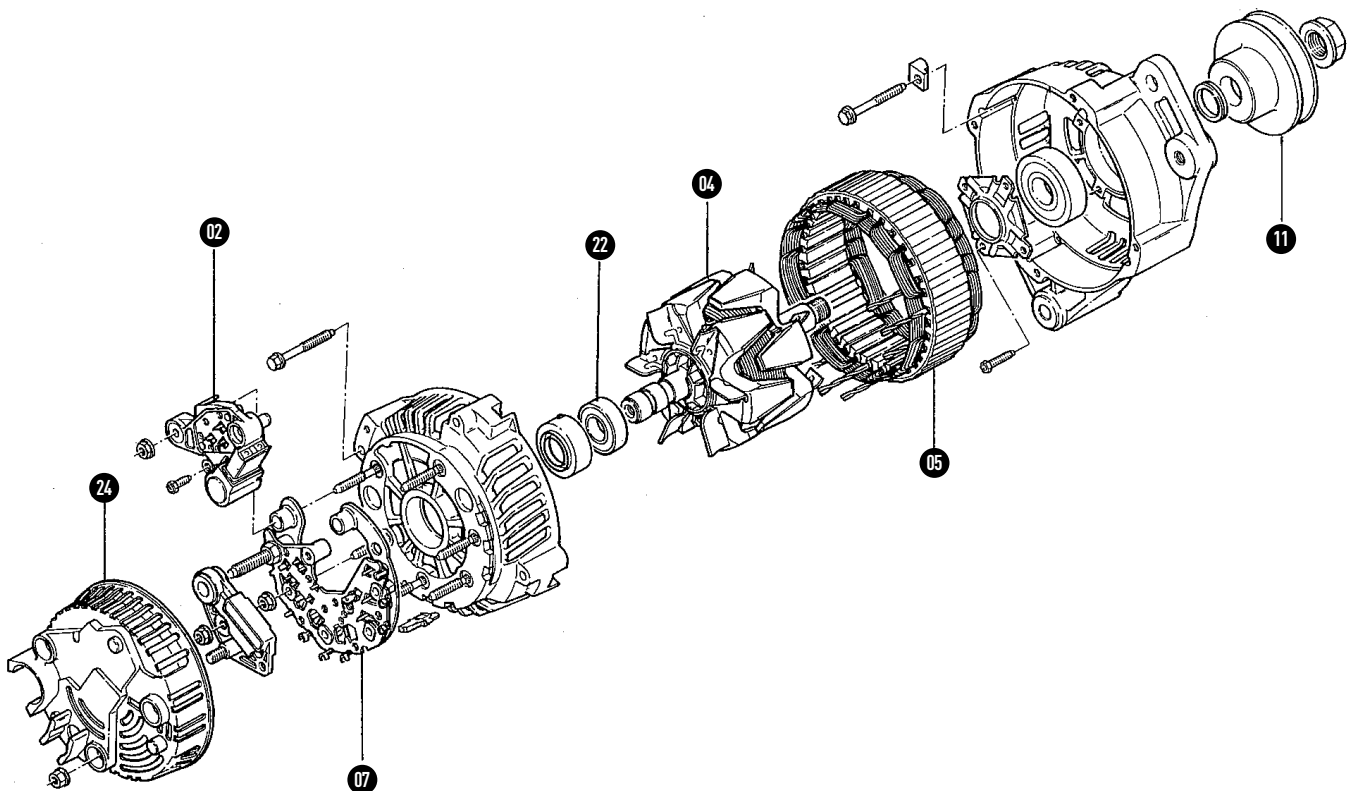









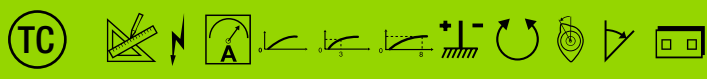

											TC	i	Valeo	02	03	04	05	07
A14N1	5	14	85	1100	72	84		CCW	G	55	12	YV1652	INC	300667			101868	105135
A14N2	5	14	80	1100	66	77		CCW	G	55	12	YV1652	INC	300667				
A14N3T	5	28	65	1500	45	60		CW	D	20	11 / W				300681	101518	101342	
A14N4	5	14	75	1000	61	71		CW	D	20	1 / W	YV1652	INC	590558				
A14N9	5	14	80	950	67	77		CW	G	20	12	YV1652	INC	590558			101025	105135
A14N10	5	14	85	1100	72	84		CW				YV1652	INC	590558			101868	105135
A14N11	5	14	75	1000	65	77		DS				YV2700	INC	300871	599073			105754
A14N12	5	14	75	1200	61	72		CW	D	20	16	YV1652	INC	590558				
A14N13	5	14	80	950	67	77		CW	GD		16	YV1652	INC	590558			101025	180593
A14N14	5	14	80	950	67	77		CW				YV1652	INC	590558			101025	180593
A14N18	5	14	90	1250	76	92		CW	D	20	12	YV1925	INC	182120			101868	593180
A14N19	5	14	80	950	67	77		CW	G	55	12	YV1652	INC	590558			101025	102817
A14N22	5	14	80	950	67	77		CW	GD		16	YV1652	INC	590558			101025	105135
A14N23	5	14	75	950	67	77		CW	G	20	5	YV1925	INC	182120		300694	101025	105754
A14N28T	5	28	65	1500	45	60		CW	D	20	5 / W				300681	101518		
A14N29M	5	14	75	1050	61	73	⊕	CW	D	20	1 / W						101025	
A14N35	5	14	75	1000	63	75		CW	D	20	1	YV1652	INC	590558				
A14N36	5	14	75	1000	63	76		CW	G	20	1	YV1652	INC	590558				
A14N37	5	14	75	950	67	77		CW	G	55	1	YV1652	INC	590558			101025	102817
A14N38	5	14	90	1000	74	94		CW	G	60		YV2700	INC	300871		300696	101868	105754
A14N39	5	28	55	1450	43	57		DS	GD		1 / W						102589	104269
A14N40	5	14	70									YV1652	INC	590558				
A14N42	5	14	70								12	YV1652	INC	590558				
A14N43M	5	28	60	1500	45	61		CW	D	20	4 / W					592727	101518	102556
A14N44M	5	28	60	1500	45	61		CW	D	20	4 / W					592727	101518	102556
A14N47M	5	28	60	1450	45	61	⊕	CW								592727	101518	593199
A14N50	5	14	75	1100	61	72		CW			1	YV1652	INC	590558		593298		
A14N51	5	14	75	1200	61	72		CW	G	60	1	YV1652	INC	590558				
A14N53	5	14	75	1000	61	72		CW	GD		16	YV1652	INC	590558				
A14N54	5	14	75	1000	61	72		CW	D	60	1 / W	YV1652	INC	590558				
A14N55	5	14	80	1100	66	77		CCW	G	55	1	YV1652	INC	590558				
A14N56	5	14	75	1000	61	71		CW	G	60	1	YV1652	INC	590558				
A14N59	5	14	80	1100	71	80		CW	G	20	1	YV1652	INC	590558				
A14N60	5	14	90	1200	74	92		CW	D	60	1	YV1652	INC	590558				
A14N62	5	14	75	1000	61	71		CW	G		1 / W	YV1652	INC	590558				
A14N63	5	14	90	1200	76	92		CW	D	60	1	YV1652	INC	590558				
A14N64	5	14	75	1000	61	72		CW	G		1	YV1652	INC	590558				
A14N65	5	14	75	1000	61	72		CW	D	60	16	YV1652	INC	590558				
A14N67+	5	14	90	850	72	87		DS			1	YV2700	INC	300871	599072			300903
A14N69	5	14	90	1200	74	92		CW			1	YV1652	INC	590558				
A14N70	5	14	90	1200	76	92		CW	D	60	16	YV1652	INC	590558				
A14N71	5	14	90	1000	74	94		CW	G	60		YV2700	INC	300871			101868	105754
A14N73	5	14	105	1150	82	108		CW	GD		1	YV2605	INC	590660			518688	300903
A14N74	5	14	90	1200	76	92		CW			1	YV1652	INC	590558		300696	101868	
A14N75+	5	14	105	1100	82	108		CW	GD		1	YV2605	INC	590660			518688	300903
A14N76+	5	14	105	1150	82	108		CW	D	60	1	YV2605	INC	590660			518688	300903
A14N77	5	14	90	1200	74	92		CW	G	60	1	YV1652	INC	590558				
A14N81M	5	28	60	1450	47	60		CW	G	20	1 / W	ZV3729H	INC	590536		592727	101518	593199
A14N82	5	14	80	1250	68	80		CW	G	10	5	YV1925	INC	182120				
A14N83	5	14	80	1100	68	81		CW	G	10	1	YV1652	INC	590558				
A14N84	5	14	75	1000	59	69		CW			1	YV1652	INC	590558				
A14N85	5	14	75	1000	61	72		CW			1	YV1652	INC	590558				
A14N86	5	14	75	1200	61	71		CW	D	60	1	YV1652	INC	590558				
A14N88	5	14	80	1200	69	80		CW	G	20	5	YV1925	INC	182120				
A14N89	5	14	75	1200	61	72		CW			1	YV1652	INC	590558				
A14N91	5	14	80	1100	68	81		CCW	G	55	5	YV1925	INC	182120		300696		593180
A14N95+	5	14	105	1150	82	108		CW	D	60	1 / W	YV2605	INC	590660			518688	300903
A14N96	5	14	90	1250	76	92		CW	D	60	1	YV1652	INC	590558		300696	101868	180593
A14N97	5	14	75	1000	64	77		CW	D	20	5	YV1652	INC	590558				
A14N99	5	14	75	1200	61	71		CW	G		1	YV1652	INC	590558				
A14N101	5	14	75	1200	61	73		CW	GD		1	YV1652	INC	590558		300696	101025	
A14N102	5	14	90	1250	76	92		CW	G		1	YV1652	INC	590558		300696	101868	
A14N103	5	14	75	1200	61	72		CW	D	60	1	YV1652	INC	590558				
A14N104+	5	28	75	1350	53	75		DS	G									

TC	08	09	09a	11	11c	12	13	14	21	22	24	25	26	30
A14N1				96879						590568 ▲				590627 ▲
A14N2														
A14N3T		300682		101054							590563 ▲	590663 ●		
A14N4														
A14N9				593253			593225			590613 ▲	590563 ▲			590629 ▲
A14N10				593253		592703	300761			590613 ▲	590563 ▲			590629 ▲
A14N11										590613 ▲				590629 ▲
A14N12														
A14N13				593253		592703				590568 ▲	590563 ▲			590627 ▲
A14N14				593253		592703	300761			590613 ▲	590563 ▲	101113		590629 ▲
A14N18										590613 ▲	590563 ▲			590629 ▲
A14N19						592703				590568 ▲	590563 ▲			590627 ▲
A14N22				593253						590568 ▲	590563 ▲	101113		590627 ▲
A14N23			300821	96879						590613 ▲	590563 ▲	102517		590629 ▲
A14N28T												590663 ●		
A14N29M		92967							592860 ▲	590613 ▲	590563 ▲	590574 ●		590629 ▲
A14N35														
A14N36														
A14N37										590568 ▲	590563 ▲			590627 ▲
A14N38										590613 ▲				590629 ▲
A14N39										590613 ▲	590563 ▲			590629 ▲
A14N40														
A14N42														
A14N43M									592780 ▲	590613 ▲	590563 ▲	590574 ●		590629 ▲
A14N44M				101054					592780 ▲	590613 ▲	590563 ▲	590574 ●		590629 ▲
A14N47M		92967							592780 ▲	590613 ▲	590563 ▲			590629 ▲
A14N50														
A14N51														
A14N53														
A14N54														
A14N55														
A14N56														
A14N59														
A14N60														
A14N62														
A14N63														
A14N64														
A14N65														
A14N67+								105604	592860 ▲	590613 ▲				590629 ▲
A14N69														
A14N70														
A14N71						592703				590613 ▲				590629 ▲
A14N73				593209					592860 ▲	590613 ▲	590566 ▲	593228 ●		590629 ▲
A14N74				96879		592703				590613 ▲	590563 ▲			590629 ▲
A14N75+				96879					592860 ▲	590613 ▲	590566 ▲	593228 ●		590629 ▲
A14N76+				105500						590613 ▲		593228 ●		590629 ▲
A14N77														
A14N81M		92967							592780 ▲	590613 ▲	590563 ▲			590629 ▲
A14N82				593253						590613 ▲	590563 ▲			590629 ▲
A14N83														
A14N84														
A14N85														
A14N86														
A14N88				593253						590613 ▲	590563 ▲			
A14N89														
A14N91				96879										
A14N95+				105760							590566 ▲	593228 ●		590629 ▲
A14N96				105500						590613 ▲				590629 ▲
A14N97														
A14N99														
A14N101										590613 ▲	590563 ▲			590629 ▲
A14N102										590613 ▲	590563 ▲			590629 ▲
A14N103														
A14N104+									592860 ▲	590613 ▲	590566 ▲	590658 ●		590629 ▲

												TC	i	Valeo						
A14N105M	5	28	55	1400	42	55		CW	D	20	/ W							102589	593188	
A14N106	5	14	75	1050	61	72		CW	GD		1	YV1652	INC	590558				101025	180593	
A14N107	5	14	90	1300	76	92		CW	G		1	YV1652	INC	590558						
A14N110M	5	28	65	1500	45	61	⊕	CW	D	20	/ W						592727	101518	102556	
A14N112M	5	28	60	1500	45	61	⊕	CW	G	20	/ W	ZV3729H	INC	590536			592727	101518	593199	
A14N113	5	14	75	1000	61	71		CW	D	60	16	YV1652	INC	590558				101025		
A14N114T	5	28	65	1500	45	61	⊕	CW	D	20	/ W						300681	101518	102556	
A14N115M	5	28	60	1500	44	61	⊕	CCW	D	20	/ W						592727	101518	102556	
A14N116M	5	28	60	1500	45	61	⊕	CW	D	20	/ W						592727	101518	102556	
A14N117	5	14	90	1250	76	92		CW	D	60	1	YV1652	INC	590558					105135	
A14N118M	5	28	60	1500	45	61	⊕	CW	G	20	/ W	ZV3729H	INC	590536			592727	101518	593309	
A14N119M	5	28	60	1500	45	61	⊕	CW	G	20	/ W						592727	101518	593199	
A14N120	5	14	100	1200	75	94		CCW	G	55	1						300696			
A14N121	5	14	75	1000	61	71		CW	G	60	1	YV1652	INC	590558						
A14N122M	5	28	60	1500	46	61	⊕	CW	G	20	/ W	ZV3729H	INC	590536			592727	101518	593199	
A14N123	5	14	80	1250	69	80		CW	G	60	5	YV1925	INC	182120						
A14N124+	5	14	105	1100	82	108		CW	D	60	1	YV2605	INC	590660				518688	300903	
A14N125	5	14	90	1200	76	92		CW	D	60	1	YV1652	INC	590558			300696	101868	180593	
A14N130	5	14	90	1250	76	92		CW	G	6	1	YV1652	INC	590558				101868		
A14N131	5	14	90	1250	76	92		CW	D	20	1	YV1652	INC	590558				101868		
A14N132	5	14	90	1350	76	92		CW			1	YV1652	INC	590558			300696	101868	592880	
A14N133	5	28	55	1500	45	57		CW	GD		/ W							102589	104269	
A14N134	5	14	75	1050	61	78		CW	GD		1	YV1652	INC	590558			300696	101025		
A14N135	5	28	55	1500	43	57		DS	GD		/ W							102589	104269	
A14N137M	5	28	60	1500	45	61	⊕	CW	G	2	/ W	ZV3729H	INC	590536			592727	101518	593199	
A14N138+	5	28	75	1350	52	73		DS	GD		/ W								592752	
A14N139	5	14	80	1100	70	82		CW	D	20		YV1926T	INC	590688					592878	
A14N140+	5	14	105	1150	82	107		CW	GD		1	YV2605	INC	590660				518688	300903	
A14N141M	5	28	60	1500	45	61	⊕	CW	G	20	/ W						592727	101518	592754	
A14N142	5	14	90	1200	76	92		CW	GD		1	YV1652	INC	590558			300696	101868		
A14N144	5	14	75	1000	61	71		CW	D	20	1 / W	YV1652	INC	590558			300694	101025	593193	
A14N145	5	14	80	1250	69	80		CW	G	50	5 / W	YV1925	INC	182120						
A14N148	5	14	90	1200	76	92		CW	D	20	2							101025	593199	
A14N150	5	14	75	1000	61	72		CW	GD		1	YV1652	INC	590558			300696	101025		
A14N151	5	14	90	1200	76	92		CW	D	20	1	YV1652	INC	590558				101868		
A14N152	5	14	90	1200	76	92		CW	G	60	1 / W	YV1652	INC	590558			592815	101868	592880	
A14N156	5	14	90	1200	76	92		CW	D	20	1	YV1652	INC	590558				101868		
A14N158	5	14	90	1200	76	92		CW	D	60	1 / W	YV1652	INC	590558				101868	592880	
A14N160+	5	28	75	1350	52	73		DS	GD		/ W								592752	
A14N163	5	14	75	1000	61	71		CW	D	20	1 / W	YV1652	INC	590558			300694	101025	593193	
A14N164	5	14	90	1200	76	92		CW	GD		1 / W	YV1652	INC	590558			300696	101868	592880	
A14N165+	5	14	135	1300	96	133		CW	D	60	1	YV2605	INC	590660					300903	
A14N171	5	14	90	1200	76	92		CW	GD		1	YV1652	INC	590558			300696	101868		
A14N172	5	14	80	1100	60	80		CW	D	20		YV1926T	INC	590688					592878	
A14N173	5	14	80	1100	60	80		CW	G	60	5	YV1925	INC	182120					592877	
A14N176	5	14	90	1200	76	92		CW	D	20	1	YV1652	INC	590558			300694	101868	592880	
A14N177M	5	28	60	1500	44	61	⊕	CCW	D	20	/ W						592727	101518	102556	
A14N178	5	14	90	1200	76	92		CW	GD		1 / W	YV1652	INC	590558			300696	101868	592881	
A14N180+	5	14	105	1150	82	108		CW			5 / W	YV2925	INC	590538				518688	592752	
A14N181	5	14	80	1100	60	80		CW	G	60	5	YV1925	INC	182120					592877	
A14N182	5	28	55	1400	45	56		CW	G	20	/ W							593277	593181	
A14N183M	5	28	60	1500	45	61	⊕	CW	GD		/ W						592727	101518	592882	
A14N185	5	28	55	1400	45	56		CW	G	20	/ W							593277	593181	
A14N190	5	28	55	1400	45	56		CW	G	20	/ W							593277	593181	
A14N194	5	14	80	1100	69	81		CW	G	60	11	YV1925	INC	182120					592877	
A14N195	5	14	80	1100	69	81		CW	G	60	5	YV1925	INC	182120					592877	
A14N196M	5	28	60	1500	44	61	⊕	CW	D	20	/ W						592727	101518	593188	
A14N198M	5	28	60	1500	45	61	⊕	CCW	D	20	/ W						592727	101518	593188	
A14N199	5	14	90	1200	75	92		CW	D	20	16 / W	YV1652	INC	590558			300694	101868	593190	
A14N200M	5	28	60	1500	45	61	⊕	CW	G	20	/ W	ZV3729H	INC	590536			592727	101518	592754	
A14N205+	5	28	75	1300	53	75		CW	GD		/ W								592752	
A14N206M	5	28	60	1500	45	61	⊕	CW	G	20	/ W						592727	101518	593309	
A14N207M	5	28	60	1500	45	61	⊕	CW	G		/ W	ZV3729H	INC	590536			592727	101518	592882	
A14N208M	5	28	60	1500	45	61	⊕	CW	GD		/ W						592727	101518	592882	

TC	08	09	09a	11	11c	12	13	14	21	22	24	25	26	30
A14N105M		92967				592703			592780 ▲	590613 ▲	590563 ▲	590574 ●	590629 ▲	
A14N106				96882						590613 ▲	590563 ▲		590629 ▲	
A14N107														
A14N110M		92967							592860 ▲	590613 ▲	590563 ▲	590574 ●		
A14N112M		92967							592780 ▲	590613 ▲	590563 ▲		590629 ▲	
A14N113			300821	105760						590613 ▲	590563 ▲		590629 ▲	
A14N114T									592860 ▲		590563 ▲	590663 ●		
A14N115M		92967				592703			592860 ▲	590613 ▲	590563 ▲	590574 ●	590629 ▲	
A14N116M		92967							592780 ▲	590613 ▲	590563 ▲	590574 ●	590629 ▲	
A14N117				105760		592703				590613 ▲			590629 ▲	
A14N118M		92967							592780 ▲	590613 ▲	590563 ▲		590629 ▲	
A14N119M		92967							592780 ▲	590613 ▲	590563 ▲		590629 ▲	
A14N120										590613 ▲			590629 ▲	
A14N121														
A14N122M		92967							592780 ▲	590613 ▲	590563 ▲		590629 ▲	
A14N123										590613 ▲	590563 ▲		590629 ▲	
A14N124+										590613 ▲		593228 ●	590629 ▲	
A14N125										590613 ▲			590629 ▲	
A14N130				593253						590613 ▲	590563 ▲			
A14N131				593212						590613 ▲	590563 ▲		590629 ▲	
A14N132				105760						590613 ▲	590563 ▲		590629 ▲	
A14N133										590613 ▲	590563 ▲		590629 ▲	
A14N134				96879						590613 ▲	590563 ▲		590629 ▲	
A14N135										590613 ▲	590563 ▲	590638 ●	590629 ▲	
A14N137M		92967							592780 ▲	590613 ▲	590563 ▲	590663 ●	590629 ▲	
A14N138+								105604	592860 ▲	590613 ▲	590566 ▲	590658 ●	590629 ▲	
A14N139				181485		592703				590613 ▲				
A14N140+				96879		592703			592860 ▲	590613 ▲	590566 ▲			
A14N141M		92967							592780 ▲	590613 ▲	590563 ▲		590629 ▲	
A14N142				96879		592703				590613 ▲	590563 ▲		590629 ▲	
A14N144				101932						590613 ▲	590563 ▲		590629 ▲	
A14N145										590613 ▲	590563 ▲		590629 ▲	
A14N148									592780 ▲	590613 ▲	590563 ▲		590629 ▲	
A14N150				96879						590613 ▲	590563 ▲		590629 ▲	
A14N151				593212		592703				590613 ▲	590563 ▲		590629 ▲	
A14N152				105760		592703				590613 ▲	590563 ▲		590629 ▲	
A14N156						592703				590613 ▲	590563 ▲		590629 ▲	
A14N158				593253		592703				590613 ▲	590563 ▲		590629 ▲	
A14N160+								105604	592860 ▲	590613 ▲	590566 ▲	590658 ●	590629 ▲	
A14N163				101932						590613 ▲	590563 ▲		590629 ▲	
A14N164				105760		592703				590613 ▲	590563 ▲		590629 ▲	
A14N165+						592703				590613 ▲		593228 ●	590629 ▲	
A14N171						592703				590613 ▲	590563 ▲		590629 ▲	
A14N172				181485		592703				590613 ▲				
A14N173										590613 ▲	590563 ▲		590629 ▲	
A14N176				101932		592703				590613 ▲	590563 ▲		590627 ▲	
A14N177M									592860 ▲	590613 ▲	590563 ▲	590574 ●	590629 ▲	
A14N178				96882		592703				590613 ▲	590563 ▲		590629 ▲	
A14N180+						592703		105604		590613 ▲	590566 ▲	593228 ●	590629 ▲	
A14N181				592760						590613 ▲	590563 ▲		590629 ▲	
A14N182						592703				590613 ▲	590563 ▲		590629 ▲	
A14N183M						592703			592780 ▲	590613 ▲	590563 ▲		590629 ▲	
A14N185				593217		592703				590613 ▲	590563 ▲		590629 ▲	
A14N190				593216		592703				590613 ▲	590563 ▲		590629 ▲	
A14N194										590613 ▲	590563 ▲		590629 ▲	
A14N195				592760						590613 ▲	590563 ▲		590629 ▲	
A14N196M		92967				592703			592860 ▲	590613 ▲	590563 ▲		590629 ▲	
A14N198M									592860 ▲	590613 ▲	590563 ▲		590629 ▲	
A14N199		593243		101932		592703				590613 ▲	590563 ▲		590629 ▲	
A14N200M		92967							592780 ▲	590613 ▲	590563 ▲		590629 ▲	
A14N205+									592860 ▲	590613 ▲	590566 ▲		590629 ▲	
A14N206M		92967							592780 ▲	590613 ▲	590563 ▲		590629 ▲	
A14N207M						592703			592780 ▲	590613 ▲	590563 ▲		590629 ▲	
A14N208M						592703			592780 ▲	590613 ▲	590563 ▲		590629 ▲	

																										
	TC	Info	02	03	04	05	07																			
A14R39T	6	28	50	1400	42	57		CW	D	20																
A14R54T	6	28	55	1250	42	55		CW	D	20	12 / W			92956	97486		103756									
A14R541T	6	28	55	1250	42	55		CW	D	20	12 / W			92956	97486		103756									
A14R542T	6	28	55	1250	42	55		CW	D	20	12 / W			92956	97486		103756									
A14R543T	6	28	55	1250	42	55		CW	D	20	12 / W			92956	97486		103756									
A14R544T	6	28	55	1250	42	55		CW	D	20	12 / W			92956	97486		103756									
A14R545T	6	28	55	1250	42	55		CW	D	20	12 / W			92956	97486		103756									
A14S054	-	14	150					CW	G	48	41	YM3699P1C	INC	593839	593844	593285	593588	593840								
A14S055	-	14	150					CW	D	34	41	YM3699P1C	INC	593839	593844	593285	593588	593840								
A14V01	7	14	95	1150	88	103		CW	G	60		YV9911	INC	592781				592700								
A14V02	7	14	105	1150	88	103		CW	G	60		YV9911	INC	592781				592700								
A14V03	7	14	95	1150	88	103		CW	G	60		YV9911	INC	592781				592700								
A14V04	7	14	95	1200	70	88		CW	G	60		YV9911	INC	592781				592835								
A14V05	7	14	90	1150	75	92		CW	G	60		YV9911	INC	592781				592700								
A14V07	7	14	105	1470	88	105		CW	G	85		YV99	INC	592952												
A14V08	7	14	90	1260	79	94		CW	G	85		YV99	INC	592952												
A14V09	7	14	140	1960	116	140		CW	G	85		YV99	INC	592952												
A14V10	7	14	105	1470	88	105		CW	G	85		YV99	INC	592952												
A14V11	7	14	90	1260	79	94		CW	G	85		YV99	INC	592952												
A14V12	7	14	140	1960	116	139		CW	G	85		YV99	INC	592952												
A14V13	7	14	105	1470	90	107		CW	G	60	1	YV9911	INC	592781				592835								
A14V14	7	14	90	1260	79	94		CW	G	85		YV99	INC	592952												
A14V15	7	14	105	1470	90	105		CW	G	85		YV99	INC	592952												
A14V16	7	14	140	1960	117	142		CW	G	85																
A14V17	7	14	90	1260	75	90		CW	G	95		YV99	INC	592952												
A14V18	7	14	105	1470	90	108		CW	G	90		YV99	INC	592952												
A14V19	7	14	140	1960	115	143		CW	G	95																
A14V20	7	28	80	1400	59	82		CW	G	85																
A14VI10	7	14	120	1000	100	118		CW	D	20		YM6952	INC	593350		593285	593159	593202								
A14VI11	7	14	120	1000	100	118		CW	D	20		YM6952	INC	593350		593285	593159	593202								
A14VI13	7	14	120	1000	100	118		CW	G	60	/ W	YM6952	INC	593350		593285	593159	593202								
A14VI14	7	14	120	1000	100	118		CW	G	60		YM6952	INC	593350		593285	593159	593202								
A14VI15+	8	14	150	1000	128	157		CW	G	60		YM6603	INC	593284		593285	593286	593287								
A14VI16+	8	14	150	1000	128	157		CW	G	60		YM6603	INC	593284		593285	593286	593287								
A14VI17+	8	14	150	1000	128	157		CW	G	40		YM1600	INC	593290		593285	593286									
A14VI18	8	14	120	1000	100	118		CW	G	40		YM1600	INC	593290		593285	593159									
A14VI21	8	14	110					CW	G	60	155	YM2621P2	INC	593342		593285	593159	593449								
A14VI22	8	14	120					CW	G	35	41	YM3618P1C	INC	593347		593285	593159	593348								
A14VI23	8	14	150		75	150		CW	D	60	127	YM2621P2	INC	593342		593285	593286	593345								
A14VI24	8	14	120	1000	100	118		CW	G	40		YM1600	INC	593290		593285	593159									
A14VI25	8	14	150	1000	139	157		CW	G	45		YM1600	INC	593290		593285	593286									
A14VI26	8	14	120					CW	G	90	41	YM3618P1C	INC	593347		593285	593159	593348								
A14VI27+	8	14	150	1000	139	157		CW	G	40		YM6603	INC	593284		593285	593286	593499								
A14VI28	8	14	120					CW	G	35	41	YM3618P1C	INC	593347		593285	593159									
A14VI29+	8	14	150					CW	G	90	41	YM3618P1C	INC	593347		593285	593286	593502								
A14VI30	7	14	120	1000	100	123		CW	D	20		YM6952	INC	593350		593285	593159	593202								
A14VI31	7	14	120	1000	100	123		CW	D	20		YM6952	INC	593350		593285	593159	593202								
A14VI34	8	14	150	1200	128	151		CW	G		30	YM3634VFP2	INC	593406		593285	593286	593345								
A14VI35	8	14	150	1000	139	157		CW	G	40		YM6603	INC	593284		593285	593286	593499								
A14VI36	8	14	150	1200	124	158		CW	G	60	30	RC9101	INC	593362		593798	593286	593460								
A14VI37	8	14	120	1300	111	129		CW	D	20		YM6951	INC	593138		593285	593159	593404								
A14VI39	8	14	110					CW	G	60	155	YM2621P2	INC	593342		593285	593159	593449								
A14VI41	8	14	150	1000	139	157		CW	G	40		YM6603	INC	593284		593285	593286	593499								
A14VI42	8	14	150	1000	139	157		CW	G	40		YM6603	INC	593284		593285	593286	593499								
A14VI45	8	14	150					CW	G	34	30	YM3634VFP2	INC	593406		593285	593286	593502								
A14VI46	8	14	150	1200	128	151		CW	G		30	YM3634VFP2	INC	593406		593285	593286	593502								
A14VI47	8	14	150	1200	128	162		CW	G	34	30	YM3634VFP2	INC	593406		593285	593286	593345								
A14VI48	8	14	150	1000	139	157		CW	G	40	21					593285	593286	593499								
A14VI49	8	14	150	1000	139	157		CW	G	40	22	YM6663PF	INC	593498		593285	593286	593499								
A14VI52	8	14	150					CW	G	34	41	YM3618P1C	INC	593347		593285	593286	593345								
A14VI53	8	14	150	1200	128	162		CW	G	34	41	YM3618P1C	INC	593347		593285	593286	593345								

TC	08	09	09a	11	11c	12	13	14	21	22	24	25	26	30	
A14R39T			101164												
A14R54T	103730														77973
A14R541T	103730			95392				101591							77973
A14R542T	103730			593253				100518							77973
A14R543T	103730							300761							77973
A14R544T								100518							77973
A14R545T															77973
A14S054															
A14S055									593563 ▲	593564 ▲	593841 ▲				
A14V01						592703			593563 ▲	593564 ▲	593841 ▲				
A14V02						592703				590613 ▲					
A14V03						592703				590613 ▲					
A14V04										590613 ▲					
A14V05						592703				590613 ▲					
A14V07						592955									
A14V08						592955									
A14V09						592955									
A14V10						592955									
A14V11						592955									
A14V12						592955									
A14V13												519762			
A14V14						592955									
A14V15						592955									
A14V16						592955									
A14V17						592955									
A14V18						592955									
A14V19						592955									
A14V20						592703									
A14VI10				593758				592853	593674 ▲	593564 ▲	593247 ▲				593282
A14VI11				593758				592853	593674 ▲	593564 ▲					593282
A14VI13				593759				592853	593674 ▲	593564 ▲	593247 ▲				593282
A14VI14								592853	593674 ▲	593564 ▲	593247 ▲				593282
A14VI15+				593748				593288	593674 ▲	593564 ▲	593289 ▲				593282
A14VI16+				593759				593288	593674 ▲	593564 ▲	593289 ▲				593282
A14VI17+				593761					593674 ▲	593564 ▲	593296 ▲				593282
A14VI18				593761					593674 ▲	593564 ▲	593294 ▲				593282
A14VI21				593717					593563 ▲	593564 ▲	593452 ▲				593453
A14VI22									593674 ▲	593564 ▲					593282
A14VI23									593674 ▲	593564 ▲	593346 ▲				593282
A14VI24				593761					593674 ▲	593564 ▲	593294 ▲				593282
A14VI25				593761					593674 ▲	593564 ▲	593296 ▲				593282
A14VI26									593674 ▲	593564 ▲	593352 ▲				593282
A14VI27+				593762				593288	593674 ▲	593564 ▲	593289 ▲				593282
A14VI28									593674 ▲	593564 ▲	593352 ▲				593282
A14VI29+									593674 ▲	593564 ▲	593361 ▲				593282
A14VI30				593731				592853	593674 ▲	593564 ▲	593247 ▲				593282
A14VI31				593759				592853	593674 ▲	593564 ▲	593247 ▲				593282
A14VI34									593674 ▲	593564 ▲	593407 ▲				593282
A14VI35					588015			593288	593674 ▲	593564 ▲	593289 ▲				593282
A14VI36									593674 ▲	593564 ▲	593462 ▲				593282
A14VI37				593736					593674 ▲	593564 ▲	593405 ▲				593282
A14VI39									593563 ▲	593564 ▲	593452 ▲				593453
A14VI41					588015			593288	593674 ▲	593564 ▲	593289 ▲				593282
A14VI42				593620				593288	593674 ▲	593564 ▲	593289 ▲				593282
A14VI45				593770					593674 ▲	593564 ▲	593407 ▲				593282
A14VI46									593674 ▲	593564 ▲	593407 ▲				593282
A14VI47									593674 ▲	593564 ▲	593407 ▲				593282
A14VI48					593907			593501	593563 ▲	593564 ▲					593282
A14VI49					593907			593501	593674 ▲	593564 ▲					593282
A14VI52									593674 ▲	593564 ▲	593361 ▲				593282
A14VI53									593674 ▲	593564 ▲	593361 ▲				593282



**Valeo 593282 / 593453 → A14VI**



1 Assembling Protector (For Brushes Protection)	1 protezione montaggio (protezione spazzole)	1 montaj parçası (kömür koruma için)
1 protecteur de montage (protection des balais)	1 Montage beschermer (voor bescherming van koolborstels)	1 сборочный протектор (для защиты щеток)
1 protector de montaje (protección de la escobillas)	1 Montageschutz (für die Kohlen)	1 protector de montagem (para protecção das escovas)
1 protector de montagem (para protecção das escovas)	1 osłona kpl. (do ochrony szczotek)	



4 Holding Nuts Of The Rectifier Bridge	4 dadi di tenuta	4 diod köprüsü tutucu vidası
4 écrous de maintien du pont redresseur	4 Bevestigingsmoeren van diodebrug	4 гайки диодного моста
4 tuercas de fijación del puente de diodos	4 Gleichrichter- Befestigungsschrauben	4 porcas de fixação da ponte de diodos
4 porcas de fixação da ponte de diodos	4 nakrętki mocujące mostek diodowy	



1 Connecting Screw (Brass)	1 vite di fissaggio (ottone)	1 bağlama vidası (pirinç)
1 vis de liaison (laiton)	1 aansluitcroef (messing)	1 контактный болт (медь)
1 tornillo de unión (latón)	1 Verbindungsschraube (Messing)	1 parafuso de união (latão)
1 parafuso de união (latão)	1 złączeniowy wkręt (miedziany)	



1 340 Rhodorsyl Silicon Paste (Termal Conductivity) (Before Refitting, Coat The Baseplate Of The Rectifier Bridge)	1 tubetto di silicone 340 Rhodorsyl (conduttore termico) (Indurre la base della piastra diodi, prima di rimontarla)	1 tüp 340 Rhodorsyl silikon (ısı iletlen) (tekrar takmadan önce diod köprüsü tabanının kaplamasını yapın)
1 tube de pâte silicone (conducteur thermique) 340 Rhodorsyl (Enduire la semelle du pont redresseur avant remontage)	1 Tube Rhodorsyl siliconen pasta (thermische geleiding) (Voor hermontage, de grondplaat van de diodebrug insmeren)	1 Силиконовая паста Rhodorsyl (теплопроводность) (Перед переустановкой, покройте опорный диск диодного моста)
1 tubo de sílicona (conductor térmico) 340 Rhodorsyl (Dar la pasta a la placa de diodos antes del montaje)	1 Silikonpaste. Den Sockel der Diodenplatte vor der Montage bestreichen	1 tubo de silicone (conductor térmico) 340 Rhodorsyl. Aplicar na placa de diodos antes de montar
1 tubo de silicone (conductor térmico) 340 Rhodorsyl Aplicar na placa de diodos antes de montar	1 tubka silikonu przewodzącego ciepło (340 rhodorosylu) (przed montażem posmarować podstawę mostka diodowego)	



4 Assembly Screws Attaching The Rear Bearing To The Front Bearing	4 viti di fissaggio del supporto posteriore sull' anteriore	4 şrubu mocujące obudowy łożysk
4 vis d'assemblage palier arrière sur palier avant	4 bevestiging schroeven om het voorste lager aan het achterste lager te monteren	4 ön-arka kapak bağlantı vidası
4 tornillos de montaje	4 Befestigungsschrauben Vorderes / hinteres Lagerschild	4 сборных болта, крепящих задний подшипник к переднему
4 parafusos de montagem		4 parafusos de montagem



Sleeve	Manga	Hülle	Рукав
Gaine	Guaina	Tuleja	Manga
Manguito	Huls	Kol	

**Valeo 593282 → A14VI**



1 Rear Bearing Capsule	1 capsula cuscinetti posteriore	1 arka rulman kapsülü
1 capsule de roulement arrière	1 kapje achterste lager	1 капсула заднего подшипника
1 cápsula de rodamiento trasero	1 Lagerkapselung, hinten	1 cápsula de rolamento traseiro
1 cápsula de rolamento traseiro	1 kapsula tylnego łożyska	



Wire shell	Terminal	Kabelschuh	Обмотка проводов
Cosse	Guscio in ferro	Izolacja	Terminal
Terminal stator	Kabelgoot	Kablo Koruyucu	



Stator rectifier sleeve	Manga de soldadura	Hülse	Рукав выпрямителя стартера
Manchon de soudure	Guaina del ponte diodi	Tuleja stojana	Manga de soldadura
Manguito rectificador del estator	Huls gelijkrichter	Stator doğrultucu kolu	

**Valeo 593453 → A14VI**



Plastic capsule	Cápsula de plástico	Kunststoffabdeckung	Пластиковая капсула
Capsule plastique	Capsula in plastica	Plastikowa kapsula	Cápsula de plástico
cápsula de plástico	Kunststof kapje	Plastik kapsül	







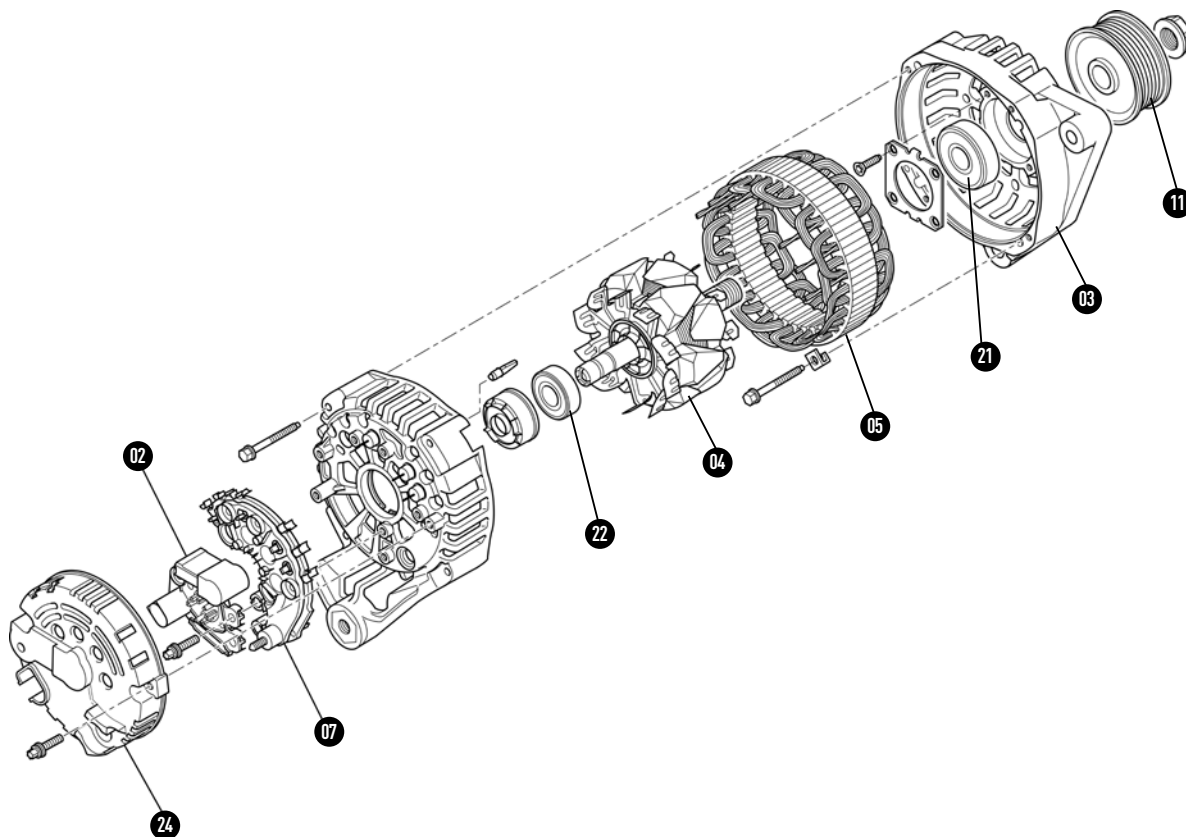



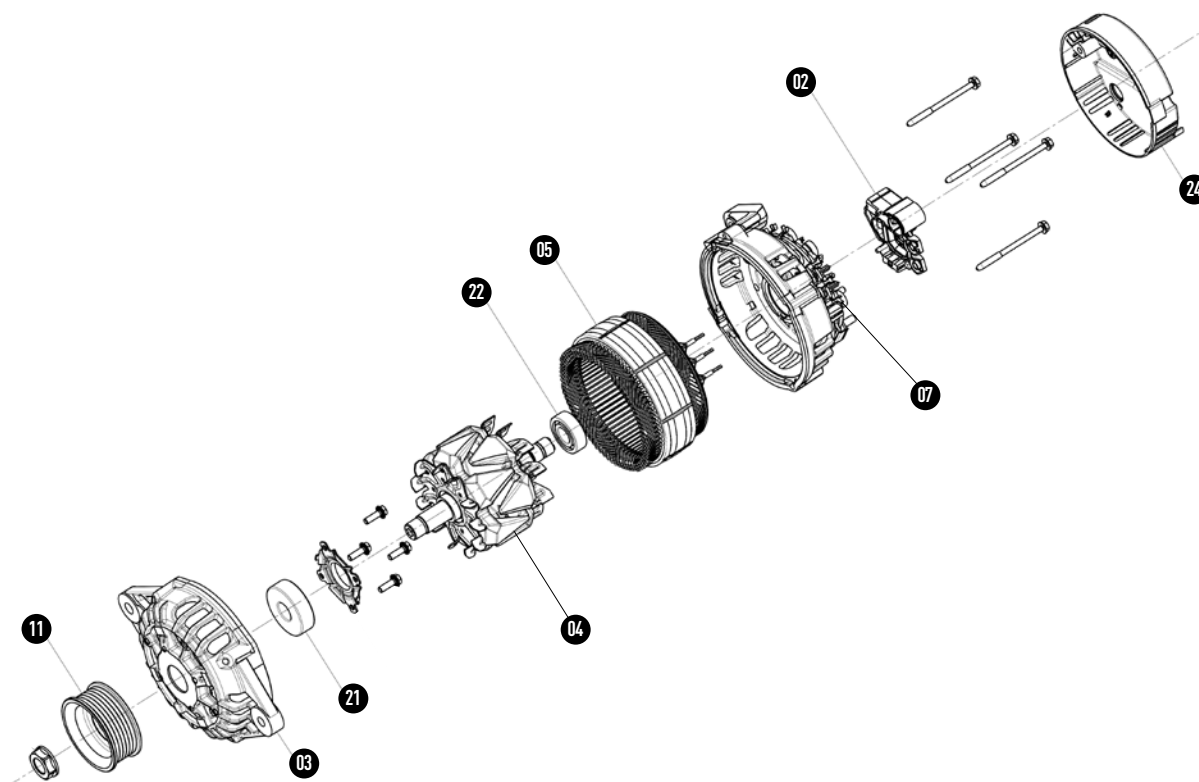



## 9 SG/B













## 10 SG/S



											TC	i	Valeo		
SG7S010	10	14	75	1000	62	72	CW			21	YR CPLE	INC	593939	593635	
SG7S012	10	14	75	1200	62	72	CW	G	6682	21	YR CPLE	INC	593939	593654	
SG7S013	10	14	75	1000	67	78	CW			21	YR CPLE	INC	593939	593635	
SG7S014	10	14	70	1000	60	67	CW	G	40		YR208	INC	593534	593657	
SG7S015	10	14	70	1000	66	77	CW	G	40	22	YR208	INC	593529	593657	
SG7S016	10	14	70	1200	66	77	CW	G	40	27	YR208	INC	593529	593657	
SG7S020	10	14	70	1200	64	78	CW	D	60		YM1669P	INC	593505		
SG7S021	10	14	70	1200	63	78	CW	GD			YM1669P	INC	593505		
SG7S024	10	14	70	1000	66	77	CW	G	40		YR208	INC	593534	593657	
SG7S026	10	14	70	1200	63	76	CW	GD							
SG7S028	10	14	75	1000	67	79	CW	G	6983	21	YR CPLE	INC	593546	593654	
SG7S070	10	14	70	1800	62	79	CW	G	59.870.8	21	YR CPLE	INC	593939	593654	
SG7S071	10	14	70	1800	62	79	CW			21	YR CPLE	INC	593939	593635	
SG7S074	10	14	75	1000	67	79	CW	G	6983	21	YR CPLE	INC	593546	593654	
SG8B010	9	14	70	1150	60	70	CW	G	60	30	YR208	INC	599316		
SG8B011	9	14	70	1200	60	70	CW	D	90	30				593644	
SG8B013	9	14	70	1200	60	70	CW	D	90	30				593644	
SG8B015	9	14	70	1200	60	70	CW	D	90	30				593644	
SG8B016	9	14	70	1200	60	70	CW	D	7588	30				593631	
SG8B017	9	14	70	1200	60	70	CW	D	7588	30				593631	
SG8B018	9	14	70	1200	60	70	CW	D	90	30				593644	
SG8B020	9	14	80	1000	69	80	CW	G	40		YR208	INC	593534	593650	
SG8B021	9	14	80	1000	69	80	CW	G	80	22	YR208	INC	593529	593650	
SG8B022	9	14	80	1000	69	80	CW	G	40	27	YR208	INC	593529	593650	
SG8B023	9	14	70	1200	60	71	CW	D	90	30				593644	
SG8B026	9	14	90	1200	60	71	CW	D	90	30				593644	
SG8B027	9	14	70	1200	60	70	CW	D	90	30	YR208	INC	599316	593644	
SG8B029	9	14	70	1200	60	70	CW	D	90	30	YR208	INC	599316	593644	
SG9B010	9	14	90	1200	82	98	CW	G	30	30	YR208	INC	599316		
SG9B011	9	14	90	1200	82	98	CW	G	60	30	YR208	INC	599316		
SG9B013	9	14	90	1200	76	90	CW	D	90	30				593644	
SG9B015	9	14	90	1200	76	90	CW	D	90	30				593644	
SG9B017	9	14	90	1150	82	99	CW	D	90	30				593644	
SG9B018	9	14	90	1200	76	90	CW	D	90	30				593644	
SG9B019	9	14	90	1200	76	90	CW	D	7588	30				593631	
SG9B023	9	14	90	1200	76	90	CW	D	7588	30				593631	
SG9B024	9	14	90	1200	76	90	CW	D	90	30				593644	
SG9B025	9	14	95	1400	84	105	CW	D	66	220	YM1476P	INC	593389		
SG9B027	9	14	90	1200	82	99	CW	G	60	30					
SG9B029	9	14	90				CW	G	90	41	YM36 9RC7176	INC	593423		
SG9B033	9	14	95	1200	82	97	CW	GD		20	YR CPLE	INC	593936	593639	
SG9B035	9	14	95	1400	82	97	CW	G	7083	21	YR CPLE	INC	593936	593641	
SG9B037	9	14	90	1200	76	90	CW								
SG9B038	9	14	90	1200	76	90	CW				YR208	INC	593945		
SG9B039	9	14	90	1200	76	90	CW								
SG9B040	9	14	90				CW			33	YR124	INC	593536	593648	
SG9B042	9	14	90	1200	82	98	CW	D	90	30				593644	
SG9B047	9	14	95				SH	G/D	0				556578		
SG9B047 SP	9	14	95	1200	82	97	CW			21	YR CPLE	INC	593936	593639	
SG9B048	9	14	90	1200	77	91	CW	D	90	30				593644	
SG9B049	9	14	90	1200	76	90	CW	D	90	30				593644	
SG9B050	9	14	90				CW			33	YR124	INC	593536	593648	
SG9B051	9	14	90				SH	D	89				555516		
SG9B052	9	14	90				CW	G	34	33	YR124	INC	593536		
SG9B053	9	14	95	1200	84	97	CW	D	90	22	YR1615PF	INC	593689	593647	
SG9B054	9	14	90	1200	80	97	CW	D	20		YM1658	INC	593434		
SG9B055	9	14	90	1200	76	91	CW	D	90	30				593644	
SG9B056	9	14	90				CW	G	0	57			555516	555480	
SG9B057	9	14	90	1200	77	90	CW	D	90	30				593644	
SG9B059	9	14	90	1200	76	91	CW	D	90	30	YR208	INC	599316	593644	
SG9B063	9	14	80	1000	69	80	CW	G	40	22	YR208	INC	593529	593650	
SG9B064	9	14	80	1000	69	80	CW	G	40	27	YR208	INC	593529	593650	
SG9B066	9	14	90	1000	82	97	CW	G	80	22	YR208	INC	593529	593650	
SG9B067	9	14	90	1000	82	97	CW	G	40	22	YR208	INC	593529	593650	

TC	 04	 05	 06	 07	 09	 11	 11c	 21	 22	 24
SG7S010	593571	593590		593475		593518		593687 ▲	593688 ▲	593476 ▲
SG7S012	593571	593590		593555		593768		593563 ▲	593688 ▲	593476 ▲
SG7S013	593571	593590		593475		593624		593687 ▲	593688 ▲	593476 ▲
SG7S014	593571	593590		593478		593519		593563 ▲	593688 ▲	593479 ▲
SG7S015	593571	593590		593478		593519		593563 ▲	593688 ▲	593545 ▲
SG7S016	593571	593590		593478		593331		593563 ▲	593688 ▲	593545 ▲
SG7S020	593571	593590		593506				593563 ▲	593688 ▲	593507 ▲
SG7S021	593571	593590		593508				593563 ▲	593688 ▲	593507 ▲
SG7S024	593571	593590		593478		593519		593563 ▲	593688 ▲	593479 ▲
SG7S026	593571	593590		593508		96882		593563 ▲	593688 ▲	593507 ▲
SG7S028	593571	593590		593555		593753		593563 ▲	593688 ▲	593476 ▲
SG7S070	593571	593590		593555		593768		593563 ▲	593688 ▲	593476 ▲
SG7S071	593571	593590		595424		593518		593687 ▲	593688 ▲	593476 ▲
SG7S074	593571	593590		593555		593753		593563 ▲	593688 ▲	593476 ▲
SG8B010		593579		593372				593563 ▲	593564 ▲	593373 ▲
SG8B011	593926	593579		593414				593563 ▲	593564 ▲	593848 ▲
SG8B013	593926	593579		593414			588001	593563 ▲	593564 ▲	593848 ▲
SG8B015	593926	593579		593482		599137		593563 ▲	593564 ▲	593848 ▲
SG8B016	593926	593579		593483		599137		593563 ▲	593564 ▲	593848 ▲
SG8B017	593567	593579		593483		592920		593563 ▲	593564 ▲	593848 ▲
SG8B018	593567	593579		593482		592920		593563 ▲	593564 ▲	593848 ▲
SG8B020		593579		593509		593519		593563 ▲	593564 ▲	593510 ▲
SG8B021		593579		593509		593519		593563 ▲	593564 ▲	593531 ▲
SG8B022	593567	593579		593509		593619		593563 ▲	593564 ▲	593531 ▲
SG8B023	593926	593579		593503		593615		593563 ▲	593564 ▲	593858 ▲
SG8B026	593567	593579		593503		593777		593563 ▲	593564 ▲	593858 ▲
SG8B027	593926	593579		593414			588001	593563 ▲	593564 ▲	593848 ▲
SG8B029	593926	593579		593482		599137		593563 ▲	593564 ▲	593848 ▲
SG9B010	593926	593579		593372				593563 ▲	593564 ▲	593834 ▲
SG9B011	593567	593579		593372		593593		593563 ▲	593564 ▲	593834 ▲
SG9B013	593567	593579		593414		599137		593563 ▲	593564 ▲	593848 ▲
SG9B015	593926	593579		593414			588001	593563 ▲	593564 ▲	593848 ▲
SG9B017	593567	593579		593439			588008	593563 ▲	593564 ▲	593834 ▲
SG9B018	593567	593579		593482		599137		593563 ▲	593564 ▲	593848 ▲
SG9B019	593567	593579		593483		599137		593563 ▲	593564 ▲	593848 ▲
SG9B023	593567	593579		593483		592920		593563 ▲	593564 ▲	593848 ▲
SG9B024	593926	593579		593482		592920		593563 ▲	593564 ▲	593848 ▲
SG9B025	593996	593579				593595		593563 ▲	593564 ▲	593388 ▲
SG9B027	593567	593579		593372		593593		593563 ▲	593564 ▲	593834 ▲
SG9B029	593567	593579						593563 ▲	593564 ▲	
SG9B033	593996	593579		593408		593610		593563 ▲	593564 ▲	593837 ▲
SG9B035	593996	593579		593469		593614		593563 ▲	593564 ▲	593837 ▲
SG9B037	593996	593579						593563 ▲	593564 ▲	593875 ▲
SG9B038	593996	593579					588083	593563 ▲	593564 ▲	593875 ▲
SG9B039	593996	593579					588085	593563 ▲	593564 ▲	593875 ▲
SG9B040	593567	593579				593606		593563 ▲	593564 ▲	593471 ▲
SG9B042	593567	593579		593439			588008	593563 ▲	593564 ▲	593834 ▲
SG9B047	555522									
SG9B047 SP	593996	593579		593408				593563 ▲	593564 ▲	593837 ▲
SG9B048	593567	593579		593503		593615		593563 ▲	593564 ▲	593858 ▲
SG9B049	593567	593579		593414		599137		593563 ▲	593564 ▲	593848 ▲
SG9B050	593567	593579					593537	593563 ▲	593564 ▲	593471 ▲
SG9B051	555522									
SG9B052	593567	593579						593563 ▲	593564 ▲	
SG9B053	593996	593579		593548				593563 ▲	593564 ▲	
SG9B054	593567	593579		593671		593608		593674 ▲	593564 ▲	593672 ▲
SG9B055	593926	593579		593541		599137		593563 ▲	593564 ▲	593858 ▲
SG9B056	555522	555631		555503		555493				
SG9B057	593926	593579		593503		593777		593563 ▲	593564 ▲	593858 ▲
SG9B059	593567	593869		593414		599137		593563 ▲	593564 ▲	593848 ▲
SG9B063	593996	593579		593509		593519		593563 ▲	593564 ▲	593531 ▲
SG9B064	593996	593579		593509		593619		593563 ▲	593564 ▲	593531 ▲
SG9B066	593996	593579		593509		593519		593563 ▲	593564 ▲	593531 ▲
SG9B067	593996	593579		593509		593619		593563 ▲	593564 ▲	593531 ▲

											TC	i	Valeo		
SG9B069	9	14	90	1200	76	91	CW	G	7286	30	YR208	INC	599316	593631	
SG9B077	9	14	80	1000	70	82	CW	D	20		YR208	INC	593534	595224	
SG9B078	9	14	90	1200	76	90	CW	D	90	30	YR208	INC	599316	593644	
SG9B079	9	14	90	1200	76	90	CW			33	YR COM	INC	593948	595473	
SG9B082	9	14	90				CW	G	0	57					
SG9B087	9	14	90	1200	76	89	CW	D	90	30	YR208	INC	599316	593644	
SG9B088	9	14	90	1200	77	91	CW	D	90	30	YR208	INC	599316	593644	
SG9B089	9	14	95	1200	84	97	CW	D	90	22	YR1615PF	INC	593689	593647	
SG9B092	9	14	90				CW	G	0	M5 Bolt			555621	555480	
SG9B095	9	14	90	1200	76	90	CW	D	90	30	YR208	INC	599316	593644	
SG9B107	9	14	95	1800	82	97	CW	G	3445	21	YR CPLE	INC	593936	593641	
SG9B108	9	14	100	1200	78	108	CW	D	90	22	YR1615PF	INC	593689	593647	
SG9B121	9	14	90	1200	76	90	CW			33	YR COM	INC	593948	595473	
SG9B133	9	14	90												
SG10B010	9	14	120	1300	98	123	CW	D	35		YR CPLE	INC	593936	593633	
SG10B011	9	14	120	1300	98	126	CW	GD		21	YR CPLE	INC	593936	593776	
SG10B013	9	28	60	1700	50	61	CW	D	20	158 / W	ZV3962	INC	593400		
SG10B014	9	28	60	1700	50	61	CW	D	20	/ W	ZV3962	INC	593400		
SG10B016	9	14	120	1250	96	126	CW			21	YR CPLE	INC	593936	593640	
SG10B017	9	14	100				CW	G	0	M5 Bolt			555517	555481	
SG10B018	9	14	105	900	96	116	CW	D	55	158					
SG10B019	9	14	120	1300	96	126	CW	D	35	21	YR CPLE	INC	593937	593633	
SG10B020 SP	9	14	120	1300	98	126	CW			21	YR CPLE	INC	593936	593640	
SG10B021	9	14	97	1000	95	108	CW	G	40		YR208	INC	593534	593651	
SG10B022	9	14	90	1000	95	109	CW	G	80	22	YR208	INC	593529	593651	
SG10B023	9	14	90	1000	95	109	CW	G	40	22	YR208	INC	593529	593651	
SG10B031	9	14	120	1300	98	126	CW	GD		21	YR CPLE	INC	593936	593776	
SG10B032	9	14	120	1300	98	126	CW	GD		21	YR CPLE	INC	593936	593776	
SG10B034	9	14	100				SH	G/D	0				555621	555481	
SG10B035	9	14	120	1300	98	126	CW	GD		21	YR CPLE	INC	593936	593776	
SG10B048	9	14	97	1000	95	109	CW	G	40	22	YR208	INC	593529		
SG10B079 SP	9	14	120	1300	96	126	CW	G	59	/ W					
SG10S037	10	14	105												
SG10S038	10	14	105												
SG10S39	10														
SG10S042	10	14	105												
SG10S044	10	14	105									INC	702157		
SG10S049	10														
SG10S050	10	14	105												
SG10S051	10	14	100				CW	G/D		154		INC	702157		
SG10S057	10	14	105												
SG11B010	9	14	110				CW			33					
SG12B010	9	14	120	1200	106	122	CW	G	60	30	YR208	INC	599316	593627	
SG12B011	9	14	120	1200	106	122	CW	G	60	30	YR208	INC	599316	593627	
SG12B012	9	14	120	1200	106	124	CW	D	90	30	YR208	INC	599316	593632	
SG12B015	9	14	120	600	120	123	CW	D	90	30				593632	
SG12B016	9	14	120	1200	106	122	CW	G	60	30				593627	
SG12B017	9	14	125	1200	116	130	CW	D	90	22	YR CPLE	INC	593937	593632	
SG12B018	9	14	120	1200	106	122	CW	G	60	30	YR208	INC	599316	593627	
SG12B020	9	28	80	1700	66	82	CW	D	20	/ W	ZV3962	INC	593400		
SG12B021	9	14	120	1300	106	122	CW	D	60	31	YR208	INC	593944		
SG12B022	9	14	120	1300	106	122	CW	D	60	31	YR3630PF	INC	593943		
SG12B023	9	14	120	1200	106	122	CW	D	60	31	YR208	INC	593944		
SG12B024	9	14	120	1300	106	122	CW	D	60	31	YR3630PF	INC	593943		
SG12B025	9	14	120	1200	106	122	CW	G	60	30	YR208	INC	595452	593627	
SG12B027	9	14	120	1300	106	122	CW	D	60	31	YR208	INC	593944		
SG12B028	9	14	120	1300	106	122	CW	D	60	31	YR3630PF	INC	593943		
SG12B029	9	14	120				CW	G	95	41	YM36 9RC7176	INC	593423	593645	
SG12B030	9	14	125	1200	116	130	CW	D	90	21	YR CPLE	INC	593937	593632	
SG12B038 SP	9	14	120	1200	116	130	CW	D	90	21	YR CPLE	INC	593937	593632	
SG12B039	9	14	120	1500	108	126	CW	G	95	41	YM36 9RC7176	INC	593423	593645	
SG12B040	9	14	120	1200	110	128	CW	D	20		YM1658	INC	593434	593652	
SG12B041	9	14	125	950	110	130	CW	D	35	158					
SG12B042	9	14	120	1250	120	123	CW	D	90	30				593632	











TC										
SG9B069	593926	593869		593483		593868		593563 ▲	593564 ▲	593848 ▲
SG9B077	593996	593952		595221		595222		593563 ▲	593564 ▲	595223 ▲
SG9B078	593567	593579		593414			588001	593563 ▲	593564 ▲	593848 ▲
SG9B079	593567	593952		593949		593950		593563 ▲	593564 ▲	593951 ▲
SG9B082		555631								
SG9B087	593926	593579		593414		599137		593563 ▲	593564 ▲	593848 ▲
SG9B088	593926	593869		593414		599137		593563 ▲	593564 ▲	593848 ▲
SG9B089	593567	593579		595225				593563 ▲	593564 ▲	
SG9B092		555631		555503		555493				
SG9B095	593926	593579		593482				593563 ▲	593564 ▲	593848 ▲
SG9B107	593996	593579		593408		593614		593563 ▲	593564 ▲	593837 ▲
SG9B108		593579		595225				593563 ▲	593564 ▲	
SG9B121	599268	593952		593949		593950		593563 ▲	593564 ▲	593951 ▲
SG9B133					501400					
SG10B010	593800	593801		593397				593563 ▲	593564 ▲	593837 ▲
SG10B011	593800	593801		593399				593563 ▲	593564 ▲	593837 ▲
SG10B013								593563 ▲	593564 ▲	
SG10B014										
SG10B016	593325	593583		593418		593610		593563 ▲	593564 ▲	593837 ▲
SG10B017	555520	555476		555505		555494				
SG10B018	593147	593586						593563 ▲	593564 ▲	
SG10B019	593800	593801		593397			593515	593563 ▲	593564 ▲	593680 ▲
SG10B020 SP	593325	593583		593418				593563 ▲	593564 ▲	593837 ▲
SG10B021	593147	593586		593530		593519		593563 ▲	593564 ▲	593510 ▲
SG10B022	593147	593586		593530		593519		593563 ▲	593564 ▲	593531 ▲
SG10B023	593147	593586		593530		593619		593563 ▲	593564 ▲	593531 ▲
SG10B031	593800	593801		593399				593563 ▲	593564 ▲	593837 ▲
SG10B032	593800	593801		593399			588010	593563 ▲	593564 ▲	593837 ▲
SG10B034	555520	555476		555506						
SG10B035	593800	593801		593399				593563 ▲	593564 ▲	593837 ▲
SG10B048	593147	593586		593530			593832	593563 ▲	593564 ▲	593531 ▲
SG10B079 SP						702059*				
SG10S037										
SG10S038	702206									
SG10S39		702255		702110						
SG10S042	702206									
SG10S044	702206					702058				702009
SG10S049	702206	702255		702110		702060				
SG10S050	702206									
SG10S051	702206	702255		702110		702060				702009
SG10S057	702206					702059				
SG11B010	593147						588055	593563 ▲	593564 ▲	593471 ▲
SG12B010	593570	593580		593542			588008	593563 ▲	593564 ▲	593834 ▲
SG12B011	593570	593580		593542		593593		593563 ▲	593564 ▲	593834 ▲
SG12B012	593570	593580		593547			588008	593563 ▲	593564 ▲	593834 ▲
SG12B015	593570	593580		593415			588001	593563 ▲	593564 ▲	593417 ▲
SG12B016	593570	593580		593542		593594		593563 ▲	593564 ▲	593834 ▲
SG12B017	593568	593580		593830			588010	593563 ▲	593564 ▲	593680 ▲
SG12B018	593570	593580		593542				593563 ▲	593564 ▲	593834 ▲
SG12B020										
SG12B021	593570	593580		593393		593596		593563 ▲	593564 ▲	593553 ▲
SG12B022	593570	593580		593393		593596		593563 ▲	593564 ▲	593553 ▲
SG12B023	593570	593580		593393				593563 ▲	593564 ▲	593553 ▲
SG12B024	593570	593580		593393				593563 ▲	593564 ▲	593553 ▲
SG12B025	593570	593580		593542		593593		593563 ▲	593564 ▲	593834 ▲
SG12B027	593570	593580		593393		593598		593563 ▲	593564 ▲	593553 ▲
SG12B028	593570	593580		593393		593598		593563 ▲	593564 ▲	593553 ▲
SG12B029	593568	593580		593464				593563 ▲	593564 ▲	
SG12B030	593569	593580		593830				593563 ▲	593564 ▲	593680 ▲
SG12B038 SP	593569	593580		593830				593563 ▲	593564 ▲	593680 ▲
SG12B039	593570	593580		593464		593601		593563 ▲	593564 ▲	593425 ▲
SG12B040	593570	593580		593447		593608		593674 ▲	593564 ▲	
SG12B041		593580						593563 ▲	593564 ▲	
SG12B042	593570	593580		593415		593603		593563 ▲	593564 ▲	593417 ▲

▲ = (x10)

\* 599310 599311 599312 599312 599314 599315











⊙	2	6	8	10	12	12
∅	80	61	61	54	48	54

											TC	i	Valeo		
SG12B044	9	14	120				CW			33					593649
SG12B045	9	28	80	1700	66	82	CW	D	20		/ W	ZV3962	INC	593400	
SG12B047	9	14	120	1200	106	122	CW			30					
SG12B049	9	14	120	1200	106	122	CW	D	90	30	YR208	INC	599316		
SG12B050	9	14	120	1200	112	129	CW	D	90	21	YR CPLE	INC	593937	593632	
SG12B052	9	14	125	1200	112	130	CW	D	90	22	YR1615PF	INC	593689	593632	
SG12B054	9	14	120	1200	106	122	CW	D	60	30					593627
SG12B055	9	14	125	1200	110	130	CW	D	90	30	YR1615PF	INC	593689	593632	
SG12B060	9	14	120	1200	106	122	CW	GD		31	YR208	INC	593944		
SG12B062	9	14	120	1200	106	123	CW			32	YR124 COM	INC	593873		
SG12B063	9	14	120	1200	106	124	CW	D	60		YM16106P	INC	593550		
SG12B065	9	14	120				CW			33	YR124	INC	595336	593649	
SG12B068	9	14	125	1200	116	130	CW	D	90	21					593632
SG12B071	9	14	120	1200	112	129	CW	D	90	22	YR1615PF	INC	593689	593632	
SG12B072	9	14	125	1200	112	130	CW	D	90	21	YR1615PF	INC	593689	593632	
SG12B074	9	14	120	1200	106	122	CW	G	60	30					593627
SG12B075	9	14	120	1250	106	122	CW			30					
SG12B080	9	14	120				CW	G	35	41	YM369RC7176	INC	593846	593645	
SG12B081	9	14	125	1200	112	129	CW	D	90	22	YR1615PF	INC	593689	593632	
SG12B082	9	14	120	1200	108	120	CW	D	60		YM16106P	INC	593550		
SG12B087	9	14	120	1200	106	122	CW				YR3647P	INC	593966		
SG12B089	9	14	125	1200	112	129	CW	D	90	21	YR CPLE	INC	593546	593632	
SG12B090	9	14	120	600	120	123	CW	D	90	30	YR208	INC	599316	593632	
SG12B092	9	14	120	1200	110	135	CW	D	90	240	YR124	INC	595252	593632	
SG12B095	9	14	125	1200	112	129	CW	D	90	21	YR CPLE	INC	593546	593632	
SG12B096	9	14	125	1200	112	129	CW	D	90	22	YR1615PF	INC	593689	593632	
SG12B097	9	14	125	1200	119	130	CW	D	90	21	YR1615PF	INC	593689	593632	
SG12B098	9	14	125	1200	112	129	CW	D	90	22	YR1615PF	INC	593689	593632	
SG12B103	9	14	120	1200	102	127	CW	D	90	22	YR1615PF	INC	593689	593632	
SG12B105	9	14	120	1600	110	135	CW	D	90	19	YR1615PF	INC	593689	593632	
SG12B107	9	14	125	1200	119	130	CW	D	90	21	YR1615PF	INC	593689	593632	
SG12B108	9	14	120	1200	110	135	CW	D	90	21	YR CPLE	INC	593546	593632	
SG12B109	9	14	120	1200	110	135	CW	D	90	22	YR1615PF	INC	593689	593632	
SG12B110	9	14	120	1200	110	135	CW	D	90	22	YR1615PF	INC	593689	593632	
SG12B116	9	14	120	1800	110	135	CW	D	90	26	YR CPLE	INC	593546	593632	
SG12B122	9	14	120	1600	110	135	CW	D	90	19	YR1615PF	INC	593689	593632	
SG12B123	9	14	120	1600	110	135	CW	D	90	22	YR1615PF	INC	593689	593632	
SG12B124	9	14	120	1600	110	135	CW	D	90	240					593632
SG12B127	9	14	120	600	120	127	CW	D	90	106	YR124	INC	595450		
SG12S019	9	14	120	800	100	123	CW	G	40		YM1658	INC	593434	593636	
SG12S057	10	14	125												
SG12S071	10	14	125												
SG12S073	10	14	120				CW			30					593656
SG12S074	10	14	125												
SG12S075	10	14	125												
SG12S076	10	14	0				0	0	0					555621	
SG12S083	10	14	125												
SG12S084	10	14	125									INC		702157	
SG12S104	10	14	125												
SG12S120	10	14	125									INC		702157	
SG14B010	9	14	140	1200	126	142	CW			30					
SG14B011	9	14	140	1200	124	142	CW	D	90	30	YR208	INC	599316	593632	
SG14B012	9	14	140	1200	126	142	CW	D	60	30					593627
SG14B013	9	14	140	1200	126	142	CW	G	60	30					593627
SG14B016	9	14	140	1250	122	142	CW			30					
SG14B017	9	14	140				CW			33	YR124 COM	INC	595334	593649	
SG14B019	9	14	140				CW	G	95	41	YM36 9RC7176	INC	593423	593645	
SG14B020	9	14	140				CW	G	95	41					593645
SG14B022	9	14	140	1250	122	142	CW			30	YR208	INC	599316		
SG15L012	-	14	150	1200	140	152	CW			30	YM1689	INC	593779	593867	
SG15L020	-	14	155	1200	141	156	CW	D	90	22	YM1689PF	INC	593666	593867	
SG15L023	-	14	155	1600	141	154	CW	D	90	22	YM1689PF	INC	593666	593867	
SG15L026	-	14	150	1200	140	152	CW			30	YM1689	INC	593779	593867	
SG15L027	-	14	150	1200	141	156	CW	D	90	22	YM1689PF	INC	593666	593867	

TC										
SG12B044	593568	593580		593472		593607		593563 ▲	593564 ▲	593471 ▲
SG12B045										
SG12B047	593570	593580		593979			588032	593563 ▲	593564 ▲	593417 ▲
SG12B049	593570	593580		593547			588008	593563 ▲	593564 ▲	593834 ▲
SG12B050	593570	593580		593830			588038	593563 ▲	593564 ▲	593680 ▲
SG12B052	593569			593830		593836		593563 ▲	593564 ▲	593680 ▲
SG12B054	593570	593580		593542		593593		593563 ▲	593564 ▲	593834 ▲
SG12B055	593570	593580		593830			593517	593563 ▲	593564 ▲	593680 ▲
SG12B060	593570	593580		593393		593605		593563 ▲	593564 ▲	593553 ▲
SG12B062	593570	593580		593393			595258	593563 ▲	593564 ▲	593553 ▲
SG12B063	593570	593580		593393		593621		593563 ▲	593564 ▲	593672 ▲
SG12B065	593568	593580		593472			595203	593563 ▲	593564 ▲	593471 ▲
SG12B068	593569	593580		593830				593563 ▲	593564 ▲	593680 ▲
SG12B071	593570	593580		593830			588010	593563 ▲	593564 ▲	593680 ▲
SG12B072	593569			593830				593563 ▲	593564 ▲	593386 ▲
SG12B074	593570	593580		593542			588008	593563 ▲	593564 ▲	593834 ▲
SG12B075	593570			593393				593563 ▲	593564 ▲	593834 ▲
SG12B080	593570			593464		593755		593563 ▲	593564 ▲	593425 ▲
SG12B081	593569			593830		593836		593563 ▲	593564 ▲	593680 ▲
SG12B082	593568	593580		593393		593621		593563 ▲	593564 ▲	593672 ▲
SG12B087	593570	593580		593393			588039	593563 ▲	593564 ▲	593672 ▲
SG12B089	593570			593830			588004	593563 ▲	593564 ▲	593680 ▲
SG12B090	593570	593580		593415			588001	593563 ▲	593564 ▲	593848 ▲
SG12B092	593570	595248		595247		593836		593563 ▲	593564 ▲	595235 ▲
SG12B095	593570			593830			588038	593563 ▲	593564 ▲	593680 ▲
SG12B096	593570			593830			588010	593563 ▲	593564 ▲	593680 ▲
SG12B097	593569			593830				593563 ▲	593564 ▲	593680 ▲
SG12B098	593569			593830		593836		593563 ▲	593564 ▲	593680 ▲
SG12B103	593568			593830				593563 ▲	593564 ▲	593680 ▲
SG12B105	593570	595248		595247			588004	593563 ▲	593564 ▲	595235 ▲
SG12B107	593570	595248		595247				593563 ▲	593564 ▲	595235 ▲
SG12B108	593570	595248		595247			588038	593563 ▲	593564 ▲	595235 ▲
SG12B109	593570	595248		595247		593836		593563 ▲	593564 ▲	595235 ▲
SG12B110	593570	595248		595247			588010	593563 ▲	593564 ▲	595235 ▲
SG12B116	593570	595248		595247			588038	593563 ▲	593564 ▲	595235 ▲
SG12B122	593570	595248		595247				593563 ▲	593564 ▲	595235 ▲
SG12B123	593570	595248		595247			588010	593563 ▲	593564 ▲	595235 ▲
SG12B124	593570	595248		595247		593836		593563 ▲	593564 ▲	595235 ▲
SG12B127	593570			593415		592920		593563 ▲	593564 ▲	595452 ▲
SG12S019	593570	593580		593435		593613		593563 ▲	593564 ▲	593436 ▲
SG12S057		702257								
SG12S071		702257				702059				
SG12S073	593876	593580		593552		593622		593563 ▲	593564 ▲	593553 ▲
SG12S074		702257				702059				702009
SG12S075		702257								
SG12S076	555629	555479								
SG12S083		702257								
SG12S084		702257				702059				702009
SG12S104		702257								
SG12S120		702257				702059				702009
SG14B010	593569			593979			588032	593563 ▲	593564 ▲	593417 ▲
SG14B011	593569			593547			588008	593563 ▲	593564 ▲	593834 ▲
SG14B012	593569			593542		593593		593563 ▲	593564 ▲	593834 ▲
SG14B013	593569			593542		593593		593563 ▲	593564 ▲	593834 ▲
SG14B016	593569			593393				593563 ▲	593564 ▲	593834 ▲
SG14B017	593570			593472			588036	593563 ▲	593564 ▲	593471 ▲
SG14B019	593569			593464				593563 ▲	593564 ▲	593870
SG14B020	593569			593464				593563 ▲	593564 ▲	593870
SG14B022	593569			593393				593563 ▲	593564 ▲	593834 ▲
SG15L012	593681			593512			588025	593563 ▲	593684 ▲	593513 ▲
SG15L020	593681		595227 <sup>(2)</sup>	593667		593836		593674 ▲	593684 ▲	593669 ▲
SG15L023	593681			593667			595226	593563 ▲	593684 ▲	593669 ▲
SG15L026	593681			593512			588025	593563 ▲	593684 ▲	593513 ▲
SG15L027	593681			593667		593836		593563 ▲	593684 ▲	593669 ▲

TC											02				
											TC		Valeo	03	
SG15L033	-	14	155	1600	141	154	CW	D	90	22	YM1689PF	INC	593666	593867	
SG15L034	-	14	150	1200	141	156	CW	D	90	22	YM1689PF	INC	593666	593867	
SG15L035	-	14	155	1800	141	155	CW	D	90	22	YM1689PF	INC	593666	593867	
SG15L036	-	14	155	1600	141	154	CW	D	90	22	YM1689PF	INC	593666	593867	
SG15S010	10	14	150	1200	130	155	CW	D	20		YM1600	INC	593290	593646	
SG15S016	10	14	150	1000	139	157	CW	G	40		YR208	INC	593532	593658	
SG15S017	10	14	150	1000	139	157	CW	G	40	22	YR208	INC	593773	593658	
SG15S018	10	14	150	1000	139	157	CW	G	79		YR208	INC	593532	593658	
SG15S019	10	14	150	1000	128	152	CW	G	79	50	YR025	INC	599123	593678	
SG15S021	10	14	150	1000	139	157	CW	G	40					593658	
SG15S022	10	14	150	1000	139	157	CW	G	40					593658	
SG15S024	10	14	150	1000	130	152	CW	G	40	21	YR1645VP1	INC	593828	593658	
SG15S025	10	14	150	1000	139	157	CW	G	40	22	YR208	INC	593773	593678	
SG15S030	10	14	150	1000	138	152	CW	G	33	41	YM3699P1C	INC	593839	593844	
SG15S031	10	14	150	1000	139	157	CW	G	40	21	YR208	INC	595354	593678	
SG15S032	10	14	150	1200	130	155	CW	D	20		YM1658	INC	593434	593646	
SG15S037	10	14	150	1000	128	152	CW	G	79		YR025	INC	599123		



TC										
SG15L033	593681		595227 <sup>(2)</sup>	593667			595226	593563 ▲	593684 ▲	593669 ▲
SG15L034	593681		595227 <sup>(2)</sup>	593667		593836		593563 ▲	593684 ▲	593669 ▲
SG15L035	593681			595382		593836		593563 ▲	593684 ▲	593669 ▲
SG15L036	593681			595382			593514	593563 ▲	593684 ▲	593669 ▲
SG15S010	593285	593286		593444		593609		593674 ▲	593564 ▲	
SG15S016	593285	593588		593526		593620		593674 ▲	593564 ▲	593528 ▲
SG15S017	593285	593588		593526		593620		593563 ▲	593564 ▲	599076 ▲
SG15S018	593285	593588		593526			588015	593563 ▲	593564 ▲	593528 ▲
SG15S019	593285	593588		593676			588015	593563 ▲	593564 ▲	593677 ▲
SG15S021	593285	593588		593526		593620		593674 ▲	593564 ▲	593528 ▲
SG15S022	593285	593588		593526			588015	593674 ▲	593564 ▲	593528 ▲
SG15S024	593285	593588		593526			593907	593563 ▲	593564 ▲	599076 ▲
SG15S025	593285	593588		593526			593907	593563 ▲	593564 ▲	599076 ▲
SG15S030	593285	593588		593840				593563 ▲	593564 ▲	593841 ▲
SG15S031	593285	593588		593526		593620		593563 ▲	593564 ▲	599076 ▲
SG15S032	593285	593588		593902		593609		593674 ▲	593564 ▲	593903 ▲
SG15S037										

## 11 TG/B

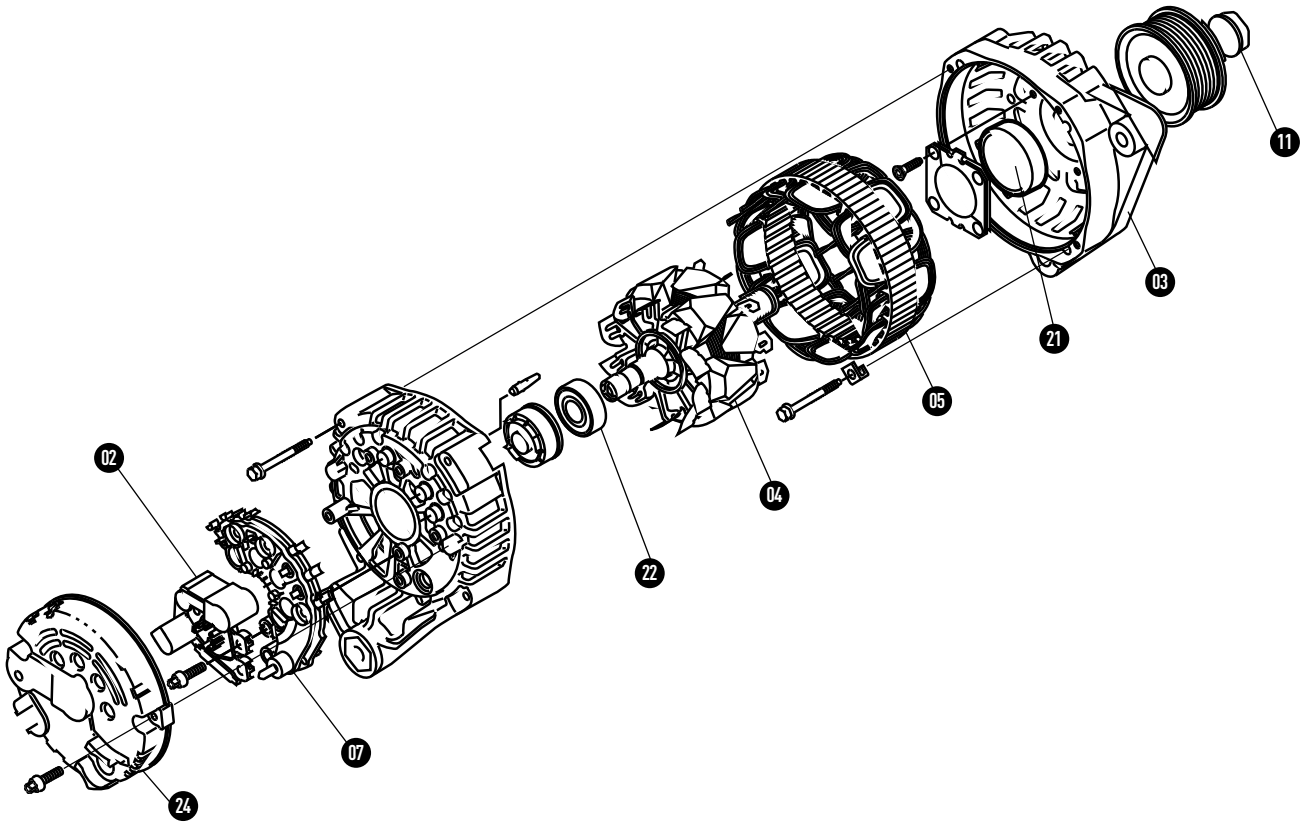



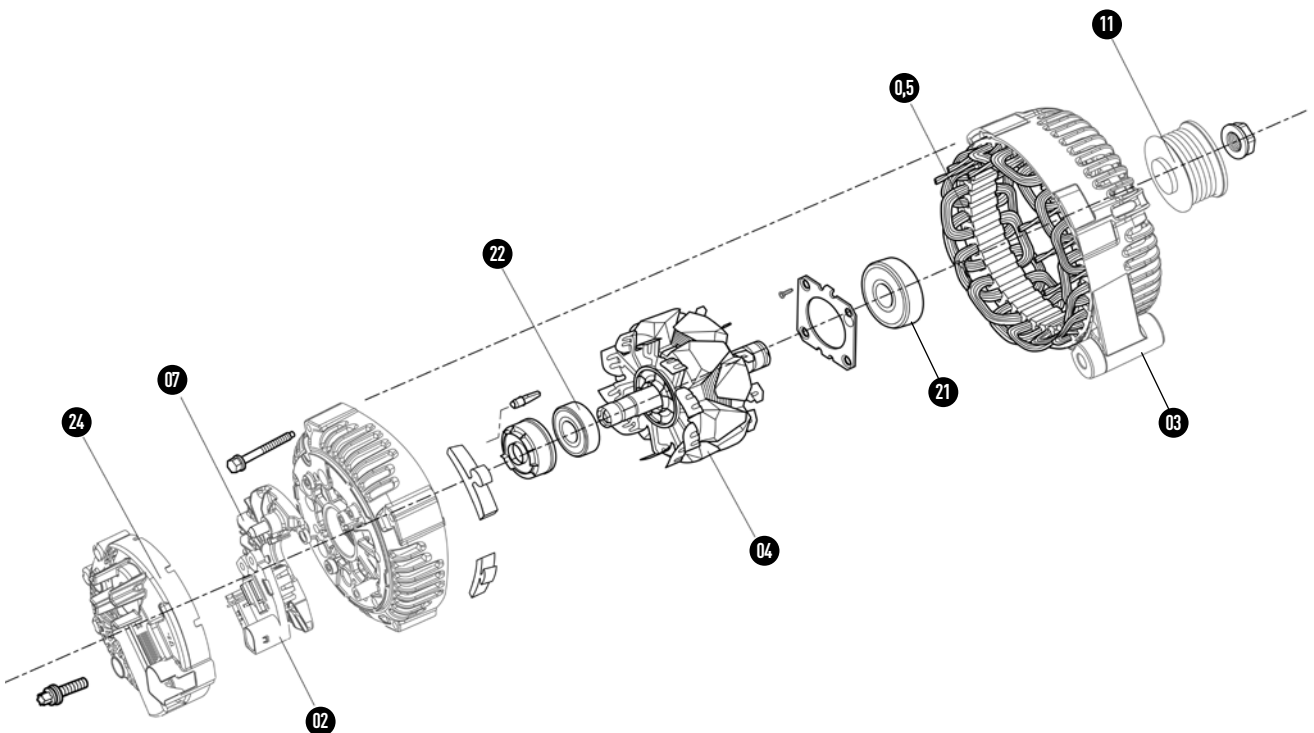



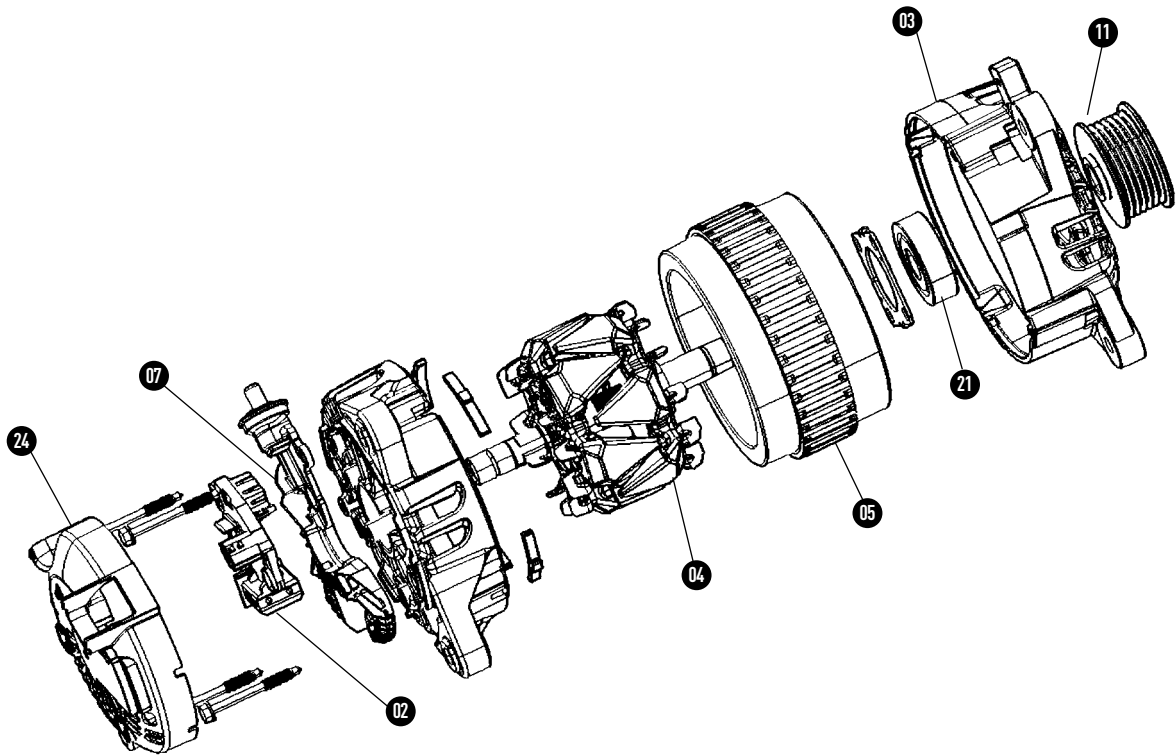

## 12 TG/C











## 13 TG/S



TG7S010	13	14	70	1000	60	70	CW	G	80	22	YR208	INC	593993	593657			
TG7S011	13	14	70	1200	66	77	CW	G	40	27	YR208	INC	593993	593657			
TG7S012	13	14	80	1300	70	90	CW			50	YR025	INC	599121	595250			
TG7S013	13	14	70	1200	60	70	CW	G	80	22	YR208	INC	593993	593657			
TG7S014	13	14	70	1200	60	70	CW	G	79	22	YR208	INC	593993	593657			
TG7S017	13	14	80	1300	70	90	CW			50	YR025	INC	599121	595250			
TG8C011	12	14	80	1200	66	77	CW	G	44	220	YM46104P	INC	593818				
TG8C018	12	14	80	1200	66	77	CW	G	44	21	YR66	INC	593915				
TG8S010	13	14	75	1300	63	77	CW				YR1653P CPLE	INC	593947				
TG8S012	13	14	75	1300	62	77	CW				YR1653P CPLE	INC	593947				
TG8S013	13	14	75	1400	62	77	CW				YR1653P CPLE	INC	593890				
TG8S014	13	14	75	1400	62	77	CW										
TG8S016	13	14	75	1400	62	77	CW				YR1653P CPLE	INC	593890				
TG8S017	13	14	75	1200	62	72	CW	GD		22	YR1615PF	INC	593689	595207			
TG8S019	13	14	80	1200	66	77	CW	G	44	21	YR66	INC	593915	595216			
TG8S021	13	14	75	1300	63	77	CW				YR208	INC	595389				
TG8S022	13	14	75	1300	62	77	CW				YR208	INC	595389				
TG8S023	13	14	75	1400	62	77	CW				YR208	INC	595389				
TG8S024	13	14	80	1200	66	77	CW	G	23	21	YR66	INC	593915	595216			
TG8S025	13	14	80	1800	62	72	CW	GD		22	YR1615PF	INC	593689	595207			
TG8S029	13	14	80											501460			
TG8S030	13	14	80											501460			
TG9B024	11	14	90	1000	84	96	CW	G	80	22	YR208	INC	593993	593650			
TG9B025	11	14	90	1000	82	97	CW	G	40	27	YR208	INC	593993	593650			
TG9B026	11	14	90	1000	84	99	CW	G	40	27	YR208	INC	595354	595209			
TG9B028	11	14	90	1000	84	91	CW	G	40	27	YR208	INC	595354	595209			
TG9B042	11	14	95	1800	80		CW	D	90	240	YR124	INC	595416	595417			
TG9B043	11	14	90	1000	83	97	CW	G	80	22	YR208	INC	593993	593650			
TG9B044	11	14	90	1000	84	96	CW	G	80	22	YR208	INC	595354	595209			
TG9B045	11	14	90	1000	84	96	CW	G	80	22	YR208	INC	595354	595209			
TG9B047	11	14	95	1800	80		CW	D	90	22	YR1615PF	INC	593689	595417			
TG9B049	11	14	90	1500	84	96	CW	G	89	21	YR208	INC	595366	595209			
TG9B052	11	14	95	1800	80		CW	D	90	22	YR1615PF	INC	593689	595417			
TG9B053	11	14	95	1800	80		CW	D	90	22		INC	593689	595417			
TG9B064	11	14	90	1000	84	96	CW	G	80	22	YR208	INC	593993	593650			
TG9B065	11	14	90	1000	84	96	CW	G	78	22	YR208	INC	593993	593650			
TG9B066	11	14	90	1000	84	96	CW	G	80	28	YR208	INC	595354	595209			
TG9B067	11	14	90	1000	84	96	CW	G	78	22	YR208	INC	595354	595209			
TG9B068	11	14	90	1000	84	96	CW	G	78	21	YR208	INC	595366	595209			
TG9B107	11	14	90	1600	80		CW	D	90	60	YR124	INC	595416	595417			
TG9C013	12	14	90	1200	74	92	CW			50	YR025	INC	599121				
TG9C095	12	14	90	1200	74	92	CW			50	YR025	INC	599121				
TG9S010	13	14	90	1300	70	9687	CW				YR1653P CPLE	INC	593947				
TG9S011	13	14	105	1300	89	107	CW				YR1653P CPLE	INC	593890				
TG9S015	13	14	90	1400	70	96	CW				YR1653P CPLE	INC	593890				
TG9S016	13	14	90	1350	62	77	CW										
TG9S021	13	14	90	1400	70	96	CW				YR1653P CPLE	INC	593890				
TG9S022	13	14	90	1400	70	96	CW				YR1653P CPLE	INC	593890				
TG9S027	13	14	115	1250	88	105	CW				YR1653P CPLE	INC	593890				
TG9S036	13	14	90	1300	70	96	CW				YR208	INC	595389				
TG9S037	13	14	90	1300	70	97	CW	GD			YR208	INC	595389				
TG9S038	13	14	90	1400	70	96	CW				YR208	INC	595389				
TG9S039	13	14	105	1300	89	107	CW				YR208	INC	595389				
TG9S040	13	14	115	1800	87	106	CW				YR208	INC	595389				
TG9S060	13	14	105	1750	85	104	CW				YR208	INC	595389				
TG9S063	13	14	90	1400	70	96	CW				YR1653P CPLE	INC	593890				
TG9S100	13	14	105	1500	87	106	CW	GD		33	YR123	INC	599204				
TG9S113	13	14	100											501460			
TG9S114	13	14	100											501460			
TG9S129	13	14	90														
TG10B013	11	14	97	1000	95	109	CW	G	40	22	YR208	INC	595354				
TG10B024	11	14	97	1000	95	109	CW	G	40	22	YR208	INC	595354				
TG10B025	11	14	110	1600	92	115	CW	D	20	60	YR124	INC	595253	595427			
TG10S016	13	14	105														









TC	 04	 05	 07	 11	 11b	 11c	 21	 22	 24
TG7S010	593820	593590	593994	593519			593563 ▲	593564 ▲	599200 ▲
TG7S011	593820	593590	593994	593331			593563 ▲	593564 ▲	599200 ▲
TG7S012	593820	595251	595249				593563 ▲	593564 ▲	599122 ▲
TG7S013	593820	593590	593994	593331			593563 ▲	593564 ▲	599200 ▲
TG7S014	593820	593590	593994	593519			593563 ▲	593564 ▲	599200 ▲
TG7S017	593820	595251	595249				593563 ▲	593564 ▲	599122 ▲
TG8C011	593820						593563 ▲	593564 ▲	
TG8C018	593820						593563 ▲	593564 ▲	593969 ▲
TG8S010	593820	593590	593859	593865			593563 ▲	593564 ▲	593892 ▲
TG8S012	593820	593590	593859			588006	593563 ▲	593564 ▲	593892 ▲
TG8S013	593820	593590	593859			588006	593563 ▲	593564 ▲	593892 ▲
TG8S014						588006			
TG8S016	593820	593590	593859			588006	593563 ▲	593564 ▲	593892 ▲
TG8S017	593820	593590	595205				593563 ▲	593564 ▲	593969 ▲
TG8S019	593820	593590	595215				593563 ▲	593564 ▲	593969 ▲
TG8S021	593820	593590	593859	593865			593563 ▲	593564 ▲	593892 ▲
TG8S022	593820	593590	593859			588006	593563 ▲	593564 ▲	593892 ▲
TG8S023	593820	593590	593859			588006	593563 ▲	593564 ▲	593892 ▲
TG8S024	593820	593590	595215	595257			593563 ▲	593564 ▲	593969 ▲
TG8S025	593820	593590	595381	595415			593563 ▲	593564 ▲	593969 ▲
TG8S029	501580	501610	501550	501520					501430
TG8S030	501580	501610	501550						501430
TG9B024	593926	593952	593995	593519			593563 ▲	593564 ▲	599200 ▲
TG9B025	593996	593952	593995	593619			593674 ▲	593564 ▲	599200 ▲
TG9B026	593996	593952	595208			593832	593563 ▲	593564 ▲	599200 ▲
TG9B028	593996	593952	595208				593563 ▲	593564 ▲	599200 ▲
TG9B042	599268	593952	595418	595419			599266 ▲	593564 ▲	593969 ▲
TG9B043	593926	593952	593995	593619			593563 ▲	593564 ▲	599200 ▲
TG9B044	593926	593952	595208			593832	593563 ▲	593564 ▲	599200 ▲
TG9B045	593926	593952	595208				593563 ▲	593564 ▲	599200 ▲
TG9B047	599268	593952	595418	595217			593563 ▲	593564 ▲	593969 ▲
TG9B049	593926	593952	595208			593832	593563 ▲	593564 ▲	599153 ▲
TG9B052	599268	593952	595418			595407	599266 ▲	593564 ▲	593969 ▲
TG9B053	599295	593952	595418	595217			599266 ▲	593684 ▲	593969 ▲
TG9B064	593926	593952	593995	593519			593563 ▲	593564 ▲	599200 ▲
TG9B065	593926	593952	593995	593619			593563 ▲	593564 ▲	599200 ▲
TG9B066	593926	593952	595208			593832	593563 ▲	593564 ▲	599200 ▲
TG9B067	593926	593952	595208				593563 ▲	593564 ▲	599200 ▲
TG9B068	593926	593952	595208			593832	593563 ▲	593564 ▲	599153 ▲
TG9B107	599268	593952	595418			599267	599266 ▲	593564 ▲	593969 ▲
TG9C013		593864	593808				593563 ▲	593564 ▲	599122 ▲
TG9C095		593864	593808				593563 ▲	593564 ▲	599122 ▲
TG9S010	595390	593864	593859			588006	593563 ▲	593564 ▲	593892 ▲
TG9S011	595390	593927	593859			588006	593563 ▲	593564 ▲	593892 ▲
TG9S015	595390	593864	593859			588006	593563 ▲	593564 ▲	593892 ▲
TG9S016						588006			
TG9S021	595390	593864	593859			588006	593563 ▲	593564 ▲	593892 ▲
TG9S022	595390	593864	593859			588006	593563 ▲	593564 ▲	593892 ▲
TG9S027	595390	593927	593859			599223	593563 ▲	593564 ▲	593892 ▲
TG9S036	595390	593864	593859			588006	593563 ▲	593564 ▲	593892 ▲
TG9S037	595390	593864	593859	593865			593563 ▲	593564 ▲	593892 ▲
TG9S038	595390	593864	593859			588006	593563 ▲	593564 ▲	593892 ▲
TG9S039	595390	593927	593859			588006	593563 ▲	593564 ▲	593892 ▲
TG9S040	595390	593927	593859			599223	593563 ▲	593564 ▲	593892 ▲
TG9S060	595390	599087	593859	593865			593563 ▲	593564 ▲	593892 ▲
TG9S063	595390	593864	593859			588006	593563 ▲	593564 ▲	593892 ▲
TG9S100	595390	593927	593859	593865			593563 ▲	593564 ▲	599198 ▲
TG9S113	501581	501611	501550	501520					501430
TG9S114	501581	501611	501550						501430
TG9S129	501581								
TG10B013	593800	593982	593980			593832	593563 ▲	593564 ▲	599200 ▲
TG10B024	593800	593982	593980			593832	593563 ▲	593564 ▲	599200 ▲
TG10B025		593982	595428	595429			593563 ▲	593564 ▲	595430 ▲
TG10S016	702206								

TG10S017	13	14	105														
TG10S019	13	14	105										INC		702157		
TG10S022	13	14	105														
TG11C010	12	14	110	1200	90	112	CW	D	90	22	YR1615PF	INC	593689	593665 <sup>(1)</sup>			
TG11C011 SP	12	14	110	1200	91	111	CW	D	90	22	YR1615PF	INC	593689	593665 <sup>(1)</sup>			
TG11C014	12	14	110	1500	94	111	CW	D	90	30	YR208	INC	599316	593665 <sup>(1)</sup>			
TG11C015	12	14	110	1500	94	111	CW	D	90	30	YR208	INC	599316	593665 <sup>(1)</sup>			
TG11C016	12	14	110	1400	94	111	CW	D	90	30	YR208	INC	599316	593665 <sup>(1)</sup>			
TG11C017	12	14	110	1400	94	111	CW	D	90	30	YR208	INC	599316	593665 <sup>(1)</sup>			
TG11C022	12	14	110	1200	90	111	CW	D	90	22	YR1615PF	INC	593689	593665 <sup>(1)</sup>			
TG11C024	12	14	110	1000	90	107	CW	D	66	220	9RC7141	INC	593884	593665 <sup>(1)</sup>			
TG11C027	12	14	110	1200	90	111	CW	D	90	22	YR1615PF	INC	593689	593665 <sup>(1)</sup>			
TG11C034	12	14	110	1200	92	111	CW	D	90	22	YR1615PF	INC	593689	593665 <sup>(1)</sup>			
TG11C035	12	14	115	1500	87	107	CW			33	YM	INC	593975	593665 <sup>(1)</sup>			
TG11C036	12	14	115	1200	87	107	CW	G	33	33							
TG11C040	12	14	110	1600	91	111	CW	D	90	240	YR124	INC	595253	593665 <sup>(1)</sup>			
TG11C041	12	14	110	1800	91	111	CW	D	90	240	YR124	INC	595253	593665 <sup>(1)</sup>			
TG11C048	12	14	110	1500	94	111	CW	D	90	30	YR208	INC	599316	593665 <sup>(1)</sup>			
TG11C049	12	14	110	1200	90	111	CW	D	90	22	YR1615PF	INC	593689	593665 <sup>(1)</sup>			
TG11C054	12	14	110	1600	92	115	CW	D	90		YR124	INC	595253	593665 <sup>(1)</sup>			
TG11C055	12	14	110	1600	92	115	CW	D	90	240	YR124	INC	595253	593665 <sup>(1)</sup>			
TG11C056	12	14	115	1800	92	112	CW	D	90	240	YR124	INC	595253				
TG11C057	12	14	110	1500	94	101	CW	D	90	30	YR208	INC	599316	593827 <sup>(1)</sup>			
TG11C059	12	14	115	1200	87	107	CW	G	70	33	YR COM VDA	INC	599304				
TG11C060	12	14	110	1800	92	115	CW	D	90	240	YR124	INC	595253	593665 <sup>(1)</sup>			
TG11C061	12	14	110	1200	90	111	CW	D	90	22	YR1615PF	INC	593689	593665 <sup>(1)</sup>			
TG11C062	12	14	110	1800	92	115	CW	D	90		YR1615PF	INC	593689	593665 <sup>(1)</sup>			
TG11C063	12	14	110	1800	92	115	CW	D	90	22	YR1615PF	INC	593689	593665 <sup>(1)</sup>			
TG11C064	12	14	110	1800	92	115	CW	D	90	22	YR1615PF	INC	593689	593665 <sup>(1)</sup>			
TG11C065	12	14	110	1800	92	115	CW	D	90	240	YR124	INC	595253	593665 <sup>(1)</sup>			
TG11C066	12	14	110	1800	91	111	CW	D	90	240	YR124	INC	595253	593665 <sup>(1)</sup>			
TG11C067	12	14	110	1500	94	111	CW	D	90	30	YR208	INC	599316	593864 <sup>(1)</sup>			
TG11C068	12	14	110	1800	92	115	CW	D	90	240	YR124	INC	595253	593665 <sup>(1)</sup>			
TG11C069	12	14	110	1800	92	115	CW	D	90	240	YR124	INC	595253	593665 <sup>(1)</sup>			
TG11C073	12	14	110	1800	94	111	CW	D	7585	30	YR208	INC	599316	593665 <sup>(1)</sup>			
TG11C074	12	14	115	1500	86	107	CW			33	YM	INC	593975	593665 <sup>(1)</sup>			
TG11C076	12	14	110														
TG11C086	12	14	110	1500	94	101	CW	D	90	30	YR208	INC	599316	593827 <sup>(1)</sup>			
TG11C087	12	14	110	1500	114		CW	G	2								
TG11C089	12	14	110														
TG11C094	12	14	110	1500	94	111	CW	D	90	36							593827 <sup>(1)</sup>
TG11C095	12	14	110	1500	94	111	CW	D	90	36							593827 <sup>(1)</sup>
TG11C096	12	14	110	1500	94	111	CW	D	90	30	YR208	INC	599316	593827 <sup>(1)</sup>			
TG11C131	12	14	110	1500	94	111	CW	D	90	30	YR208	INC	599316	593854 <sup>(1)</sup>			
TG11S010	12																
TG11S011	12																
TG11S050	12																
TG11S051	12	14	115				CW	G/D		154		INC	702157				
TG11S053	12	14	115				CW	D	58	154		INC	702157				
TG11S092	12	14	110				CW	G	45	156		INC	702155				
TG11S102	12	14	110				CW	G	45	156		INC	702155				
TG11S110	12	14	110				CW	G	45	156							
TG12C013	12	14	110	1200	101	117	CW			50	YR025 PCM	INC	593675	593784 <sup>(1)</sup>			
TG12C014	11	14	110				CW	G	45	0		INC	702154				
TG12C015	12	14	120	1200	99	116	CW			50	YR025	INC	599121	593784 <sup>(1)</sup>			
TG12C016	12	14	110	1200	102	115	CW			24	YM66101PF	INC	593845	593784 <sup>(1)</sup>			
TG12C026	12	14	120	1000	95	108	CW			33	YR COM VDA	INC	599304				
TG12C027	11																
TG12C032	11	14	110				CW	G	45	156		INC	702155				
TG12C033	12	14	120	950	100	118	CW	G	55	220	YR CPLE	INC	595283	595285 <sup>(1)</sup>			
TG12C036	12	14	120														
TG12C037	12	14	120	1400	114	121	CW	D	18		YR233	INC	599182	595486 <sup>(1)</sup>			
TG12C038	12	14	120	1250	114	121	CW	G	79	33	YR233	INC	599182	595372 <sup>(1)</sup>			
TG12C039	12	14	120				CW										









TC	 04	 05	 07	 11	 11b	 11c	 21	 22	 24
TG10S017	702206			702057					702006
TG10S019	702206			702058					702008
TG10S022	702206			702057					702006
TG11C010	593800			593836			593563 ▲	593564 ▲	593969 ▲
TG11C011 SP	593800						593563 ▲	593564 ▲	593969 ▲
TG11C014	593800		593883	593868			593563 ▲	593564 ▲	593826 ▲
TG11C015	593800		593824	593825			593563 ▲	593564 ▲	593826 ▲
TG11C016	593800		593852	599137			593563 ▲	593564 ▲	593826 ▲
TG11C017	593800		593852			588001	593563 ▲	593564 ▲	593826 ▲
TG11C022	593800			593836			593563 ▲	593564 ▲	593969 ▲
TG11C024	593888		593885	593886			593563 ▲	593564 ▲	593887 ▲
TG11C027	593800			595217			593563 ▲	593564 ▲	593969 ▲
TG11C034	593800					595407	593563 ▲	593564 ▲	593969 ▲
TG11C035	593800		593976			595386		593564 ▲	593951 ▲
TG11C036	593800		593929				593563 ▲	593564 ▲	593826 ▲
TG11C040	593800			593836			593563 ▲	593564 ▲	593969 ▲
TG11C041	593800					595407	593563 ▲	593564 ▲	593969 ▲
TG11C048	593800		593824			588018	593563 ▲	593564 ▲	593826 ▲
TG11C049	593800			593836			593563 ▲	593564 ▲	593969 ▲
TG11C054	593800						593563 ▲	593564 ▲	593969 ▲
TG11C055	593800			595217			593563 ▲	593564 ▲	593969 ▲
TG11C056			595261						
TG11C057	593800		593824	595356			593563 ▲	593564 ▲	593826 ▲
TG11C059	593800		593929			588025	593563 ▲	593564 ▲	593826 ▲
TG11C060	593800		595362	595217			593563 ▲	593564 ▲	593969 ▲
TG11C061	593800		595362	593836			593563 ▲	593564 ▲	593969 ▲
TG11C062	593800		595362				593563 ▲	593564 ▲	593969 ▲
TG11C063	593800		595362	595217			593563 ▲	593564 ▲	593969 ▲
TG11C064	593800		595362			595407	593563 ▲	593564 ▲	593969 ▲
TG11C065	593800		595362				593563 ▲	593564 ▲	
TG11C066	593800					595407	593563 ▲	593564 ▲	593969 ▲
TG11C067	593147		593852			588016	593563 ▲	593564 ▲	593826 ▲
TG11C068	593800		595362	595409			593563 ▲	593564 ▲	593969 ▲
TG11C069	593800		595362			595407	593563 ▲	593564 ▲	593969 ▲
TG11C073	593147		595435	593868			593563 ▲	593564 ▲	593826 ▲
TG11C074	593800		593976			595386	593563 ▲	593564 ▲	593951 ▲
TG11C076	702206	702258							
TG11C086	593800		593883			588018	593563 ▲	593564 ▲	593826 ▲
TG11C087	702206	702258				599254			
TG11C089	702206	702258							
TG11C094	593800		593883			588018	593563 ▲	593564 ▲	593826 ▲
TG11C095	593800		593824			595440	593563 ▲	593564 ▲	593826 ▲
TG11C096	593800		593883			599327	593563 ▲	593564 ▲	593826 ▲
TG11C131	593147		593852			599248	593563 ▲	593564 ▲	593826 ▲
TG11S010	702206	702258							
TG11S011	702206	702258							
TG11S050	702206	702258		702057					
TG11S051	702206	702250	702117	702058					702008
TG11S053	702206	702250	702116	702057					702008
TG11S092	702203	702250	702102			702062			702007
TG11S102	702203	702250	702102			702062			702007
TG11S110	702203	702250	702102			702062			702007
TG12C013	593800					593782	593563 ▲	593564 ▲	593908
TG12C014	702206	702254	702108	702059					702005
TG12C015	593800					593782	593563 ▲	593564 ▲	599122 ▲
TG12C016	593800					593782	593563 ▲	593564 ▲	
TG12C026	593800		595300			595258	593563 ▲	593564 ▲	595296 ▲
TG12C027		702251	702113	702063					702006
TG12C032	702207	702251	702111			702062			702007
TG12C033	593800		595284			595286	593563 ▲	593564 ▲	595335 ▲
TG12C036		702251				702053			
TG12C037	595413		595321	595487			593563 ▲	593564 ▲	599080 ▲
TG12C038	593800		595374			588002	593563 ▲	593564 ▲	599190 ▲
TG12C039	595413						593563 ▲	593564 ▲	599153 ▲

TG12C040	12	14	125																	
TG12C042	11	14	125				CW	D	53	154										
TG12C043	12	14	120										INC		702156					
TG12C044	12	14	120										INC		702157					
TG12C045	12	14	125										INC		702150					
TG12C048	11	14	125				CW	D	53	154			INC		702156					
TG12C052	12	14	140																	
TG12C053	12	14	140																	
TG12C055	12	14	120																	
TG12C056	12	14	120																	
TG12C057	12	14	130																	
TG12C059	12	14	125	600	100	123	CW			17	YR COM	INC	599149		595320 <sup>(1)</sup>					
TG12C062	12	14	120	1800	104	122	CW	D	90	60	YR124	INC	595411		595412 <sup>(1)</sup>					
TG12C063	12	14	120	1500	92	106	CW			33	YR COM VDA	INC	599304							
TG12C065	12	14	140																	
TG12C066	12	14	120																	
TG12C067	11	14	120				CW	G/D		154										
TG12C069	12	14	140																	
TG12C070	12	14	120																	
TG12C071	12	14	120																	
TG12C072	12	14	120																	
TG12C074	12	14	140																	
TG12C076	12	14	120																	
TG12C077	12	14	120	1800	104	122	CW	D	90	60	YR124	INC	595411		595412 <sup>(1)</sup>					
TG12C078	12	14	120	1800	104	122	CW	D	90	60	YR124	INC	595411		595412 <sup>(1)</sup>					
TG12C079	12	14	120	1680						33										
TG12C084	11	14	125				CW	D	53	154			INC		702156					
TG12C085	12	14	125										INC		702150					
TG12C086	12	14																		
TG12C087	12	14	120	1350	114	120	CW	D	18		YR233	INC	599182							
TG12C090	12	14	120	1000	100	117	CW	G	55	150	YR027	INC	599160							
TG12C091	12	14	120	1800	104	122	CW	D	90	22	YR1615PF	INC	593689		595412 <sup>(1)</sup>					
TG12C092	12	14	120	1500	104	122	CW	D	90	22	YR1615PF	INC	593689		595412 <sup>(1)</sup>					
TG12C094	12	14	120	1500	104	123	CW	D	90	22	YR1615PF	INC	593689		595412 <sup>(1)</sup>					
TG12C098	11	14	120				CW	D	19	33										
TG12C105	12	14	140																	
TG12C106	12	14	120	1000	100	123	CW	G	78	17	YR123	INC	599150		599151 <sup>(1)</sup>					
TG12C107	12	14	120	1300	114	121	CW	D	19	33	YR233	INC	599182							
TG12C108	11	14	120				CW	D	19	33										
TG12C109	12	14	110	1200	101	107	CW	GD		50	YR025 PCM	INC	593675		593784 <sup>(1)</sup>					
TG12C110	12	14	120	1200	99	116	CW			50	YR025	INC	599121		593784 <sup>(1)</sup>					
TG12C113	12	14	110	1500	94	111	CW	D	90	33	YR133 COM VDA	INC	599305		599318					
TG12C116	11	14	110				CW	G	45	156										
TG12C118	12	14	120	1000	100	117	CW	G	55	150	YR027	INC	599160							
TG12C120	12	14	120	1000	100	123	CW	GD		17	YR COM	INC	599149		595320 <sup>(1)</sup>					
TG12C124	12	14	120	1800	104	122	CW	D	90	60	YR143	INC	599260		595412 <sup>(1)</sup>					
TG12C125	12	14	120	1600	104	123	CW	D	90	60	YR143	INC	599260		595412 <sup>(1)</sup>					
TG12C131	12	14	120																	
TG12C138	12	14	120																	
TG12C139	12	14	110	1500	94	111	CW	D	90	33	YR133 COM VDA	INC	599305		599318					
TG12C140	12	14	120	1000	100	117	CW	G	55	143	YR027	INC	599269							
TG12C141	12	14	120	1000	100	117	CW	G	55	150	YR027	INC	599269							
TG12C143	12	14	140																	
TG12C144	12	14	140										INC		702152					
TG12C150	12	14	120	1800	104	122	CW	D	90	60	YR124	INC	595411		595412 <sup>(1)</sup>					
TG12C151	12	14	120	1500	104	123	CW	D	90	22	YR1615PF	INC	593689		595412 <sup>(1)</sup>					
TG12C154	12	14	120										INC		702152					
TG12C155	12	14	120										INC		702152					
TG12C172	12	14	120										INC		702152					
TG12C173	12	14	140										INC		702152					
TG12C174	11												INC		702152					
TG12C175	12	14	140										INC		702152					
TG12C176	12	14	120										INC		702152					
TG12C177	12	14	140										INC		702152					











TC									
TG12C040			702113						702006
TG12C042	702210		702113	702063					702006
TG12C043	702210	702251	702113						702006
TG12C044	702210	702251		702057					702006
TG12C045	702210	702251		702057					702006
TG12C048	702210		702113	702063					702006
TG12C052						702053			
TG12C053			702119						702002
TG12C055		702251							
TG12C056		702251	702119						702002
TG12C057	702210	702251							
TG12C059	595413		595321			588048	593563 ▲	593564 ▲	599153 ▲
TG12C062	595413		595414	593836			593563 ▲	593564 ▲	593969 ▲
TG12C063	593800		595300			588031	593563 ▲	593564 ▲	595296 ▲
TG12C065			702119		702052				702002
TG12C066		702251	702119		702052				702002
TG12C067		702251	702119	702051					702002
TG12C069						702053			
TG12C070		702251				702053			
TG12C071		702251	702119						702002
TG12C072		702251				702053			
TG12C074						702053			
TG12C076		702251				702053			
TG12C077	595413		595414			593514	593563 ▲	593564 ▲	593969 ▲
TG12C078	595413		595414			595407	593563 ▲	593564 ▲	593969 ▲
TG12C079						595441			599190 ▲
TG12C084	702210	702251	702113	702063					702006
TG12C085	702210	702251		702057					702006
TG12C086						595394			599190 ▲
TG12C087				595392					599080 ▲
TG12C090	593800		595284			595286	593563 ▲	593564 ▲	
TG12C091	595413		595414			593516	593563 ▲	593564 ▲	593969 ▲
TG12C092	595413		595414			593514	593563 ▲	593564 ▲	593969 ▲
TG12C094	595413		595414			595407	593563 ▲	593564 ▲	593969 ▲
TG12C098	702203	702251	702103	702054					
TG12C105						702053			
TG12C106	593800		599152			593832	593563 ▲	593564 ▲	599153 ▲
TG12C107						599078			599080 ▲
TG12C108	702203	702251	702103						
TG12C109	593800					593782	593563 ▲	593564 ▲	599122 ▲
TG12C110	593800					593782	593563 ▲	593564 ▲	599122 ▲
TG12C113	593147		599319			599248	593563 ▲	593564 ▲	593826 ▲
TG12C116		702251	702111			702062			702007
TG12C118	593800		599201			599158	593563 ▲	593564 ▲	
TG12C120	595413		595321			588048	593563 ▲	593564 ▲	599153 ▲
TG12C124	595413		595414			595407	593563 ▲	593564 ▲	593969 ▲
TG12C125	595413		595414			593514	593563 ▲	593564 ▲	593969 ▲
TG12C131		702251	702119						702002
TG12C138		702251							
TG12C139	593147		599319			599320	593563 ▲	593564 ▲	593826 ▲
TG12C140	593800		599201			595286	593563 ▲	593564 ▲	
TG12C141	593800		599201			599158	593563 ▲	593564 ▲	
TG12C143		702251				702053			
TG12C144						702053			
TG12C150	595413		595414			595407	593563 ▲	593564 ▲	593969 ▲
TG12C151	595413		595414			595407	593563 ▲	593564 ▲	593969 ▲
TG12C154		702251							
TG12C155									
TG12C172		702251				702053			
TG12C173						702053			
TG12C174		702251		702051					702002
TG12C175						702053			
TG12C176		702251			702052				702002
TG12C177					702052				702002









TC											TC	Info	Valeo	03
TG12C178	12	14	120									INC	702152	
TG12C179	12	14	120									INC	702152	
TG12C180	12	14	140									INC	702152	
TG12C181	12	14	120									INC	702152	
TG12C183	12	14	120									INC	702152	
TG12C184	12	14	140									INC	702152	
TG12C187	12	14	140									INC	702152	
TG12C189	12	14	120									INC	702152	
TG12C190	12	14	120									INC	702152	
TG12C191	12	14	140									INC	702152	
TG12C192	12	14	120									INC	702152	
TG12C193	12	14	140									INC	702152	
TG12C198	12	14	120	1800	104	122	CW	D	90	22	YR1615PF	INC	593689	595412 <sup>(1)</sup>
TG12C199	12	14	120	1500	104	122	CW	D	90	22	YR1615PF	INC	593689	595412 <sup>(1)</sup>
TG12S028	12													
TG12S041	13	14	120				CW	G	45	222		INC	702154	
TG12S047	12											INC	702150	
TG12S089	12	14	125				CW	G/D		154		INC	702150	
TG12S101	13	14	120	1300	98	125	CW	GD			YR208	INC	595389	
TG12S111	13	14	120	1800	98	127	CW	GD		33	YR123	INC	599197	
TG12S128	13	14	120	1800	98	127	CW				YR208	INC	595389	
TG12S217	12	14	110				CW	G	45	156				
TG13S018	13	14	120											
TG13S020	13	14	125											
TG13S023	13	14	120											
TG13S024	13	14	120									INC	702157	
TG13S026	13	14	120									INC	702157	
TG13S027	13	14	125									INC	702157	
TG13S028	13	14	125											
TG13S029	13	14	125											
TG13S030	13	14	125									INC	702150	
TG13S031	13	14	120									INC	702150	
TG13S032	13	14	120									INC	702150	
TG13S033	13	14	120									INC	702157	
TG13S034	13	14	120									INC	702157	
TG13S035	13	14	120									INC	702150	
TG14C011	12	14	140	1600	112	140	CW	D	90	30	YR208	INC	599316	
TG14C012	12	14	140	1600	112	140	CW	D	90	30	YR208	INC	599316	595220 <sup>(1)</sup>
TG14C014	12	14	140	1600	112	140	CW	D	90	30	YR208	INC	599316	
TG14C015	12	14	140	1600	112	140	CW	D	90	30	YR208	INC	599316	
TG14C016	12	14	140	1600	112	140	CW	D	90	30	YR208	INC	599316	
TG14C018	12	14	140	1600	126	146	CW	GD		36	YR133 COM VDA	INC	599233	595388 <sup>(1)</sup>
TG14C019	12	14	140	1500	133	149	CW	GD		33				595388 <sup>(1)</sup>
TG14C020	12	14	140	1500	110	145	CW	D	90	33	YR133 COM VDA	INC	599233	599321 <sup>(1)</sup>
TG14C022	12	14	140	1500	124	146	CW	D	90	36				
TG14C023	12	14	140	1600	112	140	CW	D	90	30	YR208	INC	599316	
TG14C025	12	14	140	1000	133	155	CW	GD		30	YR208	INC	599316	595388 <sup>(1)</sup>
TG14C026	12	14	140	1800	133	154	CW	D	90	30	YR208	INC	599316	595436 <sup>(1)</sup>
TG14C027	12	14	140	1800	133	154	CW	D	90	30	YR208	INC	599316	599110 <sup>(1)</sup>
TG14C028	12	14	150	1450	133	150	CW	D	90	33				599110 <sup>(1)</sup>
TG14C031	12	14	140	1400	133	140	CW	D	90	33				595436 <sup>(1)</sup>
TG14C034	12	14	140	1500	125	150	CW	D	90	30	YR208	INC	599316	599321 <sup>(1)</sup>
TG14C035	12	14	140	1500	133	150	CW	D	90	33				599110 <sup>(1)</sup>
TG14C036	12	14	140	1400	133	150	CW	D	90	30	YR208	INC	599316	599110 <sup>(1)</sup>
TG14C037	12	14	140	1400	133	150	CW	GD		33				595388 <sup>(1)</sup>
TG14C039	12	14	140	1500	133	149	CW	D	90	33				599177
TG14C040	12	14	140	1500	133	150	CW			30	YR208	INC	599316	595388 <sup>(1)</sup>
TG14C041	12	14	140	1400	133	149	CW	GD		33	YR133 COM VDA	INC	599233	599246
TG14C042	12	14	140	1500	123	146	CW	D	90	33	YR133 COM VDA	INC	599234	595453 <sup>(1)</sup>
TG14C043	12	14	140	1500	133	149	CW	D	90	33	YR133 COM VDA	INC	599233	599202 <sup>(1)</sup>
TG14C044	12	14	140	1500	133	150	CW	D	90	33				595436 <sup>(1)</sup>
TG14C046	12	14	140	1400	133	149	CW	D	90	33	YR133 COM VDA	INC	599233	599202 <sup>(1)</sup>
TG14C047	12	14	140	1500	124	146	CW	D	90	33	YR133 COM VDA	INC	599234	595453 <sup>(1)</sup>
TG14C049	12	14	140	1400	133	150	CW	D	90	33	YR133 COM VDA	INC	599233	599202 <sup>(1)</sup>

TC									
TG12C178		702251							702002
TG12C179		702251				702053			
TG12C180									702002
TG12C181		702251							702002
TG12C183		702251							702002
TG12C184									
TG12C187						702053			
TG12C189		702251							
TG12C190		702251							
TG12C191									
TG12C192		702251				702053			
TG12C193						702053			
TG12C198	595413		595414			593516	593563 ▲	593564 ▲	593969 ▲
TG12C199	595413		595414			593514	593563 ▲	593564 ▲	593969 ▲
TG12S028			702112	702061					702008
TG12S041	702206	702254				599255			702007
TG12S047	702206	702251	702112	702061					702008
TG12S089	702206	702251	702112	702061					702008
TG12S101	595390	595442	593859			593860	593563 ▲	593564 ▲	593892 ▲
TG12S111	595390	595442	593859			593860	593563 ▲	593564 ▲	599198 ▲
TG12S128	595390	595442	593859	593865			593563 ▲	593564 ▲	593892 ▲
TG12S217	702203	702250				702062			702007
TG13S018				702057					702006
TG13S020				702057					702006
TG13S023									702006
TG13S024				702061					702008
TG13S026				702058					702008
TG13S027									702008
TG13S028									702006
TG13S029				702057					
TG13S030				702057					702006
TG13S031				702058					702008
TG13S032				702058					702008
TG13S033				702058					702008
TG13S034				702058					702008
TG13S035				702058					702008
TG14C011	599205					588001	593563 ▲	593564 ▲	593991 ▲
TG14C012	599205					588018	593563 ▲	593564 ▲	593991 ▲
TG14C014	599205			593900			593563 ▲	593564 ▲	593991 ▲
TG14C015	599205					599327	593563 ▲	593564 ▲	593991 ▲
TG14C016	593561					588001	593563 ▲	593564 ▲	593991 ▲
TG14C018	595398		595358			595333	593563 ▲	593564 ▲	593991 ▲
TG14C019	595398		595358				593563 ▲	593564 ▲	593991 ▲
TG14C020	595398		595445			599248	593563 ▲	593564 ▲	593991 ▲
TG14C022	595398		595455	595308			593563 ▲	593564 ▲	593991 ▲
TG14C023	599205					599248	593563 ▲	593564 ▲	593991 ▲
TG14C025	595398		595358				593563 ▲	593564 ▲	593991 ▲
TG14C026	595398		599075			599327	593563 ▲	593564 ▲	593991 ▲
TG14C027	595398		595439			595440	593563 ▲	593564 ▲	593991 ▲
TG14C028	595398		595439			588018	593563 ▲	593564 ▲	593991 ▲
TG14C031	595398		595445			588001	593563 ▲	593564 ▲	593991 ▲
TG14C034	595398		599075			599248	593563 ▲	593564 ▲	593991 ▲
TG14C035	595398		599111			599327	593563 ▲	593564 ▲	593991 ▲
TG14C036	595398		599111			588001	593563 ▲	593564 ▲	593991 ▲
TG14C037	595398		595358				593563 ▲	593564 ▲	593991 ▲
TG14C039	595398		599178			595440	593563 ▲	593564 ▲	593991 ▲
TG14C040	595398		595358				593563 ▲	593564 ▲	593991 ▲
TG14C041	599093		599247				593563 ▲	593684 ▲	593991 ▲
TG14C042	595297		595455	595308			593563 ▲	593564 ▲	593991 ▲
TG14C043	599093		599075			599248	593563 ▲	593684 ▲	593991 ▲
TG14C044	595398		599075			599248	593563 ▲	593564 ▲	593991 ▲
TG14C046	599093		599075			599331	593563 ▲	599332	593991 ▲
TG14C047	595297		595455			599143	593563 ▲	593564 ▲	593991 ▲
TG14C049	599093		599075			599252	593563 ▲	593684 ▲	593991 ▲

TC														
	TC	i	Valeo	03										
TG14C054	12	14	140	1450	133	150	CW	D	90	33	YR133 COM VDA	INC	599233	599110 <sup>(1)</sup>
TG14C055	12	14	140	1400	133	150	CW	GD		33	YR133 COM VDA	INC	599233	595388 <sup>(1)</sup>
TG14C056	12	14	140	1450	133	149	CW	GD		33	YR133 COM VDA	INC	599233	595388 <sup>(1)</sup>
TG14C057	12	14	140	1400	133	150	CW	D	90	33	YR133 COM VDA	INC	599233	599321 <sup>(1)</sup>
TG14C058	12	14	140	1500	133	150	CW	D	90	33	YR133 COM VDA	INC	599233	599110 <sup>(1)</sup>
TG14C059	12	14	140	1500	133	150	CW	D	90	33	YR133 COM VDA	INC	599233	599177
TG14C060	12	14	140	1500	133	150	CW	D	90	33	YR133 COM VDA	INC	599233	599321 <sup>(1)</sup>
TG14C067	12	14	140	1500	133	150	CW	D	90	33	YR133 COM VDA	INC	599233	599202 <sup>(1)</sup>
TG14C068	12	14	140	1500	125	150	CW	D	90	30	YR208	INC	599316	595436 <sup>(1)</sup>
TG14C071	12	14	140	1400	133	149	CW	D	90	33	YR133 COM VDA	INC	599233	599202 <sup>(1)</sup>
TG15C012	12	14	150				CW	G	47	30	YR36 CPLE	INC	593793	
TG15C015	12	14	150	1000	139	157	CW	G	40		YR208	INC	593534	593562 <sup>(1)</sup>
TG15C017	12	14	150	1000	138	153	CW			30	YR208	INC	599316	593856 <sup>(1)</sup>
TG15C018	12	14	150				CW	G	47	32	YR124 COM	INC	593873	
TG15C018b	12	14	150				CW	G	47	32	YR124 COM	INC	593873	
TG15C020	12	14	150	1000	130	154	CW	G	40	27	YR208	INC	595354	593807 <sup>(1)</sup>
TG15C022	12	14	150	1000	139	157	CW	G	40	27	YR208	INC	595354	593807 <sup>(1)</sup>
TG15C023	12	14	150	1000	130	152	CW	G	40	21	YR208	INC	595354	593807 <sup>(1)</sup>
TG15C026	12	14	130									INC	702154	
TG15C027	12	14	150				CW	G	47	33	YR124 COM	INC	595348	
TG15C027b	12	14	150				CW	G	47	33	YR124 COM	INC	595348	
TG15C028	12	14	150	1000	130	152	CW	G	40	27	YR208	INC	595354	593807 <sup>(1)</sup>
TG15C038	12	14	150	1000	138	152	CW	G	48	30	YR36 CPLE	INC	593793	
TG15C043	12	14	150	1000	138	152	CW	G	60	30	YR208	INC	599316	595232 <sup>(1)</sup>
TG15C046	12	14	145											
TG15C047	12	14	145											
TG15C048	12	14	140	1600	120	140	CW	D	90	30	YR208	INC	599316	595338 <sup>(1)</sup>
TG15C051	12	14	145											
TG15C053	12	14	150	1000	130	154	CW	G	40	27	YR208	INC	595354	595228 <sup>(1)</sup>
TG15C054	12	14	150	1000	139	157	CW	G	40	27	YR208	INC	595354	595228 <sup>(1)</sup>
TG15C057A	12	14	140	1400	117	142	CW	GD			YM	INC	593970	593974 <sup>(1)</sup>
TG15C057B	12	14	140	1400	117	142	CW	GD		33	YM	INC	593970	593974 <sup>(1)</sup>
TG15C057C	12	14	140	1400	117	142	CW	GD		33	YM	INC	593970	593974 <sup>(1)</sup>
TG15C058	12	14	150	1800	125	152	CW	D	90	22	YR1615PF	INC	593689	595378 <sup>(1)</sup>
TG15C060	12	14	150	1000	139	157	CW	G	40		YR208	INC	595354	593807 <sup>(1)</sup>
TG15C064	12	14	150				CW	G	90	30	YR36 CPLE	INC	593793	
TG15C065	12	14	150	1000	138	154	CW			30	YR208	INC	599316	593856 <sup>(1)</sup>
TG15C072	12	14	150	1000	139	157	CW	G	95	32				
TG15C073	12	14	150	1500	131	160	CW	G	90	33				595255 <sup>(1)</sup>
TG15C075	12	14	150	1250	120	140	CW			36	YR223 COM	INC	595387	595299 <sup>(1)</sup>
TG15C086	12	14	145									INC	702157	
TG15C089	12	14	145											
TG15C090	12	14	150											
TG15C091	12	14	150	1200	125	152	CW	D	90	240	YR COM	INC	595237	595236 <sup>(1)</sup>
TG15C093	12	14	150				CW	G	47	33	YR124 COM	INC	595348	595255 <sup>(1)</sup>
TG15C094	12	14	150	1600	132	154	CW	GD		33	YR133 COM VDA	INC	599234	599180 <sup>(1)</sup>
TG15C095	12	14	150	1500	130	154	CW	D	90	33	YR133 COM VDA	INC	599234	595453 <sup>(1)</sup>
TG15C098	12	14	150				CW	G	90	32	YR124 COM	INC	593873	595255 <sup>(1)</sup>
TG15C103	12	14	150	1000	132	153	CW	G	79	33	YR233	INC	599182	595375 <sup>(1)</sup>
TG15C107	12	14	145											
TG15C108	12	14	145											
TG15C112	12	14	150	1000	139	157	CW	G	80	22	YR208	INC	595354	595361 <sup>(1)</sup>
TG15C113	11	14	130				CW	G	46	138		INC	702155	
TG15C114	11											INC	702157	
TG15C117	12	14	150	1000	139	157	CW	G	80		YR208	INC	593534	593562 <sup>(1)</sup>
TG15C118	12	14	150	1000	139	157	CW	G	80	22	YR208	INC	595354	595228 <sup>(1)</sup>
TG15C119	12	14	150	1000	139	157	CW	G	80	22	YR208	INC	595354	595228 <sup>(1)</sup>
TG15C120	12	14	150	1500	139	157	CW	G	80	21	YR208	INC	595478	593562 <sup>(1)</sup>
TG15C121	12	14	140	1400	117	142	CW			33	YM	INC	593970	595345 <sup>(1)</sup>
TG15C123	12	14	150	1800	125	152	CW	D	90	240	YR124	INC	595379	595378 <sup>(1)</sup>
TG15C124	12	14	150	1800	125	151	CW	D	90	240	YR124	INC	595379	595378 <sup>(1)</sup>
TG15C125	12	14	150	1800	125	152	CW	D	90	240	YR124	INC	595379	595378 <sup>(1)</sup>
TG15C127	12	14	150	1000	139	157	CW	G	78	22	YR208	INC	595354	595228 <sup>(1)</sup>
TG15C128	12	14	150	1800	125	151	CW	D	90	240	YR124	INC	595379	565408 <sup>(1)</sup>









TC	 04	 05	 07	 11	 11b	 11c	 21	 22	 24
TG14C054	595398		595439			595440	593563 ▲	593564 ▲	593991 ▲
TG14C055	595398		595358				593563 ▲	593564 ▲	593991 ▲
TG14C056	595398		595358				593563 ▲	593564 ▲	593991 ▲
TG14C057	595398		599075			599327	593563 ▲	593564 ▲	593991 ▲
TG14C058	595398		599111			599327	593563 ▲	593564 ▲	593991 ▲
TG14C059	595398		599178			595440	593563 ▲	593564 ▲	593991 ▲
TG14C060	595398		599075			599248	593563 ▲	593564 ▲	593991 ▲
TG14C067	599093		599075			599248	593563 ▲	593684 ▲	593991 ▲
TG14C068	595398		599075			599248	593563 ▲	593564 ▲	593991 ▲
TG14C071	599093		599075		599333		593563 ▲	599332	593991 ▲
TG15C012	593561		593788				593563 ▲	593564 ▲	593790 ▲
TG15C015	593561		593558				593563 ▲	593564 ▲	593560 ▲
TG15C017	593561		593855				593563 ▲	593564 ▲	593991 ▲
TG15C018	593561		593788	593789			593563 ▲	593564 ▲	593790 ▲
TG15C018b	593561		593914	593789			593563 ▲	593564 ▲	593790 ▲
TG15C020	593561		593803			588002	593563 ▲	593564 ▲	599076 ▲
TG15C022	593561		593803				593563 ▲	593564 ▲	599076 ▲
TG15C023	593561		593803				593563 ▲	593564 ▲	599076 ▲
TG15C026		702256							702005
TG15C027	593561		593955	593956			593563 ▲	593564 ▲	593957 ▲
TG15C027b	593561		593955	593956			593563 ▲	593564 ▲	593957 ▲
TG15C028	593561		593803			588002	593563 ▲	593564 ▲	599076 ▲
TG15C038	593561		593788	593849			593563 ▲	593564 ▲	593790 ▲
TG15C043	593561		595230	595231			593563 ▲	593564 ▲	593991 ▲
TG15C046		702256							
TG15C047		702256		702061					
TG15C048	593561			593900			593563 ▲	593564 ▲	593991 ▲
TG15C051		702256							
TG15C053	593561		593803			588002	593563 ▲	593564 ▲	599076 ▲
TG15C054	593561		593803				593563 ▲	593564 ▲	599076 ▲
TG15C057A	593973		593971			599104	593563 ▲	593564 ▲	593972 ▲
TG15C057B	593973		593971			588025	593563 ▲	593564 ▲	593972 ▲
TG15C057C	593973		593971			588025	593563 ▲	593564 ▲	593972 ▲
TG15C058	595380		595233			588027	593563 ▲	593564 ▲	595235 ▲
TG15C060	599205		595304			595432	593563 ▲	593564 ▲	593528 ▲
TG15C064	599205		593914	595272			593563 ▲	593564 ▲	593790 ▲
TG15C065	599205		593855				593563 ▲	593564 ▲	593991 ▲
TG15C072	599205		593914	595272			593563 ▲	593564 ▲	593790 ▲
TG15C073	593973		595343	595278			593563 ▲	593564 ▲	593957 ▲
TG15C075	595297		595298			595258	593563 ▲	593564 ▲	593790 ▲
TG15C086		702256	702115	702058					702008
TG15C089		702256							702006
TG15C090		702256		702061					702006
TG15C091	593561		595233			595226	593563 ▲	593564 ▲	595235 ▲
TG15C093	593973		593955	593956			593563 ▲	593564 ▲	593957 ▲
TG15C094	595297		595358			595333	593563 ▲	593564 ▲	593991 ▲
TG15C095	595297		595455	595308			593563 ▲	593564 ▲	593991 ▲
TG15C098	593973		593914	595254			593563 ▲	593564 ▲	593790 ▲
TG15C103	595297		595376			588002	593563 ▲	593564 ▲	599190 ▲
TG15C107		702256							702006
TG15C108		702256		702061					702006
TG15C112	599205		595359			595360	593563 ▲	593564 ▲	599076 ▲
TG15C113		702256		702065					702007
TG15C114		702256	702115		702064				702008
TG15C117	593561		593558	595479			593563 ▲	593564 ▲	593560 ▲
TG15C118	599205		593803			588002	593563 ▲	593564 ▲	599076 ▲
TG15C119	599205		593803				593563 ▲	593564 ▲	599076 ▲
TG15C120	593561		593558	595479			593563 ▲	593564 ▲	595480 ▲
TG15C121	593973		595346			588025	593563 ▲	593564 ▲	593972 ▲
TG15C123	595380		595233			595410	593563 ▲	593564 ▲	595235 ▲
TG15C124	595380		595233	593836			593563 ▲	593564 ▲	595235 ▲
TG15C125	595380		595233			593514	593563 ▲	593564 ▲	595235 ▲
TG15C127	599205		593803			593832	593563 ▲	593564 ▲	599076 ▲
TG15C128	595380		595406			595410	593563 ▲	593564 ▲	595235 ▲

TC														
	TC	i	Valeo	03										
TG15C130	12	14	150	1300	135	168	CW	GD		36	YR133 COM VDA	INC	599302	595443 <sup>(1)</sup>
TG15C131	12	14	150	1800	120	145	CW			33				595443 <sup>(1)</sup>
TG15C133	12	14	150	1500	120	140	CW	GD		33	YR223 COM	INC	595387	595489 <sup>(1)</sup>
TG15C134	12	14	150	1000	139	157	CW	G	80	27	YR208	INC	595354	599214 <sup>(1)</sup>
TG15C135	12	14	150	1000	139	157	CW	G	78	17				595481 <sup>(1)</sup>
TG15C137	12	14	150	1800	128	159	CW	D	90	22	YR1615PF	INC	593689	595405 <sup>(1)</sup>
TG15C139	12	14	145											
TG15C140	12	14	145											
TG15C141	12	14	150	1800	128	160	CW	D	90	240	YR124	INC	595379	595402 <sup>(1)</sup>
TG15C142	12	14	150	1000	128	160	CW	D	90	60	YR124	INC	595379	595405 <sup>(1)</sup>
TG15C143	12	14	150	1000	128	160	CW	D	90	60	YR124	INC	595379	595402 <sup>(1)</sup>
TG15C144	12	14	150	1500	132	154	CW	GD	60	33	YR133 COM VDA	INC	599234	599180 <sup>(1)</sup>
TG15C145	12	14	150	1500	132	154	CW			33	YR133 COM VDA	INC	599234	599180 <sup>(1)</sup>
TG15C146	12	14	150	1000	128	160	CW	D	90	240	YR124	INC	595379	595405 <sup>(1)</sup>
TG15C148	12	14	150	2100										
TG15C149	12	14	150	1500	133	154	CW	D	90	33	YR133 COM VDA	INC	599234	599074
TG15C152	12	14	150	1300	144	156	CW	G	90	33	YR233	INC	599182	
TG15C154	12	14	150	1000	139	157	CW	G	78	22	YR208	INC	595354	595492 <sup>(1)</sup>
TG15C156	12	14	150	1500	139	157	CW	GD	78	22	YR208	INC	595354	595490 <sup>(1)</sup>
TG15C157	12	14	150	1500	131	160	CW	G	95	33	YR124 COM	INC	595348	595255 <sup>(1)</sup>
TG15C158	12	14	145									INC	702157	
TG15C159	11	14	145				CW	G/D		154		INC	702157	
TG15C165	12	14	150	1050	132	154	CW	D	90	30	YR208	INC	599316	599074
TG15C169	12	14	150	1300	144	156	CW	G	80	33				599092 <sup>(2)</sup>
TG15C177	12	14	150	1500	132	154	CW	GD		33	YR COM	INC	599199	599180 <sup>(1)</sup>
TG15C180	12	14	130									INC	702154	
TG15C181	12	14	150	1500	120	143	CW	GD		33				595443 <sup>(1)</sup>
TG15C182	12	14	150	1300	138	172	CW	GD		36	YR133 COM VDA	INC	599302	595443 <sup>(1)</sup>
TG15C189	12	14	150	1000	139	157	CW	G	78	17	YR233	INC	599240	599214 <sup>(1)</sup>
TG15C190	12	14	150	1000	132	154	CW	D	90	33	YR133 COM VDA	INC	599234	595453 <sup>(1)</sup>
TG15C194	12	14	150	1000	139	157	CW	G	78	17	YR233	INC	599240	599214 <sup>(1)</sup>
TG15C195	12	14	150	1000	139	157	CW	G	79		YR233	INC	599240	599343
TG15C196	12	14	150	1500	118	138	CW	GD		32	YR133 COM VDA	INC	599234	599180 <sup>(1)</sup>
TG15C200	12	14	150	1500	119	145	CW	G	95	33	COM VDA	INC	599326	595255 <sup>(1)</sup>
TG15S039	12											INC	702157	
TG15S079	12	14	145				CW	G	60	154		INC	702157	
TG15S147	12	14	130				CW	G	46	138		INC	702155	
TG15S179	12	14	130				CW	G	46	138		INC	702155	
TG15S192	12	14	130				CW	G	46	138				
TG15S205	13	14	150	1000	137	155	CW	G	79	17	YR233	INC	599240	599346
TG16C010	12	14	150	1500	135	153	CW			32	YR COM	INC	595457	593925 <sup>(1)</sup>
TG16C011	12	14	150	1000	138	152	CW			30	YR208	INC	595339	593925 <sup>(1)</sup>
TG16C012	12	14	150	1200	137	152	CW	D	90	32	YR COM	INC	595458	593968 <sup>(1)</sup>
TG16C013	12	14	150	1200	138	152	CW	D	90	30	YR208	INC	595339	593968 <sup>(1)</sup>
TG16C014	12	14	150	18000	137	153	CW			32	YR COM	INC	595457	593925 <sup>(1)</sup>
TG17C010	12	14	170				CW	G	95	32	YR124 COM	INC	599101	
TG17C010b	12	14	170				CW	G	95	32	YR124 COM	INC	599101	
TG17C011	12	14	170	1500	152	178	CW	G	90	32	YR124 COM	INC	599101	
TG17C015	12	14												595204 <sup>(1)</sup>
TG17C016	12	14	170				CW	G	95	33	YR124 COM	INC	599102	
TG17C016b	12	14	170				CW	G	95	33	YR124 COM	INC	599102	593882 <sup>(1)</sup>
TG17C019	12	14	180	1600	155	184	CW	D	90	30	YR208	INC	595339	593901 <sup>(1)</sup>
TG17C020	12	14	180	1600	155	184	CW	D	90	32	YR COM	INC	595458	593901 <sup>(1)</sup>
TG17C021	12	14	180				CW	G	47	33	YR124 COM	INC	599102	593882 <sup>(1)</sup>
TG17C021b	12	14	180				CW	G	47	33	YR124 COM	INC	599102	593882 <sup>(1)</sup>
TG17C022	12	14	180	1600	145	184	CW	D	90	32	YR COM	INC	595458	593933 <sup>(1)</sup>
TG17C023	12	14	180	1600	155	184	CW			36	YR COM	INC	595458	593922 <sup>(1)</sup>
TG17C024	12	14	180	1600	155	184	CW	D	90	32	YR COM	INC	595458	593901 <sup>(1)</sup>
TG17C026	12	14	180	1600	137	160	CW			33	YR COM	INC	595238	593988 <sup>(1)</sup>
TG17C027	12	14	180				CW	G	47	33	YR124 COM	INC	599102	593882 <sup>(1)</sup>
TG17C027b	12	14	180				CW	G	47	33	YR124 COM	INC	599102	593882 <sup>(1)</sup>
TG17C028	12	14	180	1600	138	160	CW			32	YM	INC	595243	593988 <sup>(1)</sup>
TG17C030	12	14	180	1600	137	160	CW	GD		32	YM	INC	595243	593962 <sup>(1)</sup>
TG17C030b	12	14	180	1600	138	160	CW			32	YM	INC	595243	593988 <sup>(1)</sup>

TC	 04	 05	 07	 11	 11b	 11c	 21	 22	 24
TG15C130	593973		595346			588031	593563 ▲	593564 ▲	593961 ▲
TG15C131	593973		595346			588031	593563 ▲	593564 ▲	593957 ▲
TG15C133	595297		595298			588031	593563 ▲	593564 ▲	593790 ▲
TG15C134	595482		595483			593832	593563 ▲	593564 ▲	595484 ▲
TG15C135	595482		595483			593832	593563 ▲	593564 ▲	595494 ▲
TG15C137	595403		595406	593836			593563 ▲	593564 ▲	595235 ▲
TG15C139	702200	702256							702006
TG15C140	702200	702256		702061					702006
TG15C141	595403		595233	593836			593563 ▲	593564 ▲	595235 ▲
TG15C142	595403		595406			593514	593563 ▲	593564 ▲	595235 ▲
TG15C143	595403		595233			593514	593563 ▲	593564 ▲	595235 ▲
TG15C144	595297		595358				593563 ▲	593564 ▲	593991 ▲
TG15C145	595297		595358			588084	593563 ▲	593564 ▲	593991 ▲
TG15C146	595403		595406			595407	593563 ▲	593564 ▲	595235 ▲
TG15C148						595360			599190 ▲
TG15C149	595297		595445			588016	593563 ▲	593564 ▲	593991 ▲
TG15C152						593832			599190 ▲
TG15C154	599205		595359			595360	593563 ▲	593564 ▲	595484 ▲
TG15C156	599205		593803				593563 ▲	593564 ▲	595484 ▲
TG15C157	593973		599117	599118			593563 ▲	593564 ▲	593957 ▲
TG15C158	702200	702256	702115	702058					702008
TG15C159	702200	702256	702115		702064				702008
TG15C165	595297		599075			599248	593563 ▲	593564 ▲	593991 ▲
TG15C169	599093		595376			595395	593563 ▲	593684 ▲	599190 ▲
TG15C177	595297		595358				593563 ▲	593564 ▲	593991 ▲
TG15C180	702200								702005
TG15C181	593973		595346	595368			593563 ▲	593564 ▲	593957 ▲
TG15C182	593973		595346	595368			593563 ▲	593564 ▲	593961 ▲
TG15C189	595482		595483			593832	593563 ▲	593564 ▲	595494 ▲
TG15C190	595297		595455			599143	593563 ▲	593564 ▲	593991 ▲
TG15C194	595482		595483			593832	593563 ▲	593564 ▲	595494 ▲
TG15C195	599344		599345	599338			593563 ▲	593564 ▲	595494 ▲
TG15C196	595297		595358				593563 ▲	593564 ▲	593991 ▲
TG15C200	593973		599117	599118			593563 ▲	593564 ▲	593957 ▲
TG15S039		702256	702109	702057					
TG15S079		702256	702109	702057					702006
TG15S147		702256	702101	702065					702007
TG15S179		702256	702101	702065					702007
TG15S192	702200	702256	702101	702065					702007
TG15S205	599344		599347			593832	593563 ▲	593564 ▲	595494 ▲
TG16C010	593285		593924			588084	593563 ▲	593564 ▲	593991 ▲
TG16C011	593285		593924			588084	593563 ▲	593564 ▲	593991 ▲
TG16C012	593285		593899	593900			593563 ▲	593564 ▲	593991 ▲
TG16C013	593285		593899	593900			593563 ▲	593564 ▲	593991 ▲
TG16C014	593285		593924				593563 ▲	593564 ▲	593991 ▲
TG17C010	593798						593563 ▲	593564 ▲	593790 ▲
TG17C010b	593798			595272			593563 ▲	593564 ▲	593790 ▲
TG17C011	593798			593985			593563 ▲	593564 ▲	593790 ▲
TG17C015	593881		595202			595203	593563 ▲	593684 ▲	595270 ▲
TG17C016				595269				593564 ▲	
TG17C016b	593881		593878	595269			593563 ▲	593684 ▲	595270 ▲
TG17C019	593798		593899			588001	593563 ▲	593564 ▲	593991 ▲
TG17C020	593798		593899	593900			593563 ▲	593564 ▲	593991 ▲
TG17C021	593881		593878	593879			593563 ▲	593684 ▲	593880 ▲
TG17C021b	593881		593878	593879			593563 ▲	593684 ▲	593880 ▲
TG17C022	593798		593932	593900			593563 ▲	593564 ▲	593921 ▲
TG17C023	593798		595459			588084	593563 ▲	593564 ▲	593921 ▲
TG17C024	593798		593899			588001	593563 ▲	593564 ▲	593991 ▲
TG17C026	593798		593959				593563 ▲	593564 ▲	593957 ▲
TG17C027	593881		593878	593917			593563 ▲	593684 ▲	593880 ▲
TG17C027b	593881		593878	593917			593563 ▲		593880 ▲
TG17C028	593798		593959			588072	593563 ▲	593564 ▲	593961 ▲
TG17C030	593798		593959			588049	593563 ▲	593564 ▲	593961 ▲
TG17C030b	593881		593959			588049	593563 ▲	593564 ▲	593961 ▲

															 <b>Valeo</b>			
TG17C032	12	14	180	1600	137	160	CW			32	YM	INC	595243	593988 <sup>(1)</sup>				
TG17C034	12	14	170				CW	G	95	33	YR124 COM	INC	599102					
TG17C035	12	14	180				CW	G	95	33	YR COM	INC	593984	593882 <sup>(1)</sup>				
TG17C036	12	14	180				CW	G	95	33	YR124 COM	INC	599102	595268 <sup>(1)</sup>				
TG17C039	12	14	180	1500	155	184	CW	D	90	32	YR COM	INC	595458	593933 <sup>(1)</sup>				
TG17C040	12	14	180	1600	157	184	CW			32	YR COM	INC	595458	595241 <sup>(1)</sup>				
TG17C041	12	14	180	1600	138	160	CW	GD		32	YM	INC	595243	595246 <sup>(1)</sup>				
TG17C044	12	14	180	1600	155	184	CW			36	YR COM	INC	595458	593922 <sup>(1)</sup>				
TG17C048	12	14	170				CW	G	95	32	YR124 COM	INC	599101					
TG17C052	12	14	170				CW											
TG17C054	12	14	180	1600	155	184	CW	D	90	32	YR COM	INC	595458	593901 <sup>(1)</sup>				
TG17C056	12	14	180	1600	155	184	CW	D	90	32	YR COM	INC	595458	593901 <sup>(1)</sup>				
TG17C061	12	14	180	1600	137	160	CW			33	YR VDA	INC	599317	595246 <sup>(1)</sup>				
TG17C062	12	14	180	1800	155	180	CW	D	90	30	YR208	INC	595339	593933 <sup>(1)</sup>				
TG17C065	12	14	180	1600	155	184	CW			32	YR COM	INC	595458	595241 <sup>(1)</sup>				
TG17C066	12	14	180	1600	155	184	CW	D	90	30	YR208	INC	595339	593901 <sup>(1)</sup>				
TG17C072	12	14	180	1600	155	184	CW	D	90	32	YR COM	INC	595458	593901 <sup>(1)</sup>				
TG23C011	12	14	230				CW	G	95	33	YR 223	INC	599232	595275 <sup>(1)</sup>				
TG23C012	12	14	230				CW	G	95	33	YR 223	INC	599232	595280 <sup>(1)</sup>				
TG23C013	12	14	230		187	224	CW	GD		33	YR 223	INC	599232	595276 <sup>(1)</sup>				
TG23C017	12	14	220	1250	154	187	CW			33	YR COM VDA	INC	599296	595349 <sup>(1)</sup>				
TG23C018	12	14	230	1500	187	216	CW		33	33	YR 223	INC	599232	595351 <sup>(1)</sup>				
TG23C019	12	14	220	1450	152	186	CW			33 / W	YR COM VDA	INC	599296	595288 <sup>(1)</sup>				
TG23C022	12	14	220	1200	154	187	CW			30	YR208	INC	595324	595349 <sup>(1)</sup>				
TG23C033	12	14	230	1500	187	216	CW		33	33	YR 223	INC	599232	595351 <sup>(1)</sup>				
TG23C034	12	14	220	1300	160	190	CW			33	YR COM VDA	INC	599296	595349 <sup>(1)</sup>				
TG23C035	12	14	220	1450	160	186	CW			33	YR COM VDA	INC	599296	595288 <sup>(1)</sup>				



TC	 04	 05	 07	 11	 11b	 11c	 21	 22	 24
TG17C032	599230		593959			595239	593563 ▲	593564 ▲	593961 ▲
TG17C034	593798		595279	595278			593563 ▲	593564 ▲	593957 ▲
TG17C035	593881		593878	593879			593563 ▲	593684 ▲	595270 ▲
TG17C036	593881		593878	595269			593563 ▲	593684 ▲	595270 ▲
TG17C039	593798		595400			588096	593563 ▲	593564 ▲	593921 ▲
TG17C040	593798		593924			595341	593563 ▲	593564 ▲	593991 ▲
TG17C041	593881		593924			588031	593563 ▲	593564 ▲	593790 ▲
TG17C044	593798		595459			588084	593563 ▲	593564 ▲	593921 ▲
TG17C048	593798			595272			593563 ▲	593564 ▲	593790 ▲
TG17C052	593798			593985				593564 ▲	593790 ▲
TG17C054	593798		593899			588001	593563 ▲	593564 ▲	593991 ▲
TG17C056	593798		593899			595340	593563 ▲	593564 ▲	593991 ▲
TG17C061	593881		595344			588031	593563 ▲	593564 ▲	593790 ▲
TG17C062	593798		595400	595401			593563 ▲	593564 ▲	595367 ▲
TG17C065	593798		593924				593563 ▲	593564 ▲	593991 ▲
TG17C066	593798		593899			599248	593563 ▲	593564 ▲	593991 ▲
TG17C072	593798		593899	593900			593563 ▲	593564 ▲	593991 ▲
TG23C011	595274		595273	595269			593563 ▲	593684 ▲	595270 ▲
TG23C012	595274		595273	595281			593563 ▲	593684 ▲	595270 ▲
TG23C013	595274		595277			595264	593563 ▲	593684 ▲	595270 ▲
TG23C017	595274		595289			588031	593563 ▲	593684 ▲	595290 ▲
TG23C018	595274		595277	595350			593563 ▲	593684 ▲	595270 ▲
TG23C019	595274		595289				593563 ▲	593684 ▲	595290 ▲
TG23C022	595274		595289			588031	593563 ▲	593684 ▲	595290 ▲
TG23C033	595274		595277	595350			593563 ▲	593684 ▲	595270 ▲
TG23C034	595274		595289	595368			593563 ▲	593684 ▲	595290 ▲
TG23C035	595274		595289	599184			593563 ▲	593684 ▲	595290 ▲

---

**NOTES NOTES NOTAS NOTAS NOTE NOTITIES NOTIZEN NOTATAKI NOT ПРИМЕЧАНИЯ POZNAMKY**

---



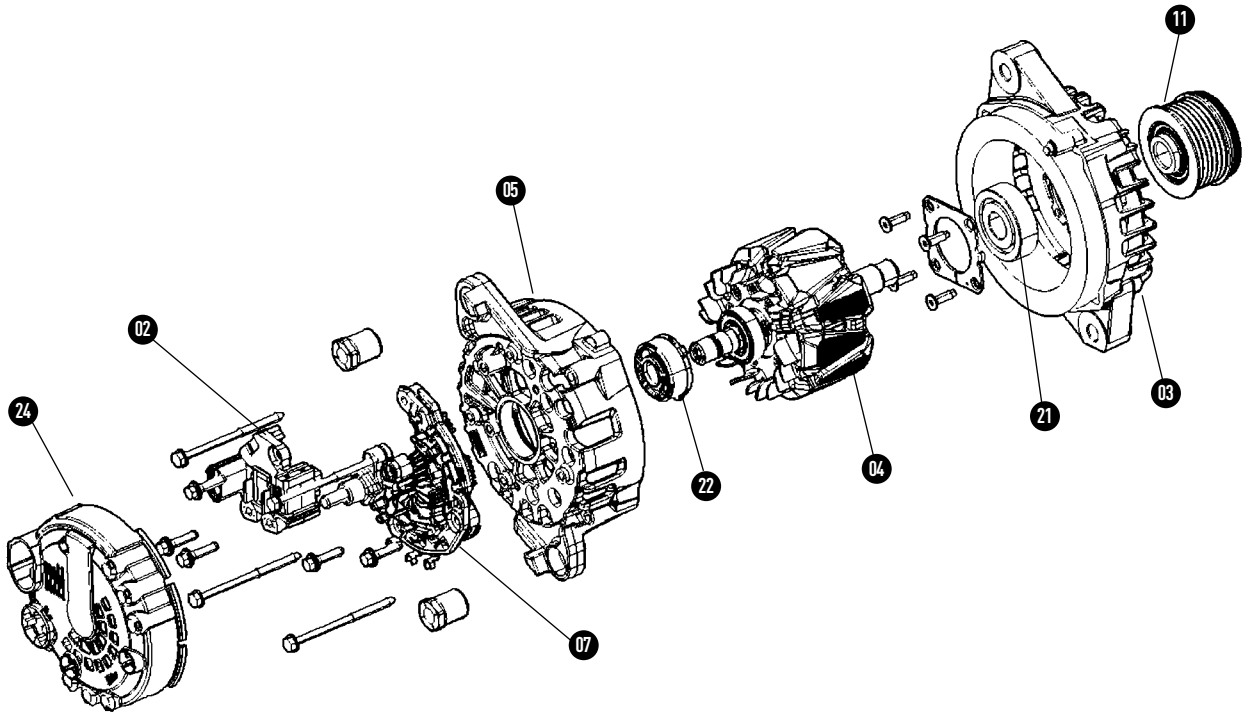



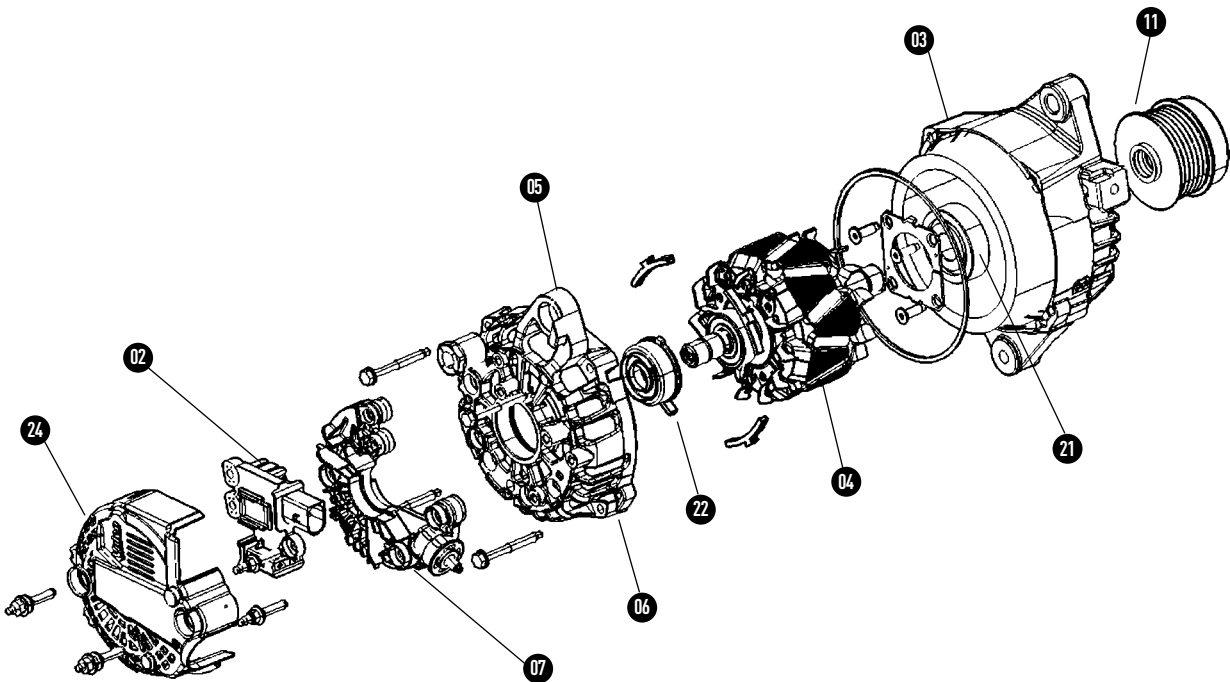



## 14 FGN/S













## 15 FGN/T



TC												TC	i	Valeo	02	
	TC	i	Valeo	02	03											
FG9T011	15	14	90	1500	80	90	CW	G	8	96	YR COM	INC	599162	599163		
FG9T012	15	14	90	1500	80	90	CW	G	28	96	YR COM	INC	599162	599206		
FG12S010	14	14	130				CW	G/D		20		INC	702150			
FG12S011	14	14	130									INC	702150			
FG12S012	14	14	130				CW	G/D		154						
FG12S014	14															
FG12S017	14															
FG12S018	14	14	130									INC	702157			
FG12S019	14	14	130									INC	702157			
FG12S020	14	14	130				CW	G/D		154		INC	702150			
FG12S023	14	14	130				CW	G/D		20		INC	702150			
FG12S024	14	14	130									INC	702150			
FG12S025	14	14	130									INC	702157			
FG12S026	14	14	130									INC	702157			
FG12S028	14	14	130				CW	G/D		154		INC	702150			
FG12S031	14	14	130				CW	G	30	58						
FG12S032	14	14	130				CW	D	40	58						
FG12S043	14															
FG12S045	14	14	130				CW	G/D		20		INC	702150			
FG12S047	14	14	130													
FG12S048	14	14	130				CW	G	30	58						
FG12S054	14	14	130				CW	G	30	58						
FG12S055	14	14	130				CW	D	40	58						
FG12S064	14	14	130				CW	G	30	58		INC	702152			
FG12S065	14	14	130				CW	G	30	58		INC	702152			
FG12S070	14	14	130				CW	D	40	58		INC	702152			
FG12S071	14											INC	702152			
FG12S072	14	14	130									INC	702152			
FG12S078	14											INC	702152			
FG12S081	14											INC	702152			
FG12S085	14	14	130				CW	G/D		20		INC	702150			
FG12T039	14	14	110				CW	G	90	156		INC	702155			
FG12T050	14	14	115				CW	G	3	30						
FG15S019	14	14	150				CW	D	48	154						
FG15S023	14	14	150													
FG15S024	14	14	150				CW	G/D		50		INC	702151			
FG15S026	14	14	150				CW	G/D		58						
FG15S027	14	14	150													
FG15S032	14	14	150													
FG15S046	14	14	150				CW	G/D		33						
FG15S059	14	14	130													
FG15S060	14	14	150													
FG15S061	14	14	150													
FG15S065	14	14	150				CW	G/D		33						
FG15S068	14	14	150													
FG15S081	14	14	150				CW	G/D		58		INC	702153			
FG15S082	14	14	150									INC	702153			
FG15S083	14	14	150									INC	702153			
FG15S084	14	14	150				CW	D	48	154						
FG15S090	14	14	150				CW	G/D		50		INC	702151			
FG15S091	14	14	150				CW	G/D		33						
FG15S097	14	14	150				CW	D	48	154		INC	702153			
FG15S110	14	14	150													
FG15T030	15	14	150	1800	129		CW	D	90	60	YR124	INC	599173	599174 <sup>(1)</sup>		
FG15T036	15	14	150	1750	118	140	CW	GD		33	YR COM VDA	INC	599306	599085 <sup>(1)</sup>		
FG15T040	15	14	150	1300	128	142	CW	G	80	33						
FG15T044	15	14	150	950	139	157	CW	GD		17	YR124 COM	INC	599154	599155		
FG15T045	15	14	150	1300	128	142	CW	D	18	33	YR233	INC	599182			
FG15T050	15	14	150	1800	129		CW	D	90	22	YR1615PF	INC	593689	599174 <sup>(1)</sup>		
FG15T056	15	14	150	1800	129		CW	G	90	240	YR124	INC	599173	599174 <sup>(1)</sup>		
FG15T057	15	14	150	1800	129		CW	D	90	60	YR143	INC	599271	599174 <sup>(1)</sup>		
FG15T072	15	14	150	950	139	157	CW	GD		17	YR124 COM	INC	599154	599155		
FG15T079	15	14	150	1500	115	136	CW	GD		33				599085 <sup>(1)</sup>		
FG17T010	15	14	170	1300	158	171	CW	D	19	33	YR233	INC	599182			











TC											
FG9T011	599164	599165		599166		599167			599168 ▲	593564 ▲	599170 ▲
FG9T012	599164	599207		599208			599209		599168 ▲	593564 ▲	599170 ▲
FG12S010				702114		702058					702010
FG12S011		702253				702058					702010
FG12S012	702208	702253		702114							
FG12S014	702208			702114		702051					
FG12S017	702208	702253		702114							
FG12S018				702114		702058					702010
FG12S019						702058					702010
FG12S020				702114		702059					702010
FG12S023				702114		702058					702010
FG12S024		702253				702058					702010
FG12S025		702253		702114		702058					702010
FG12S026		702253				702058					702010
FG12S028				702114		702059					702010
FG12S031	702201						702053				
FG12S032	702201			702107			702053				
FG12S043	702201			702107							
FG12S045	702201			702114		702058					702010
FG12S047	702208	702253		702114							
FG12S048	702201										
FG12S054	702201										
FG12S055	702201			702107			702053				
FG12S064	702201						702053				702004
FG12S065	702201										702004
FG12S070	702201			702107			702053				702004
FG12S071	702201			702107							702004
FG12S072	702208	702259		702114							
FG12S078	702208			702114							702259
FG12S081	702208			702114		702051					702259
FG12S085	702201	702253				702058					702010
FG12T039		702252		702105			702056				702003
FG12T050		702252		702106							
FG15S019	702209			702118		702059					
FG15S023	702209	702260				702061					702010
FG15S024	702202			702100		702050					702001
FG15S026	702209			702118			702052				
FG15S027	702209										
FG15S032	702209	702260									
FG15S046	702202			702104			702055				
FG15S059	702205										
FG15S060	702205										
FG15S061	702209	702260									
FG15S065	702202			702104							
FG15S068	702209	702260				702061					
FG15S081	702204			702118			702052				702004
FG15S082	702204	702260				702061					702004
FG15S083	702204										702004
FG15S084	702204			702118		702059					
FG15S090		702253		702100		702050					702001
FG15S091	702205			702104							
FG15S097	702204	702260		702118		702059					702004
FG15S110		702253									
FG15T030	599175			599176			593514	593563 ▲	593684 ▲	593969 ▲	
FG15T036	599084		599086				588031	593563 ▲	593684 ▲	595296 ▲	
FG15T040							595441				
FG15T044	599222			599157			595317	593563 ▲	593684 ▲	599153 ▲	
FG15T045							599078				599080 ▲
FG15T050	599175			599176			595407	593563 ▲	593684 ▲	593969 ▲	
FG15T056	599175			599176			595407	593563 ▲	593684 ▲	593969 ▲	
FG15T057	599175			599176			595407	593563 ▲	593684 ▲	593969 ▲	
FG15T072	599222			599157			595317	593563 ▲	593684 ▲	599153 ▲	
FG15T079	599222		599086					593563 ▲	593684 ▲	595296 ▲	
FG17T010							599078				599080 ▲



TC											
FG/FGN18D024	595463	595311		595364					593563 ▲	593684 ▲	595270 ▲
FG/FGN18D037	595463			599115	599113				593563 ▲	593684 ▲	599116 ▲
FG/FGN18D057	595463			595364				599094	593563 ▲	593684 ▲	599112 ▲
FG/FGN18D111	595463			595364				599094	593563 ▲	593684 ▲	599112 ▲
FG/FGN18S011	599108			595364					593563 ▲	593684 ▲	595270 ▲
FG/FGN18S012	599108			599172				588031	593563 ▲	593684 ▲	595290 ▲
FG/FGN18S013	599108			595329		595326			593563 ▲	593684 ▲	593921 ▲
FG/FGN18S014	599108			595426		595331			593563 ▲	593684 ▲	593921 ▲
FG/FGN18S016	599108			595370		595368			593563 ▲	593684 ▲	595367 ▲
FG/FGN18S017	595312			595353				593832	593563 ▲	593684 ▲	595355 ▲
FG/FGN18S019	599108			595364					593563 ▲	593684 ▲	595270 ▲
FG/FGN18S022				595313				595309	593563 ▲	593684 ▲	593921 ▲
FG/FGN18S023				595314		595310			593563 ▲	593684 ▲	593921 ▲
FG/FGN18S027	599193			595353				593832	593563 ▲	593564 ▲	595498 ▲
FG/FGN18S029	599108			599126		595368			593563 ▲	593684 ▲	599069 ▲
FG/FGN18S032	599108			599172		595368			593563 ▲	593684 ▲	599069 ▲
FG/FGN18S036	599108			595329				595425	593563 ▲	593684 ▲	593921 ▲
FG/FGN18S039	599108			599071		599106			593563 ▲	593684 ▲	595270 ▲
FG/FGN18S040	599108			595370					593563 ▲	593684 ▲	595367 ▲
FG/FGN18S043	599108			595499		595308			593563 ▲	593684 ▲	593921 ▲
FG/FGN18S044	599108			599068					593563 ▲	593684 ▲	599109 ▲
FG/FGN18S045	599108			595364				599094	593563 ▲	593684 ▲	599112 ▲
FG/FGN18S046	599108			599172		595368			593563 ▲	593684 ▲	599109 ▲
FG/FGN18S047	599108			599172				588031	593563 ▲	593684 ▲	595270 ▲
FG/FGN18S048	599193			595353				593832	593563 ▲	593564 ▲	595496 ▲
FG/FGN18S052	599108			595364				599094	593563 ▲	593684 ▲	599112 ▲
FG/FGN18S056	599108			599129					593563 ▲	593684 ▲	599130 ▲
FG/FGN18S060	599108			595364					593563 ▲	593684 ▲	599112 ▲
FG/FGN18S061	599108			599126				599105	593563 ▲	593684 ▲	599069 ▲
FG/FGN18S066	599108			595364					593563 ▲	593684 ▲	599112 ▲
FG/FGN18S073	599108			599071				599105	593563 ▲	593684 ▲	595270 ▲
FG/FGN18S077	599108			599172		595368			593563 ▲	593684 ▲	599069 ▲
FG/FGN18S078	599108			599129		599184			593563 ▲	593684 ▲	599130 ▲
FG/FGN18S083	599108			599172		595368			593563 ▲	593684 ▲	595270 ▲
FG/FGN18S093				595314				599225	593563 ▲	593684 ▲	593921 ▲
FG/FGN18S095	599193			595353				593832	593563 ▲	593564 ▲	595498 ▲
FG/FGN18S097	599250			599298		595368			593563 ▲	593684 ▲	599299 ▲
FG/FGN18S098	599108			599172				599105	593563 ▲	593684 ▲	599069 ▲
FG/FGN18S099	599108			599172				599105	593563 ▲	593684 ▲	599109 ▲
FG/FGN18S100				595499				599143	593563 ▲	593684 ▲	593921 ▲
FG/FGN18S108				595313				595309	593563 ▲	593684 ▲	593921 ▲
FG/FGN18S109				595314		595310			593563 ▲	593684 ▲	593921 ▲
FG/FGN18S110	599108			599126		595368			593563 ▲	593684 ▲	599069 ▲
FG/FGN18S127	599250			599172		595368			593563 ▲	593684 ▲	595270 ▲
FG/FGN18S128	599250			599172		595368			593563 ▲	593684 ▲	599069 ▲
FG/FGN18S130	599250			599172					593563 ▲	593684 ▲	599069 ▲
FG/FGN18S133				595314		595310			593563 ▲	593564 ▲	593921 ▲
FG/FGN18S134				595314				599225	593563 ▲	593564 ▲	593921 ▲
FG/FGN18S135				595313				595309	593563 ▲	593564 ▲	593921 ▲
FG/FGN18S138				599071				599293	593563 ▲	593684 ▲	595270 ▲
FG/FGN18S141	599323			595364				599094	593563 ▲	593684 ▲	599112 ▲
FG/FGN18T033				595437				588001	593563 ▲	593564 ▲	593991 ▲
FG/FGN18T041				595437				595448	593563 ▲	593564 ▲	593991 ▲
FG/FGN18T042				599066		595308			593563 ▲	593564 ▲	593991 ▲
FG/FGN18T051				595437				599327	593563 ▲	593564 ▲	593991 ▲
FG/FGN18T062				595437				588016	593563 ▲	593564 ▲	593991 ▲
FG/FGN18T063				599100					593563 ▲	593564 ▲	593991 ▲
FG/FGN18T070				595437				595448	593563 ▲	593564 ▲	593991 ▲
FG/FGN18T071				599066		595308			593563 ▲	593564 ▲	593991 ▲
FG/FGN18T072				599066		599137			593563 ▲	593564 ▲	593991 ▲
FG/FGN18T074				599100					593563 ▲	593564 ▲	593991 ▲
FG/FGN18T079	599195			595437				599248	593563 ▲	593564 ▲	593991 ▲
FG/FGN18T084	599231								593563 ▲	593564 ▲	593991 ▲
FG/FGN18T094				599066				599143	593563 ▲	593564 ▲	593991 ▲

TC														
	TC	i	Valeo											
FG/FGN18T101	15	14	180	1300	155	184	CW	D	90	33	YR133 COM VDA	INC	599236	599202 <sup>(1)</sup>
FG/FGN18T106	15	14	180	1000	164	188	CW	G	79	17	YR233	INC	599187	599336
FG/FGN18T112	15	14	180	1000	164	188	CW	G	78	17	YR233	INC	599187	599257 <sup>(1)</sup>
FG/FGN18T115	15	14	180	1300	155	184	CW	D	90	30	YR208	INC	599316	599272
FG/FGN18T117	15	14	180	1500	155	184	CW	GD		30	YR208	INC	599316	599273
FG/FGN18T118	15	14	180	1500	155	183	CW	D	90	30	YR208	INC	599316	599272
FG/FGN18T119	15	14	180	1500	155	184	CW	D	90	33	YR133 COM VDA	INC	599236	599272
FG/FGN18T120	15	14	180	1500	155	184	CW	D	90	33	YR133 COM VDA	INC	599236	599274
FG/FGN18T121	15	14	180	1500	155	184	CW	D	90	33	YR133 COM VDA	INC	599236	599272
FG/FGN18T122	15	14	180	1500	155	184	CW	D	90	33	YR133 COM VDA	INC	599236	599274
FG/FGN18T123	15	14	180	1500	155	184	CW	D	90	33	YR133 COM VDA	INC	599236	599202 <sup>(1)</sup>
FG/FGN20S011	14	14	180	1500	162	180	CW	D	90	33	YR COM	INC	599191	599051
FG/FGN20S014	14	14	180	1500	165	180	CW	D	90	33	YR COM	INC	599191	599051
FG/FGN20S015	14	14	180	1500	162	180	CW	GD		33	YR133 COM VDA	INC	599237	599219
FG/FGN20S016	14	14	180	1500	165	180	CW	D	90	33	YR133 COM VDA	INC	599237	599051
FG/FGN20S017	14	14	180	1500	162	180	CW	GD		33	YR133 COM VDA	INC	599237	599219
FG/FGN20S018	14	14	180	1500	165	180	CW	D	90	33	YR133 COM VDA	INC	599237	599051
FG/FGN20S019	14	14	180	1500	165	180	CW	GD		33	YR133 COM VDA	INC	599237	599219
FG/FGN20S022	14	14	180	1500	165	180	CW	D	90	33	YR133 COM VDA	INC	599237	599051
FG/FGN23S010	14	14	230				CW	GD		33				595465
FG/FGN23S011	14	14	230				CW	G	95	33	YR COM	INC	595464	595472
FG/FGN23S012	14	14	220	1700	152	195	CW	GD		32	YR223	INC	592142	595369
FG/FGN23S013	14	14	220	1600	155	195	CW			32	YR COM VDA	INC	599127	595369
FG/FGN23S021	14	14	220	1600	155	195	CW	G	55	33	YR COM VDA	INC	599127	599070
FG/FGN23S022	14	14	230	1000	190	216	CW	G	78	17	YR223	INC	599053	595352
FG/FGN23S025	14	14	230	1250	178	232	CW	D	90	32	YR COM	INC	599062	599051
FG/FGN23S026	14	14	230	1250	178	232	CW	D	90	32	YR COM	INC	599062	599051
FG/FGN23S027	14	14	220	1500	152	195	CW	GD		33	YR208	INC	599128	595369
FG/FGN23S028	14	14	230	1250	178	232	CW	D	90	32				599051
FG/FGN23S031	14	14	230	1400	178	222	CW	D	90	32				599051
FG/FGN23S032	14	14	220	1500	178	232	CW	G	95	33	YR COM	INC	595464	595363
FG/FGN23S033	14	14	220			232	CW	G	95	33				595363
FG/FGN23S035	14	14	230	1400	178	222	CW	D	90	33	YR COM VDA	INC	599141	599051
FG/FGN23S039	14	14	220	1500	152	195	CW	G	55	32	YR COM VDA	INC	599127	599070
FG/FGN23S040	14	14	220	1500	178	232	CW	G	95	33	YR COM	INC	595464	595363
FG/FGN23S041	14	14	220				CW	G	95	33	YR COM VDA	INC	599217	595363
FG/FGN23S043	14	14	230				CW	GD		33	YR COM	INC	595464	595465
FG/FGN23S044	14	14	230	1600	158	191	CW	GD		33	YR COM	INC	599088	595465
FG/FGN23S046	14	14	230	1400	178	222	CW	D	90	32				599051
FG/FGN23S048	14	14	220	1500	152	198	CW	GD		33	YR COM VDA	INC	599300	595369
FG/FGN23S049	14	14	220	1500	155	198	CW	GD		33	YR COM VDA	INC	599300	595369
FG/FGN23S054	14	14	230	1600	158	193	CW	GD		33	YR COM	INC	595464	595465
FG/FGN23S057	14	14	230	1500	178	225	CW	D	90	33				599051
FG/FGN23S058	14	14	220	1500	178	232	CW	G	95	33	YR COM	INC	599088	595363
FG/FGN23S059	14	14	220	1500	185	232	CW	G	95	33	YR COM	INC	599261	595363
FG/FGN23S061	14	14	230	1350	178	226	CW	D	90	33	YR COM VDA	INC	599183	599051
FG/FGN23S062	14	14	220	1600	150	197	CW	G	55	33				599243
FG/FGN23S063	14	14	230	100	190	216	CW	G	80	17	YR233	INC	599210	595352
FG/FGN23S065	14	14	220	1400	178	225	CW	D	90	33	YR133 COM VDA	INC	599238	599051
FG/FGN23S066	14	14	220	1400	178	225	CW	D	90	33	YR133 COM VDA	INC	599238	599051
FG/FGN23S068	14	14	220	1500	185	232	CW	G	95	33	YR COM VDA	INC	599270	595363
FG/FGN23S073	14	14	230	1400	178	222	CW	D	90	33	YR133	INC	599294	599051
FG/FGN23S074	14	14	230	1400	178	222	CW	D	90	33	YR133	INC	599294	599051
FG/FGN23S075	14	14	230	1400	178	222	CW	D	90	33	YR133	INC	599294	599051



TC											
FG/FGN18T101	599231			595437				599252	593563 ▲	593564 ▲	593991 ▲
FG/FGN18T106	599231			599337		599338			593563 ▲	593564 ▲	595494 ▲
FG/FGN18T112	599231			599258				593832	593563 ▲	593564 ▲	595494 ▲
FG/FGN18T115	599231			595437				588016	593563 ▲	593564 ▲	593991 ▲
FG/FGN18T117	599231			599100					593563 ▲	593564 ▲	593991 ▲
FG/FGN18T118	599231			595437				588001	593563 ▲	593564 ▲	593991 ▲
FG/FGN18T119	599231			595437				599327	593563 ▲	593564 ▲	593991 ▲
FG/FGN18T120	599231			599066				599143	593563 ▲	593564 ▲	593991 ▲
FG/FGN18T121	599231			595437				595448	593563 ▲	593564 ▲	593991 ▲
FG/FGN18T122	599231			599066		599137			593563 ▲	593564 ▲	593991 ▲
FG/FGN18T123	599231			595437				599248	593563 ▲	593564 ▲	593991 ▲
FG/FGN20S011	599192			595499				599143	593563 ▲	593684 ▲	593921 ▲
FG/FGN20S014	599192			595499				599248	593563 ▲	593684 ▲	593921 ▲
FG/FGN20S015	599192			599226					593563 ▲	593684 ▲	593921 ▲
FG/FGN20S016	599192			595499				599248	593563 ▲	593684 ▲	593921 ▲
FG/FGN20S017	599192			599220				595333	593563 ▲	593684 ▲	593921 ▲
FG/FGN20S018	599192			595499				599143	593563 ▲	593684 ▲	593921 ▲
FG/FGN20S019	599192			599220				593920	593563 ▲	593684 ▲	593921 ▲
FG/FGN20S022	599192			599064				599248	593563 ▲	593684 ▲	593921 ▲
FG/FGN23S010	599120			595468		595469			593563 ▲	593684 ▲	595471
FG/FGN23S011	599120			599186					593563 ▲	593684 ▲	595471
FG/FGN23S012				599068					593563 ▲	593684 ▲	599130 ▲
FG/FGN23S013	599120			599068		595368			593563 ▲	593684 ▲	599069 ▲
FG/FGN23S021	599120			599071		595368			593563 ▲	593684 ▲	599069 ▲
FG/FGN23S022	599063			599056				599057	599058 ▲	595470 ▲	599059 ▲
FG/FGN23S025	599063			599064				595448	593563 ▲	593684 ▲	593921 ▲
FG/FGN23S026	599063			595499		595308			593563 ▲	593684 ▲	593921 ▲
FG/FGN23S027	599120			599068		595368			593563 ▲	593684 ▲	599109 ▲
FG/FGN23S028	599063			599064				595448	593563 ▲	593684 ▲	593921 ▲
FG/FGN23S031	599063			595499		595308			593563 ▲	593684 ▲	593921 ▲
FG/FGN23S032	599334			599186				599094	593563 ▲	593684 ▲	599112 ▲
FG/FGN23S033	599334			599186				599094	593563 ▲	593684 ▲	599112 ▲
FG/FGN23S035	599063			595499				599143	593563 ▲	593684 ▲	593921 ▲
FG/FGN23S039	599120			599071				599105	593563 ▲	593684 ▲	599069 ▲
FG/FGN23S040	599120			599186					593563 ▲	593684 ▲	599112 ▲
FG/FGN23S041	599334			599186					593563 ▲	593684 ▲	599112 ▲
FG/FGN23S043	599089			595468		595469			593563 ▲	593684 ▲	595471
FG/FGN23S044	599089			599090		595469			593563 ▲	595470 ▲	599091 ▲
FG/FGN23S046	599063			595499		599137			593563 ▲	593684 ▲	593921 ▲
FG/FGN23S048	599120			599068		599184			593563 ▲	593684 ▲	599130 ▲
FG/FGN23S049	599120			599068		595368			593563 ▲	593684 ▲	599069 ▲
FG/FGN23S054	599089			595468		595469			593563 ▲	595470 ▲	595471
FG/FGN23S057	599063			595499				599143	593563 ▲	593684 ▲	593921 ▲
FG/FGN23S058	599334			599186					593563 ▲	593684 ▲	599112 ▲
FG/FGN23S059	599262			599264					593563 ▲	595470 ▲	599112 ▲
FG/FGN23S061	599063			595499				599143	593563 ▲	593684 ▲	593921 ▲
FG/FGN23S062	599120			599244		599245			593563 ▲	593684 ▲	599109 ▲
FG/FGN23S063	599063			599056				599057	593563 ▲	593684 ▲	599059 ▲
FG/FGN23S065	599063			599064		599137			593563 ▲	593684 ▲	593921 ▲
FG/FGN23S066	599063			595499				599143	593563 ▲	593684 ▲	593921 ▲
FG/FGN23S068	599262			599264					593563 ▲	595470 ▲	599112 ▲
FG/FGN23S073	599063			599064				595448	593563 ▲	593684 ▲	593921 ▲
FG/FGN23S074	599063			595499		599137			593563 ▲	593684 ▲	593921 ▲
FG/FGN23S075	599063			595499				599143	593563 ▲	593684 ▲	593921 ▲

---

**NOTES NOTES NOTAS NOTAS NOTE NOTITIES NOTIZEN NOTATAKI NOT ПРИМЕЧАНИЯ POZNAMKY**

---

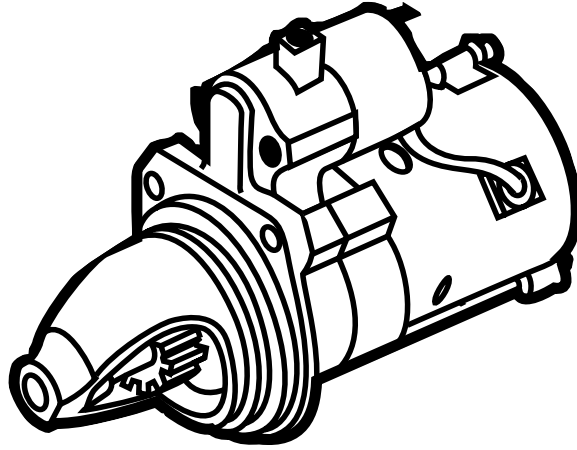

<b>D6G - D6RA</b>	
<b>D6GS - D6RAD</b>	89
<b>BD7E-D7E-D7ED</b>	
<b>D7G-D7GS-D7R-D7RS</b>	95
<b>D8R</b>	101
<b>D9E-D9R</b>	105
<b>TS8-TS10-TS12</b>	
<b>TS14-TS18</b>	
<b>TS22-TS24</b>	109
<b>FS10</b>	113
<b>D13HP</b>	117

---

**NOTES NOTES NOTAS NOTAS NOTE NOTITIES NOTIZEN NOTATAKI NOT ПРИМЕЧАНИЯ POZNAMKY**

---







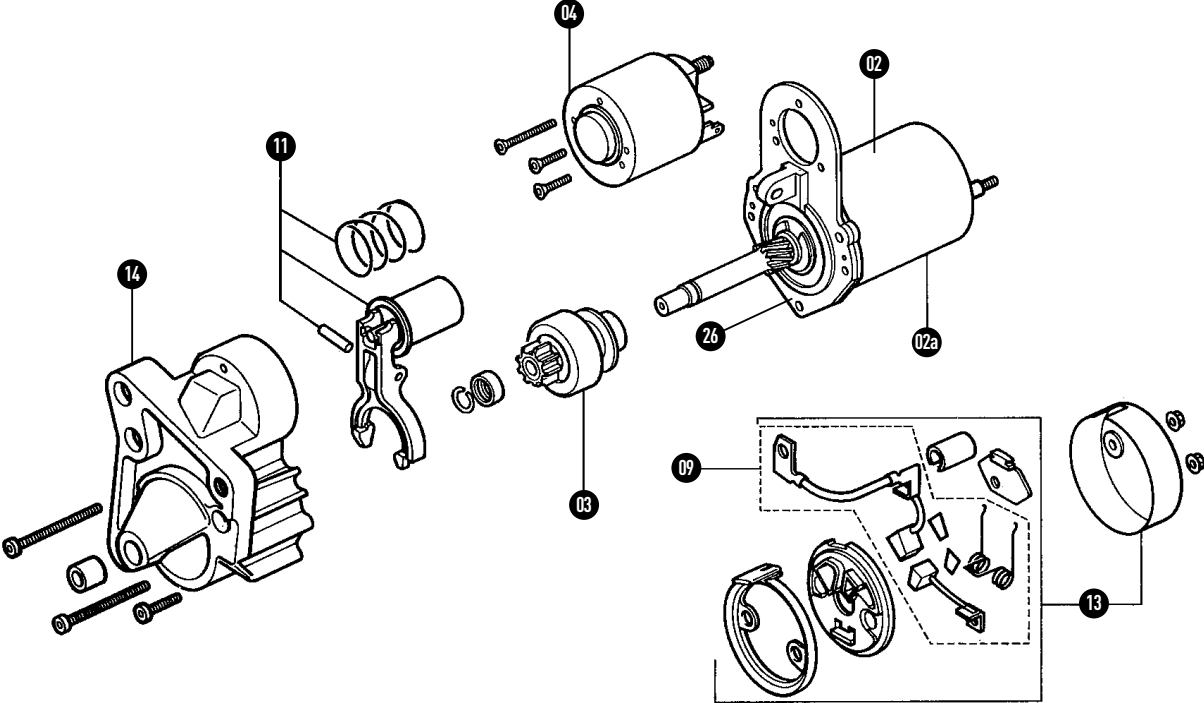

# D6G - D6RA

# 2.1

## 16 D6A - D6RAD











								 02	 02a	 03	 26
D6G1	-	12	1,3	9	CW	D	75	594650		594644	595660
D6G2	-	12	1,2	9	CCW	D	37	594650		594685	594688
D6G3	-	12	1,3	9	CW	D	55	594650		594644	595660
D6G5	-	12	1,25	9	CW	G	38	594650		594644	595722
D6G32	-	12	1,3	9	CW	D	75	594650		594644	595660
D6G33	-	12	1,2	9	CW	D	75	594650		594644	595660
D6G321	-	12	1,3	9	CW	D	75	594650		594644	595721
D6G332	-	12	1,3	9	CW	D	75	594650		594644	
D6GS11	-	12	1,1	10	CCW	G	44	595610		594665	594671
D6GS11M	-	12	1,1	10	CCW	G	42	595610		594665	594671
D6GS12	-	12	1,1	10	CCW	G	41	595610		595717	594671
D6GS12M	-	12	1,1	10	CCW	G	41	595610		595717	594671
D6GS13	-	12	1,1	10	CCW	G	41	595610		594665	594671
D6GS13M	-	12	1,1	10	CCW	G	41	595610		594665	594671
D6GS14	-	12	1,1	10	CCW	G	42	595610		594666	594672
D6GS14M	-	12	1,1	10	CCW	G	42	595610		594666	594672
D6GS19	-	12	1,1	9	CW	D	31	594650		594716	594719
D6RA5	16	12	1,2	9	CW	G	35	594526	594019	594029	594538
D6RA6	16	12	1,2	9	CW			594526	594019	594029	594538
D6RA7	16	12	1,2	9	CW				594022	594030	594536
D6RA8	16	12	1,2	9	CW			594526	594019		594538
D6RA10	16	12	1,2	9	CW			594526	594019		594538
D6RA11	16	12	1,2	9	CW			594526		594106	
D6RA12	16	12	1,2	9	CW			594526	594019	594029	594538
D6RA13	16	12	1,2	9	CW			594526	594019	594032	594538
D6RA15	16	12	1,2	9	CW	D	45	594526	594022	594033	594536
D6RA16	16	12	1,2	9	CW			594526	594019	594029	594538
D6RA17	16	12	1,2	9	CCW			594526		594034	
D6RA18	16	12	1,2	9	CW			594526	594019	594029	594538
D6RA19	16	12	1,2	9	CCW			594526		594034	
D6RA20	16	12	1,2	9	CW			594526	594019	594029	594538
D6RA21	16	12	1,2	9	CCW			594526	594024		594537
D6RA22	16	12	1,2	9	CW			594526	594019	594086	594538
D6RA23	16	12	1,2	9	CW			594526		594029	
D6RA25	16	12	1,2	9	CW	G	45	594526			
D6RA26	16	12	1,2	9	CW	G	38	594526	594019	594029	594538
D6RA27	16	12	1,2	9	CCW	G	45	594526		594034	
D6RA28	16	12	1,2	9	CW	G	45	594526			
D6RA29	16	12	1,2	9	CCW	D	45	594526		594034	
D6RA30	16	12	1,2	11	CW	G	48	594526	594019	594107	594538
D6RA32	16	12	1,1	10	CW			594526	594019	594108	594538
D6RA33	16	12	1,2	10	CW			594526	594019	594108	594538
D6RA34	16	12	1,1	9	CCW			594526		594034	
D6RA37	16	12	1,2	9	CW	G	35	594526	594019	594029	594538
D6RA38	16	12	1,2	9	CW			594526	594019	594029	594538
D6RA39	16	12	1,2	10	CW	D	45	594526	594019	594108	594538
D6RA40	16	12	1,2	9	CW	D	60	594526		594106	
D6RA41	16	12	1,2	9	CW			594526	594019	594029	594538
D6RA42	16	12	1,2	9	CCW	G	38	594526	594024	594109	594537
D6RA43	16	12	1,2	9	CCW			594526	594024		594537
D6RA44	16	12	1,2	10	CCW	G	36	594526	594024		594537
D6RA45	16	12	1,2	9	CW					594029	594539
D6RA46	16	12	1,1	10	CW			594526			
D6RA47	16	12	1,1	11	CW	D	32	594526	594022		594536
D6RA48	16	12	1,1	10	CW			594526	594019	594108	594538
D6RA49	16	12	1,2	10	CW			594526	594019	594108	594538
D6RA50	16	12	1,2	9	CCW	D	45		594150	594034	
D6RA51	16	12	1,2	9	CW					594029	594539
D6RA52	16	12	1,2	9	CW	G	40			594086	594539
D6RA53	16	12	1,05	9	CW	G	58		594176	594214	594541
D6RA54	16	12	1,2	9	CCW	D	45		594150	594034	
D6RA55	16	12	1,2	9	CCW					594172	
D6RA56	16	12	1,2	10	CW	G	32		594176	594252	594541
D6RA57	16	12	1,2	9	CW					594029	594539
D6RA59	16	12	1,2	10	CW	D	40	594526	594019	594108	594538
D6RA60	16	12	1,2	9	CCW	G	45		594150	594034	
D6RA61	16	12	1,2	10	CW	G	32	594526	594019	594108	594538

TC								
D6G1	594646	594648	594651			594645		594643
D6G2	594686	594687	594674			594645		594684
D6G3	594348	594648	594774			594645		594705
D6G5	594724	594648	594774			594645		594723
D6G32	594646	594648	594651			594645		594754
D6G33		594648	594774			594645		594754
D6G321		594648	594651			594645		
D6G332	595709	594648			595661	595662		
D6GS11	595726		594674			594667		594661
D6GS11M	595726		594674			594667		
D6GS12	595726		594674			594667		594662
D6GS12M	595726		594674			594667		
D6GS13	595726		594674			594667		594663
D6GS13M	595726		594674			594667		
D6GS14	595726		594674			594667		594664
D6GS14M	595726		594674			594667		
D6GS19	594617		594720			594667		594715
D6RA5	594045	594534		594060		594068	594070	
D6RA6	594046	594534		594060		594068	594070	
D6RA7	594045	594534				594068	594129	594556
D6RA8	594087	594534		594064		594068	594072	
D6RA10	594045	594534		594064		594068	594072	
D6RA11						594068		594558
D6RA12	594183	594534		594060		594068	594070	594584
D6RA13	594045	594534		594127		594068	594129	
D6RA15	594045	594534		594127		594068	594129	594556
D6RA16	594183	594534		594060		594068	594070	
D6RA17	594087			594127		594068	594129	
D6RA18	594087	594534		594060		594068	594070	
D6RA19	594087			594127		594068	594129	594561
D6RA20	594045	594534		594060		594068	594070	
D6RA21	594046			594127		594068	594129	594562
D6RA22	594087	594534		594127		594068	594129	594563
D6RA23	594087	594534		594127		594068	594129	
D6RA25		594534		594127		594068	594130	
D6RA26	594138	594534		594127		594068	594129	594565
D6RA27	594087			594127		594068	594129	594566
D6RA28		594534		594127		594068	594130	
D6RA29	594087			594127		594068	594129	594567
D6RA30	594138	594534		594127		594068	594129	594568
D6RA32	594117	594534		594127		594068	594130	
D6RA33	594208	594534		594169		594068	594132	594569
D6RA34	594087			594127		594068	594129	594570
D6RA37	594181	594534		594169		594068	594132	
D6RA38	594183	594534		594060		594068	594129	
D6RA39	594145	594534		594127		594068	594129	594571
D6RA40	594604	594534		594127		594068	594129	594558
D6RA41	594208	594534		594127		594068	594129	
D6RA42	594045			594127		594068	594129	
D6RA43				594127		594068	594129	
D6RA44	594087			594127		594068	594129	
D6RA45	594208	594534		594060		594068	594070	594573
D6RA46	594178	594534		594127		594068	594129	594569
D6RA47	594138	594534		594169		594068	594132	594574
D6RA48		594534		594127		594068	594130	
D6RA49		594534		594127		594068	594129	
D6RA50	594087			594127		594068	594129	594561
D6RA51	594181	594534		594169		594068	594132	594575
D6RA52	594087	594534		594127		594068	594129	594563
D6RA53	594208	594534				594068		594573
D6RA54	594087			594127		594068	594129	594570
D6RA55	594173			594127		594068	594129	594576
D6RA56	594178	594534		594127			594129	594569
D6RA57	594181	594534		594169		594068	594132	594577
D6RA59		594534		594127		594068	594129	594578
D6RA60	594087			594127		594068	594129	
D6RA61	594046	594534		594060		594068	594070	594569

TC								02	02a	03	26
D6RA62	16	12	1,1	10	CW			594526	594233	594252	594542
D6RA63	16	12	1,1	9	CW	D	40	594529		594214	594544
D6RA64	16	12	1,2	9	CW	D	46			594029	594539
D6RA65	16	12	1,3	9	CW			594526		594214	
D6RA66	16	12	1,2	9	CW					594029	594539
D6RA67	16	12	1	9	CW	D	78	594528			
D6RA68	16	12	1,3	9	CW	D	31	594526		594248	594546
D6RA70	16	12	1,3	10	CW			594529			
D6RA72	16	12	1,2	9	CW	G				594029	594539
D6RA73	16	12	1,1	10	CW			594526	594233	594252	594542
D6RA74	16	12	0,85	9	CW	G	55		594176	594214	594541
D6RA75	16	12	1,1	9	CCW					594284	594545
D6RA76	16	12	1,3	8	CW	G	54	594528	594236	594247	594543
D6RA77	16	12	0,9	8	CW	G	54	594528	594236	594247	594543
D6RA78	16	12	1,1	8	CW			594528	594236	594247	594543
D6RA79	16	12	1,1	8	CW			594528	594236	594247	594543
D6RA80	16	12	1	9	CW			594528			
D6RA81	16	12	1	9	CW			594528	594363	594361	
D6RA82	16	12	1,1	10	CW			594526		594252	
D6RA83	16	12	1,1	10	CW	G	38	594529	594402	594252	594551
D6RA84	16	12	1,3	9	CW			594529		594214	594609
D6RA85	16	12	1,3	9	CW			594529		594214	594609
D6RA87	16	12	1,3	9	CW	D	33	594529	594409	594214	594609
D6RA91	16	12	1	9	CW	G	53	594528			
D6RA93	16	12	1,3	10	CW	G	75	594526	594233	594252	594542
D6RA100	16	12	1,4	10	CW	D	55	594530	594412	594252	594549
D6RA101	16	12	1,4	11	CW			594530	594384	594382	594543
D6RA104	16	12	1,4	11	CW	G	32	594530	594384	594382	594543
D6RA105	16	12	1,3	11	CW	D	56	594530	594384	594382	594543
D6RA107	16	12	1,3	10	CW	GD		594530	594412	594252	594543
D6RA108	16	12	1,3	9	CW	D	31	594530			594549
D6RA109	16	12	1,4	10	CW	G	55	594530	594412	594252	594549
D6RA110	16	12	1,4	11	CW	G	37	594530	594448	594382	594554
D6RA114	16	12	1,4	10	CW	G	55	594530	594384	594252	594543
D6RA115	16	12	1,3	11	CW	D	56	594530	594384	594382	594543
D6RA133	16	12	1,2	10	CW	G	32	594526	594233	594252	594542
D6RA137	16	12	1,3	9	CW	D	33	594529		594214	594544
D6RA138	16	12	1,3	9	CW	D	33	594529	594176	594214	594541
D6RA141	16	12	1,3	9	CW	G	30		594176	594214	594541
D6RA146	16	12	1,4	10	CW	D	35	594529			
D6RA161	16	12	1	9	CW				594176	594214	594541
D6RA162	16	12	1,1	10	CW	G	75	594526	594233	594252	594542
D6RA163	16	12	1,1	10	CW	G	75	594529	594176	594252	594541
D6RA165	16	12	1,3	9	CW			594526		594214	
D6RA167	16	12	1	9	CW	D	78	594528			
D6RA168	16	12	1,3	9	CW	D	31	594529		594248	594548
D6RA169	16	12	1,1	10	CW	G	75	594529	594176	594252	594541
D6RA180	16	12	1	9	CW	D	50	594528			
D6RA181	16	12	1	9	CW	G	58	594528	594363	594361	
D6RA185	16	12	1,3	9	CW			594529		594214	594609
D6RA187	16	12	1,3	9	CW	D	33	594529	594440	594214	594609
D6RA188	16	12	1,3	9	CW	D	33	594529	594440	594214	594609
D6RA190	16	12	1,4	9	CW	G	55	594528		594214	594543
D6RA210	16	12	1,2	9	CCW	D	40				594552
D6RA249	16	12	1,1	10	CW	G	75	594526	594233	594252	594542
D6RA293	16	12	1,3	10	CW	G	75	594529	594176	594252	594541
D6RA39	16	12	1,2	10	CW	D	45	594526	594019	594108	594538
D6RA421	16	12	1,2	9	CCW	G	38	594529		594755	594552
D6RA431	16	12	1,2	9	CCW	G	36	594529		594757	594552
D6RA441	16	12	1,2	10	CCW	G	36	594529		594758	594552
D6RA511	16	12	1	9	CW	D	55		594176	594214	594541
D6RA571	16	12	1,2	9	CW	G	35		594176	594214	594541
D6RA572	16	12	1,2	9	CW	G	35		594176	594214	594541
D6RA661	16	12	1	9	CW	G	55		594176	594214	594541
D6RA721	16	12	1,2	9	CW			594529	594237	594214	594547
D6RA811	16	12	1,1	9	CW	G	58	594530		594361	594772
D6RAD183	16	12	1,3	10	CW	G	37	594529	594402	594252	594551



TC								
D6RA62	594117	594534		594264			594263	594579
D6RA63	594208	594534		594127			594129	
D6RA64	594087	594534		594258		594068		
D6RA65		594534					594605	
D6RA66	594183	594534		594127		594068	594129	
D6RA67	594357			594317		594255	594318	
D6RA68	594271	594534		594261		594259	594260	
D6RA70	594188	594534		594127		594374	594129	594598
D6RA72	594183	594534		594127		594068	594129	594584
D6RA73		594534		594060				594569
D6RA74	594183	594534		594258			594418	594585
D6RA75	594173			594127			594387	594576
D6RA76	594269	594534		594258			594257	594586
D6RA77	594269	594534		594258			594257	
D6RA78		594534		594317			594323	
D6RA79		594534		594317			594323	
D6RA80	594357			594360				
D6RA81				594360				
D6RA82	594117	594534		594312			594311	
D6RA83	594401	594534		594404				594592
D6RA84	594607	594534		594437			594608	594606
D6RA85		594534		594366			594605	594606
D6RA87	594414	594534		594377			594416	594593
D6RA91				594360				594594
D6RA93	594636	594534		594317		594374	594637	594579
D6RA100	594426	594535		594423		594068	594424	594595
D6RA101		594535		594386			594385	594596
D6RA104	594383	594535		594386			594385	594596
D6RA105	594411	594535		594443			594442	594597
D6RA107	594188	594535		594423			594424	594598
D6RA108	594428	594535		594430		594068	594429	
D6RA109	594188	594535		594423			594424	594600
D6RA110	594449	594535		594386			594385	594601
D6RA114	594188	594535		594423			594424	594740
D6RA115	594411	594535		594443			594464	594597
D6RA133	594208	594534		594169			594132	594569
D6RA137	594414						594416	594603
D6RA138	594414	594534		594377			594416	594689
D6RA141	594208	594534		594127			594129	
D6RA146				594060			594070	
D6RA161	594183	594534						
D6RA162	594117	594534		594377		594374	594376	594579
D6RA163	594117	594534		594317		594374	594637	594579
D6RA165	594414	594534		594366		594555	594605	594606
D6RA167				594317			594318	
D6RA168	594271	594534		594261		594259	594260	
D6RA169	594117	594534		594317		594374	594637	594579
D6RA180				594360				
D6RA181				594360				
D6RA185	594414	594534		594366			594605	594606
D6RA187	594414							594603
D6RA188	594414							594689
D6RA190	594188	594535		594423			594424	594770
D6RA210	594178			594437			594434	594562
D6RA249	594117	594534		594377		594374	594376	594579
D6RA293	594636	594534		594317		594374	594637	594579
D6RA39	594145	594534		594127		594068	594129	594571
D6RA421	594269			594127			594129	594552
D6RA431				594127			594129	594552
D6RA441	594087			594127			594129	594552
D6RA511	594181	594534		594169			594132	594575
D6RA571	594181	594534		594169			594132	594577
D6RA572	594365	594534		594366			594367	594577
D6RA661	594183	594534		594127			594129	
D6RA721	594183	594534		594127			594129	594584
D6RA811	594145	594535		594317			594771	
D6RAD183		594534		594404		594460		594592

---

**NOTES NOTES NOTAS NOTAS NOTE NOTITIES NOTIZEN NOTATAKI NOT ПРИМЕЧАНИЯ POZNAMKY**

---

# BD7E - D7E - D7ED D7G - D7GS - D7R - D7RS

# 2.2



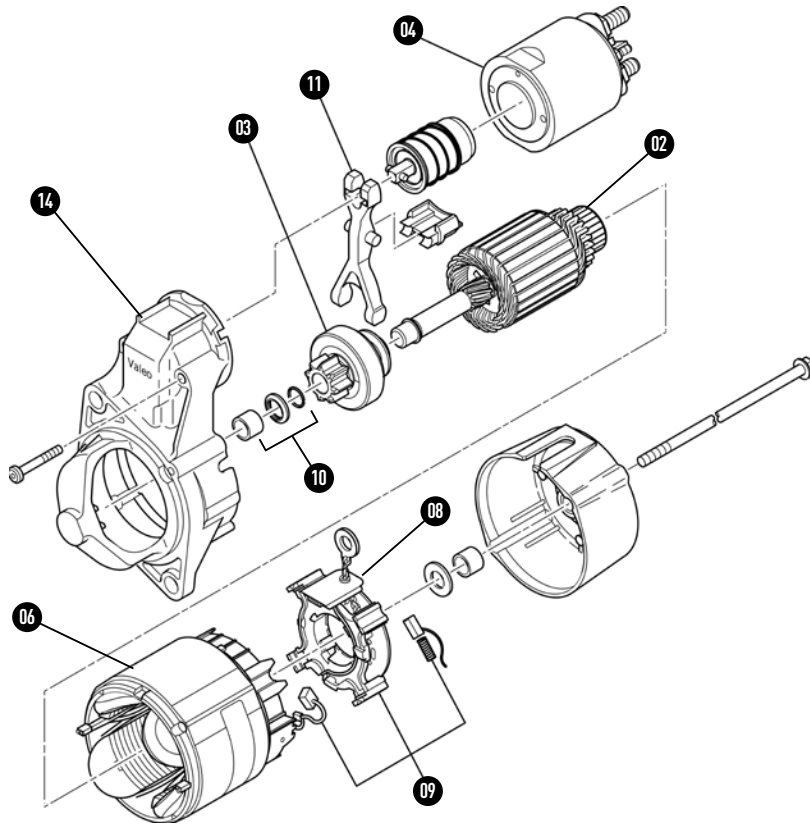

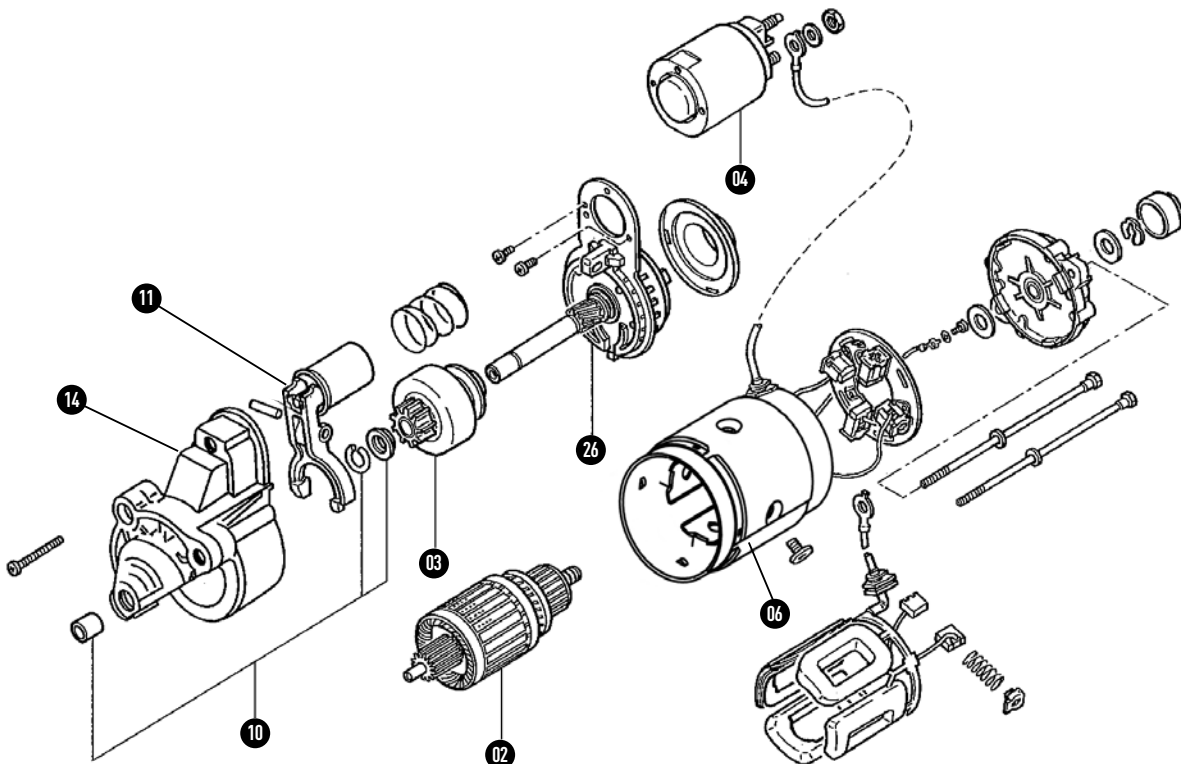

## 17 BD7E - D7E - D7ED









## 18 D7G - D7GS - D7R - D7RS



TC			KW						02		03		26
BD7E17	17	12	1,2	8	CW	G	75			555532			
BD7E44	17	12								555532			
D7E1	17	12	0,85	9	CW	D	37	594518		594287			
D7E4	17	12	1	8	CW			594519		594345			
D7E5	17	12	0,85	9	CW								
D7E6	17	12	0,85	8	CW			594519		594345			
D7E8	17	12	1	8	CW	G	32	594519		594345			
D7E11	17	12	0,85	8	CW	G	46	555541		555533			
D7E15	17	12	0,85	8	CW	G	38	594519		594345			
D7E16	17	12	0,8	9	CW	D	55	594518		594287			
D7E18	17	12	1	8	CW	G	32	594519		594345			
D7E19	17	12	0,85	8	CW	D	50	594518		594436			
D7E20	17	12	0,85	8	CW	G	38	594518		594436			
D7E22	17	12	0,85	8	CW	D	50	594518		594436			
D7E23	17	12	0,85	9	CW	D	55	594518		594287			
D7E26	17	12	0,75	9	CW	D	50	594518		594287			
D7E27	17	12	0,85	8	CW	D	50	594518		594436			
D7E29	17	12	0,7	8	CW	D	35	594519		594451			
D7E30	17	12	0,7	8	CW	D	35	594519		594451			
D7E31	17	12	0,7	8	CW	G	54	594519		594451			
D7E32	17	12	0,7	8	CW	D	35	594519		594451			
D7E33	17	12	0,8	9	CW	G	24	555544		555536			
D7E34	17	12	0,7	9	CW	G	24			555536			
D7E35	17	12						556554		555535			
D7E36	17	12						556554		555535			
D7E37	17	12	1	9	CW	G	24	555544		555536			
D7E38	17	12	1	8	CW	G	32	594518		594436			
D7E39	17	12	0,85	9	CW	D	37	594518		594287			
D7E40	17	12	0,7	8	CW	D	35	594518		595733			
D7E41	17	12	0,7	8	CW	G	54	594518		595733			
D7E42	17	12	0,7	8	CW	D	35	594518		595733			
D7E43	17	12	0,9	9	CW	G	24	555544		555536			
D7E47	17	12	0,85	8	CW	D	50	594518		594436			
D7E52	17	12	0,9	9	CW	G	47	594518		594287			
D7E6	17	12	0,85	8	CW			594519		594345			
D7E62	17	12	0,8	9	CW	G	70	594518		594287			
D7E70	17	12	0,8	9	CW	G	48	594518		594760			
D7E79	17	12	0,8	9	CW	D	45	594518		594287			
D7ED28	17	12	0,8	8	CW	G	32	594519		594345			
D7ED281	17	12	0,8	8	CW	G	32	594518		594436			
D7ES6	17	12	0,9	9	CCW	G	40	555542		555534			
D7G3	18	12	1,5	11	CW	G	37	594621		594631			
D7G4	18	12	1,6	10	CW	GD	90	594621		594465			
D7G6	18	12	1,7	9	CW	G	27	594621					
D7G11	18	12	2	10	CW	D	32	594621		594657			
D7G11(B)	18	12	2	10	CW			594621		594657			
D7G13	18	12	1,5	10	CW	GD	90	594621		594465			
D7G14	18	12	2,2	10	CW	G	25	594683		594729		594732	
D7G15	18	12	2,2	10	CW	D	25	594683		594729		594732	
D7G18	18	12	2,2	10	CW	D	25	594683		594729		594732	
D7G26	18	12	2,2	11	CW	G	38	594683		594631		594709	
D7GS7	18	12	1,7	9	CW	G	39	594621		594640			
D7GS8	18	12	2	11	CCW	G	45	594683		594677		594681	
D7GS9	18	12	1,7	9	CW	G	54	594781		594640		594694	
D7GS10	18	12	2	11	CCW	G	48	594683		594678		594682	
D7GS17	18	12	1,7	9	CW	G	27	594621		594640			
D7R7	18	12	1,6	10	CW	G	58	594112		594185		594141	
D7R1	18	12	1,4	10	CW			594112		594136		594141	
D7R2	18	12	1,4	10	CW			594112		594136		594141	
D7R3	18	12	1,4	10	CW			594112		594136		594141	
D7R4	18	12	1,4	10	CW			594112		594136		594141	
D7R5	18	12	1,7	11	CW			594112		594185		594141	
D7R7	18	12	1,6	10	CW	G	58	594112		594185		594141	
D7R8	18	12	1,4	11	CW			594112		594185		594187	
D7R9	18	12	1,7	11	CW			594112		594185		594187	
D7R11	18	12	1,4	10	CW			594112		594136		594187	
D7R12	18	12	1,7	11	CW			594112		594185		594187	

TC	 04	 06	 08	 09	 10	 11	 14
BD7E17	555525		555647			555644	
BD7E44			555647				
D7E1	594288	594522	594290		594456	594289	594506
D7E4	594447	594477	594351		594457		
D7E5	594348						
D7E6	594355	594477	594351		594457	594289	594510
D7E8	594447	594477	594351		594457		
D7E11	555524		555647			555644	555554
D7E15	594407	594477	594351		594457	594289	594509
D7E16	594348	594522	594290		594456	594289	594507
D7E18	594421	594477	594351		594457	594417	
D7E19	594438	594477	594351		594457	594289	594510
D7E20	594407	594477	594351		594457	594289	594509
D7E22	594355	594477	594351		594457	594289	594510
D7E23	594348	594477	594351		594457	594289	555560
D7E26	594438			594450	594456	594289	594511
D7E27	594653	594477	594351		594457	594289	594510
D7E29	594452	594522	594290		594456	594289	594512
D7E30	594452	594522	594290		594456	594289	
D7E31	594452	594522	594290		594456	594289	
D7E32	594481	594522	594290		594456	594289	
D7E33	555527		555645			555644	555557
D7E34	555527		555550			555644	555553
D7E35			555645			555644	
D7E36	555529		555645			555644	
D7E37	555527		555645			555644	555553
D7E38	594727	594477	594351		594457	594289	
D7E39		594522	594290		594456	594289	594506
D7E40	594452	594522	594290		594456	594289	594697
D7E41	594452	594522	594290		594456	594289	
D7E42	594481	594522	594290		594457	594289	
D7E43	555527		555647			555644	555557
D7E47	594653	594477	594351		594457	594289	594510
D7E52	594459	594477	594351		594457	594289	594514
D7E6	594355	594477	594351		594457	594289	594510
D7E62	594763	594478	594479		594457	594289	594764
D7E70	594761	594477	594351		594457	594289	594762
D7E79	594765	594478	594479		594457	594289	594766
D7ED28		594477	594351		594457		
D7ED281		594477	594351		594457		
D7ES6	555526	555538	555649			556551	555556
D7G3	595731					594466	594630
D7G4	594467	594469				594466	594504
D7G6	595617	594619				594616	594614
D7G11	594658					594466	594656
D7G11(B)	594658				594752	594466	594656
D7G13	594454	594469				594616	594713
D7G14	594731	594708				594730	594728
D7G15	594739	594708				594730	594737
D7G18	594738	594708				594730	594737
D7G26	595731	594708				594710	594707
D7GS7	594624	594619				594616	
D7GS8	594617					594679	594675
D7GS9	594617	594619				594616	594691
D7GS10	594617	595623				594679	594676
D7GS17	594624	594619				594616	594639
D7R7	594045	594115				594262	594485
D7R1	594426	594115				594262	
D7R2		594115				594262	
D7R3	594426	594115				594262	
D7R4		594115				594262	
D7R5	594186	594115				594262	594484
D7R7	594045	594115				594262	594485
D7R8	594188	594115				594262	
D7R9	594188	594190				594262	
D7R11	594426	594115				594262	
D7R12	594188					594262	594487

D7R13	18	12	1,6	11	CW			594112	594185	594187
D7R14	18	12	2,5	10	CW			594112	594308	594307
D7R15	18	12	1,7	10	CW			594112	594136	594187
D7R16	18	12	1,7	11	CW			594112	594185	594187
D7R17	18	12	1,5	10	CW			594112	594303	594283
D7R18	18	12	1,7	11	CW			594112	594185	594187
D7R19	18	12	2	11	CW			594112	594279	594283
D7R20	18	12	1,7	11	CW			594112	594185	594187
D7R22	18	12	2,2	10	CW			594112	594324	594283
D7R23	18	12	2,4	10	CW			594112	594324	594283
D7R24	18	12	1,4	10	CW			594112	594136	594187
D7R25	18	12	1,7	11	CW			594112	594185	594187
D7R26	18	12	1,4	11	CW	D	34	594112	594185	594187
D7R27	18	12	1,7	11	CW	D	34	594112	594185	594187
D7R28	18	12	2,2	11	CW			594112	594279	594283
D7R33	18	12	2	10	CW			594112	594136	
D7R34	18	12	2	10	CW	D	32	594112	594410	594187
D7R35	18	12	2	11	CW	G	32	594112	594185	594187
D7R36	18	12	2,2	10	CW	GD		594112		
D7R37	18	12	2,2	10	CW	GD		594112		
D7R39	18	12	2,4	9	CW	G	52	594112	594628	594307
D7R40	18	12	2	11	CW	G	27	594112	594185	594187
D7R41	18	12	2,5	9	CW	D	36	594112	594628	594307
D7R42	18	12	1,6	10	CW	G	58	594112	594303	594283
D7R43	18	12	2,2	11	CW	D	30	594112	594185	594187
D7R44	18	12	1,9	11	CW	D	56	594112	594185	594187
D7R44(C)	18	12	1,9	11	CW			594112	595669	
D7R46	18	12	2,2	11	CW	D	32	594112	594702	594187
D7R47	18	12	2,1	11	CW	D	56	594112	594185	594187
D7R48	18	12	2,1	11	CW	D	56	594112	594185	594187
D7R49	18	12	2,1	11	CW	D	56	594112	594185	594187
D7R49(C)	18	12	2,1	11				594112	595669	
D7R53	18	12	2,2	10	CW	D	32	594112	594410	594187
D7R53d	18	12	2,2	10	CW	D	32	594112	594410	
D7R56	18	12	2,2	10	CW	D	32	594112	594410	594187
D7R57	18	12	2,1	10	CW	G	56	594112	594410	594187
D7R61	18	12	2,5	9	CW	D	35	594112	594628	594307
D7R64	18	12	2,2	10	CW	G	48	594112	594136	594187
D7R65	18	12	2,2	11	CW	D	32	594112	594185	594187
D7R70	18	12	2,2	13	CW	D	35	594112		594187
D7R151	18	12	1,7	10	CW	D	55	594112	594136	594187
D7R281	18	12	2,2	11	CW	D	30	594112	594279	594283
D7RS29	18	12	2	11	CCW	G	40	594112	594699	
D7RS30	18	12	2	11	CCW	G	42	594112	594699	
D7RS31	18	12	2	11	CCW	GD	6063	594112	594699	
D7RS50	18	12	2	11	CCW	G	42	594112	594700	
D7RS129	18	12	2	11	CCW	G	40	594112	594699	
D7RS130	18	12	2	11	CCW	G	42	594112	594699	
D7RS131	18	12	2	11	CCW	GD	6063	594112	594699	
D7RS150	18	12	2	11	CCW	G	42	594112	594700	
D7RS291	18	12	2	11	CCW	GD	42	594112	594699	
D7RS301	18	12	2	11	CCW	GD	45	594112	594699	

TC	 04	 06	 08	 09	 10	 11	 14
D7R13	594275	594115				594262	
D7R14	594309					594262	594489
D7R15	594426	594115				594262	
D7R16		594115				594262	
D7R17	594188	594115					594491
D7R18	594267					594262	
D7R19	594271					594281	
D7R20	594188	594353				594262	594487
D7R22	594325	594326				594262	594493
D7R23	594325	594326				594262	594494
D7R24	594188	594115				594262	594487
D7R25	594267	594115				594262	
D7R26	594613	594115				594262	594487
D7R27	594613					594262	594487
D7R28	594271	594354				594281	
D7R33	594370					594369	
D7R34	594188	594115				594262	594494
D7R35	594388	594115				594262	
D7R36		594354					
D7R37	594482	594354					594499
D7R39	594309					594629	594627
D7R40	594383	594115				594262	594497
D7R41	594045					594262	594701
D7R42	594045	594115					594485
D7R43	594271	594354				594281	
D7R44	594411	594115				594262	594498
D7R44(C)	594638	595670					
D7R46	594271	594354					
D7R47	594411	594326				594262	594498
D7R48	594431	594432				594262	594498
D7R49	594411	594439				594262	594498
D7R49(C)	594411	594654					
D7R53	594188	594439				594262	594494
D7R53d	595664	594439					
D7R56	594188	594439				594262	594494
D7R57	594188					594262	594487
D7R61	594045					594262	594655
D7R64	594742	594354				594390	594741
D7R65	594271	594354				594369	
D7R70		594354				594281	
D7R151	594426	594115				594262	
D7R281	594271	594354				594281	
D7RS29	594391	594394				594390	594500
D7RS30	594391	594394				594390	594501
D7RS31	594392	594394				594473	594502
D7RS50	594474	594394				594473	594503
D7RS129	594391	594394				594390	594500
D7RS130	594391	594394				594390	594501
D7RS131	594392	594394				594390	594502
D7RS150	594474	594394				594473	594503
D7RS291	594391	594394				594390	594500
D7RS301	594391	594394				594390	594501

---

**NOTES NOTES NOTAS NOTAS NOTE NOTITIES NOTIZEN NOTATAKI NOT ПРИМЕЧАНИЯ POZNAMKY**





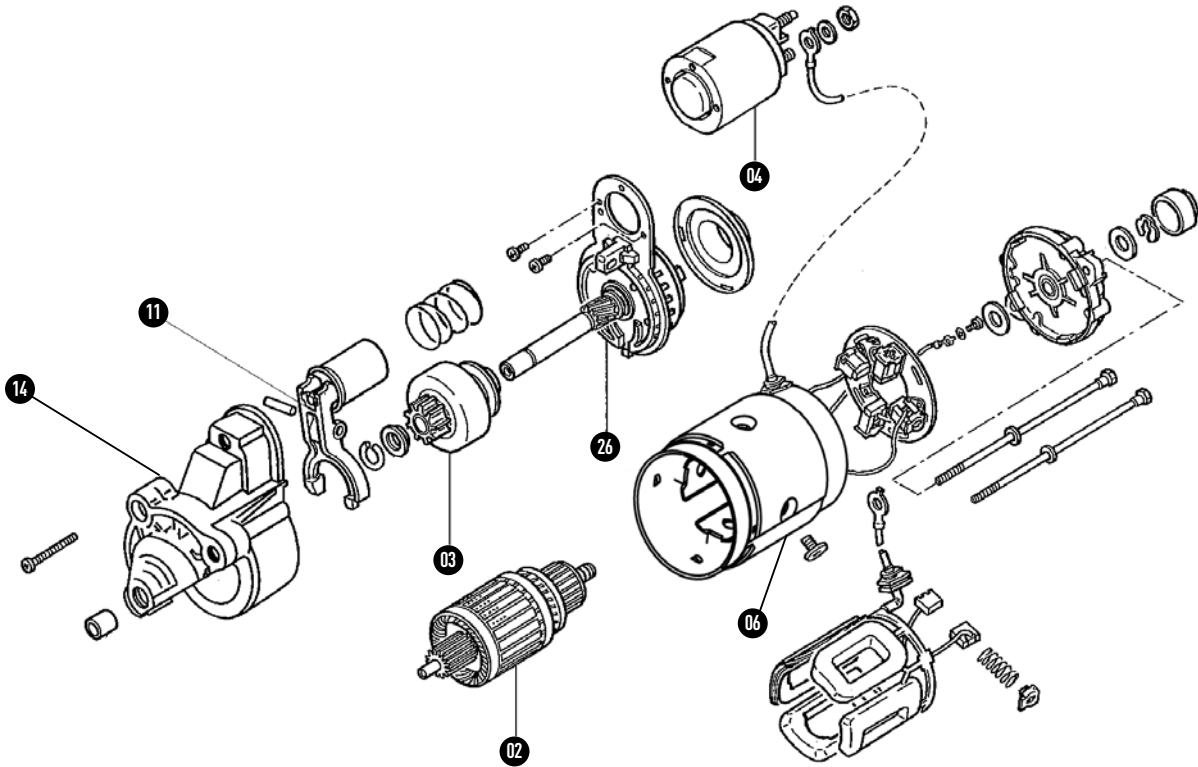

---



## 19 D8R



D8R1		19	12	2,4	10	CW	D	32	<b>594112</b>	
D8R1(c)		19	12	2,4	10	CW			<b>594112</b>	
D8R27		19	12	1,9	11	CW	G	56	<b>594112</b>	
D8R28		19	12	2,5	11	CW	G	56	<b>594112</b>	
D8R29		19	12	1,9	11	CW	G	56	<b>594112</b>	
D8R39		19	12	2,7	9	CW	G	52	<b>594112</b>	
D8R49		19	12	2,4	11	CW	D	56	<b>594112</b>	
D8R49(D)		19	12	2,4	11	CW			<b>594112</b>	

	 03	 26	 04	 06	 11	 14
D8R1	594410	594187	594188	594641	594262	594494
D8R1(c)	594410		595664	594641		
D8R27	594185	594187	594613	594641	594262	594487
D8R28	594185	594187	594613	594641	594262	594745
D8R29	594185	594187	594613	594641	594262	594733
D8R39	594628	594307	594768	594641	594629	594627
D8R49	594185	594187	594411	594746	594262	594498
D8R49(D)	595669		594411	594746		

---

**NOTES NOTES NOTAS NOTAS NOTE NOTITIES NOTIZEN NOTATAKI NOT ПРИМЕЧАНИЯ POZNAMKY**

---

# D9E - D9R

# 2.4



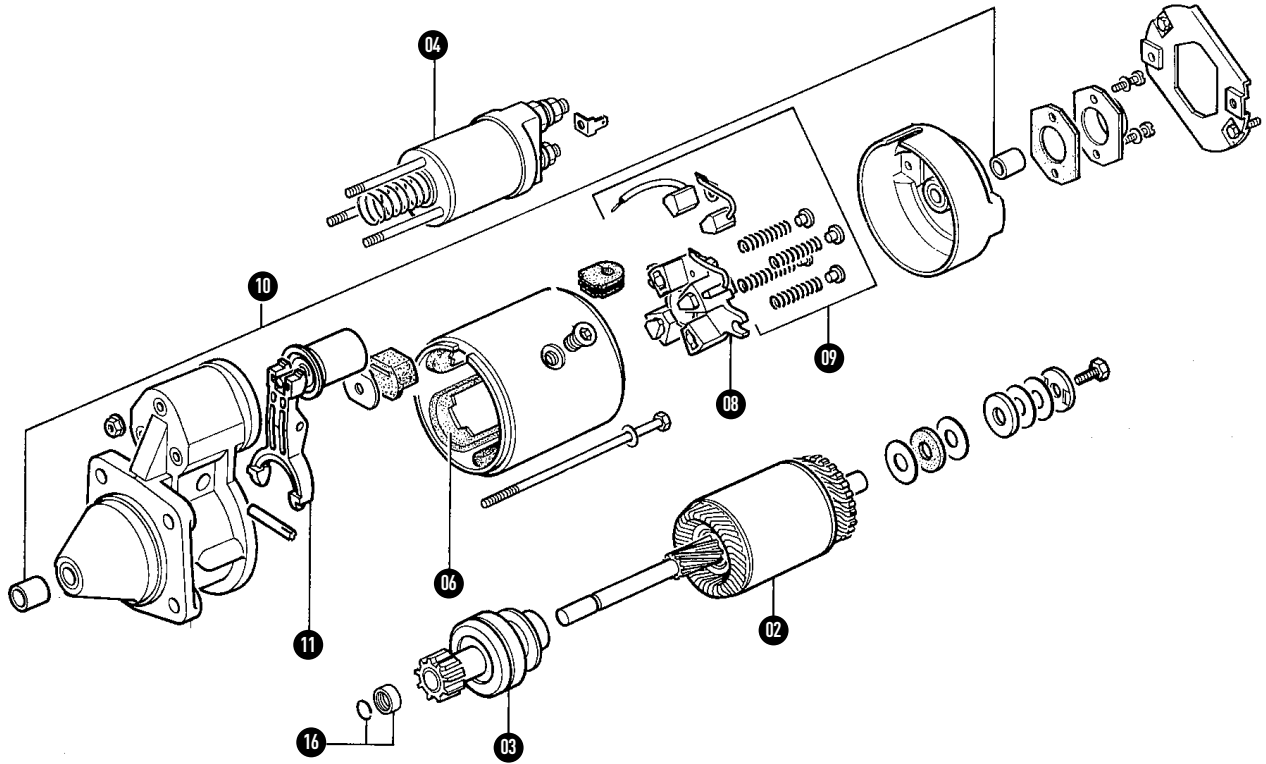

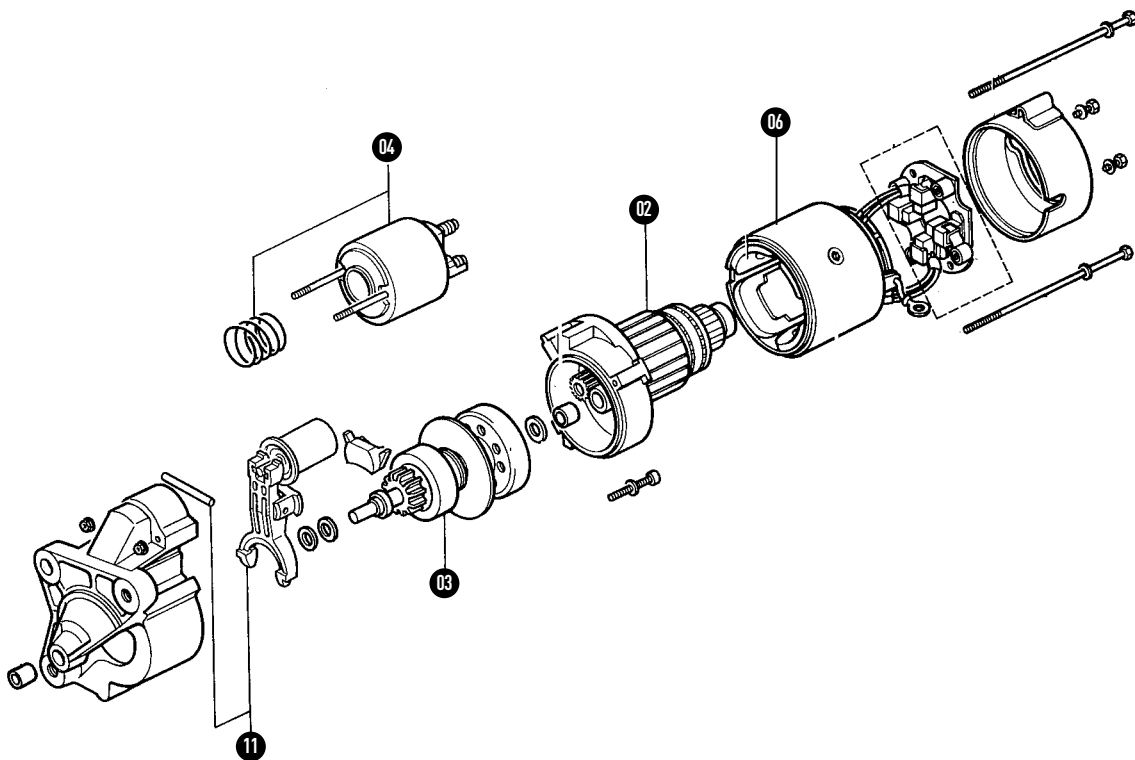

## 20 D9E



## 21 D9R



							 02	 03	 04
D9E20	20	12	1,15	9	CW				
D9E31	20	12	1,05	9	CW				594142
D9E32	20	12	1,2	9	CW				594142
D9E36	20	12	1,05	9	CW				182464
D9E38	20	12	1,05	9	CW				
D9E39	20	12	1,05	9	CW		102380	99931	182459
D9E43	20	12	1,05	9	CW			101292	594142
D9E44	20	12	1,2	9	CW			101292	594142
D9E54	20	12	1,2	9	CW				182464
D9E55	20	12	1,2	9	CW		102380	99931	
D9E57	20	12	1,05	9	CCW			102846	182461
D9E61	20	12	1,05	9	CW		102380	99931	182461
D9E62	20	12	1,2	9	CW	D	102380	99931	182461
D9E64	20	12	1,05	9	CW	G	101923	106009	182461
D9E70	20	12	1,05	9	CW		102380	99931	182461
D9E76	20	12	1,05	9	CW		102380	99931	182459
D9E78	20	12	1,05	9	CW		102380	99931	182463
D9E82	20	12	1,05	9	CW				594142
D9E83	20	12	1,05	9	CW			101292	594142
D9E85	20	12	1,2	9	CW		102380	99931	182461
D9E86	20	12	1,05	9	CW		102380	99931	182461
D9E102	20	12	1,2	9	CW	D			
D9E103	20	24	1,05	9	CCW				
D9E104	20	12	1,2	9	CCW				
D9E111	20	12	1,2	9	CCW				
D9E130	20	24	1,4	9	CCW				
D9E131	20	12	1,2	9	CW			101292	594142
D9E132	20	12	1,05	9	CW			101292	594142
D9E136	20	12	1,05	9	CW			99931	
D9E137	20	12	1,05	9	CW		102380	99931	182459
D9E138	20	12	1,2	9	CW		102380	99931	182459
D9E140	20	12	1,2	9	CCW				
D9E238	20	12	1,2	9	CW		102380	99931	
D9E701	20	12	1,05	9	CW	G	102380	99931	182461
D9E771	20	12	1,2	9	CW	G	102380	99931	182459
D9E772	20	12	1,2	9	CW	G			35
D9E773	20	12	1,2	9	CW	G			35
D9E774	20	12	1,2	9	CW	G			35
D9E776	20	12	1,2	9	CW				
D9E851	20	12	1,2	9	CW		102380	99931	182461
D9E852	20	12	1,2	9	CW		102380	99931	182461
D9E861	20	12	1,05	9	CW		102380	99931	182461
D9R73	21	12	3,1	12	CW			182047	105489
D9R84	21	12	2	10	CW			182052	105489
D9R89	21	12	3,1	11	CW		182175	182176	105489
D9R90	21	12	3,1	11	CW		182175	182177	181404
D9R91	21	12	3,1	9	CW		182175	182178	181069
D9R96	21	12	3,1	12	CW		182175		181404
D9R97	21	12	3,1	11	CCW		182175	594039	181404
D9R99	21	12	3,1	11	CW		182175	182176	105489
D9R105	21	12	3,1	9	CW		182175	594040	105489
D9R1050	21	12	3,1	9	CW		182175	594040	105489
D9R106	21	12	3,1	9	CW		182175		105489
D9R112	21	12	3,1	11	CW			182176	594053
D9R116	21	12	3,1	11	CW		182175	594043	594054
D9R118	21	12	3,1	11	CW		182175	182176	105489
D9R119	21	12	2,2	11	CW		182175	594152	
D9R121	21	12	2	10	CW	G		182052	594098
D9R122	21	12	2,1	11	CW	G	182175	182176	594098
D9R126	21	12	3,1	11	CW		182175		181069
D9R134	21	12	2,2	12	CW			594245	
D9R135	21	12	2	11	CW		182175	182176	105489
D9R139	21	12	2,2	11	CW				
D9R142	21	12	2,2	10	CW			594251	105489
D9R144	21	12	3,1	11	CW		182175	594043	594054
D9R149	21	12	2,2	11	CW		182175	594152	594266

TC	 06	 08	 09	 10	 11	 16
D9E20						73294
D9E31						
D9E32						
D9E36			182066			
D9E38			182066			
D9E39	101582		594066	182063	182058	97804
D9E43						
D9E44						
D9E54						
D9E55			182065	182063	182058	97804
D9E57			594066	182063	182058	97804
D9E61	101582	594793	594066	182063	182058	97804
D9E62			182065	182063	182058	97804
D9E64	101582		594066	182063	182058	97804
D9E70	101582		594066	182063	182058	97804
D9E76	101582		594066	182063	182058	97804
D9E78	101582		594066	182063	182058	97804
D9E82						
D9E83						
D9E85			182065	182063	182058	97804
D9E86	101582		594066	182063	182058	97804
D9E102			594065			
D9E103				182063	182058	97804
D9E104			594065			
D9E111			594065			
D9E130				182063	182058	97804
D9E131						
D9E132						
D9E136	101582		594066	182063	182058	97804
D9E137			594066	182063	182058	97804
D9E138			182065	182063	182058	97804
D9E140			182065	182063	182058	97804
D9E238			182065	182063	182058	97804
D9E701	101582		594066	182063	182058	97804
D9E771			182065	182063	182058	97804
D9E772			594065			
D9E773			594065			
D9E774			594065			
D9E776			594065			
D9E851			182065	182063	182058	97804
D9E852			182065	182063	182058	97804
D9E861	101582		594066	182063	182058	97804
D9R73	182051				182048	
D9R84					182048	
D9R89	182051				182048	
D9R90	182051				182048	
D9R91	182051				182048	
D9R96	182051				182048	
D9R97					182048	
D9R99	182051				182048	
D9R105	182051				182048	
D9R1050	182051				182048	
D9R106	182051				182048	
D9R112					594069	
D9R116	594059				182048	
D9R118	182051				182048	
D9R119	594157				182048	
D9R121					182048	
D9R122	182051				182048	
D9R126	182051				182048	
D9R134					594069	
D9R135	182051				182048	
D9R139	182051				182048	
D9R142	182051				594069	
D9R144	594059				182048	
D9R149	594157				182048	







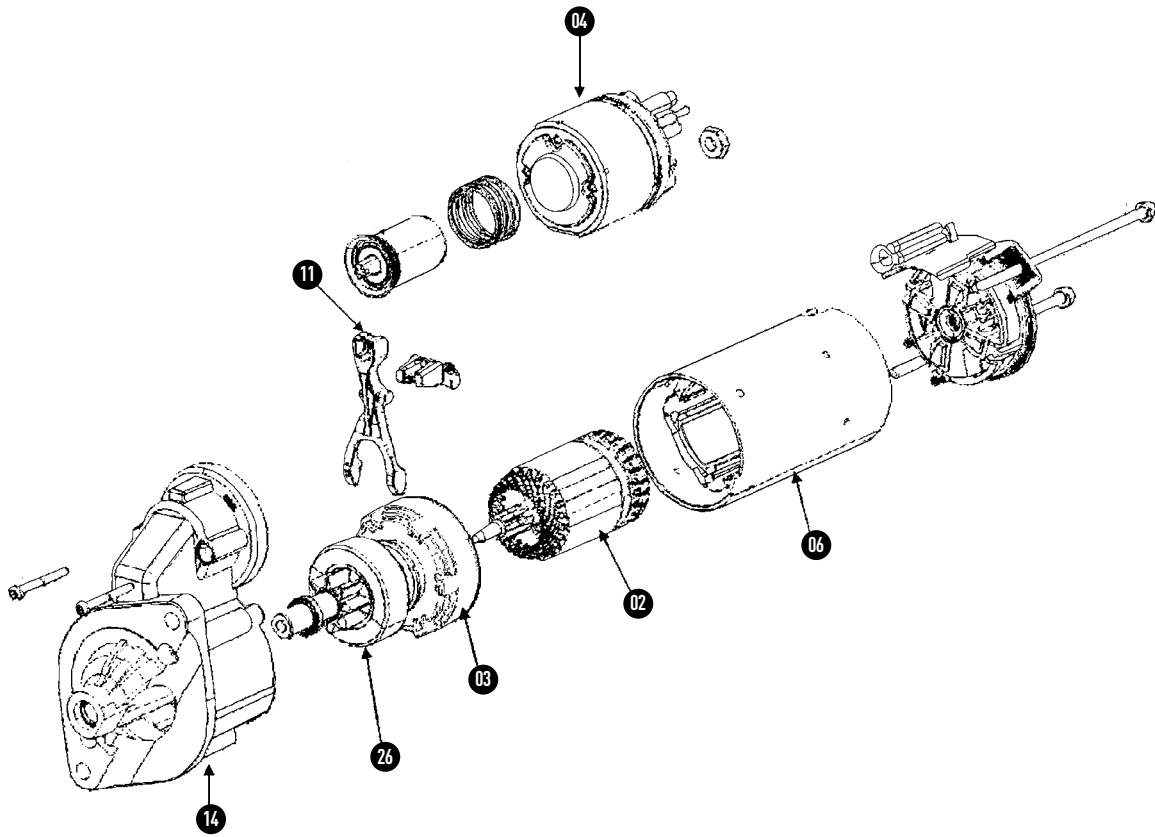



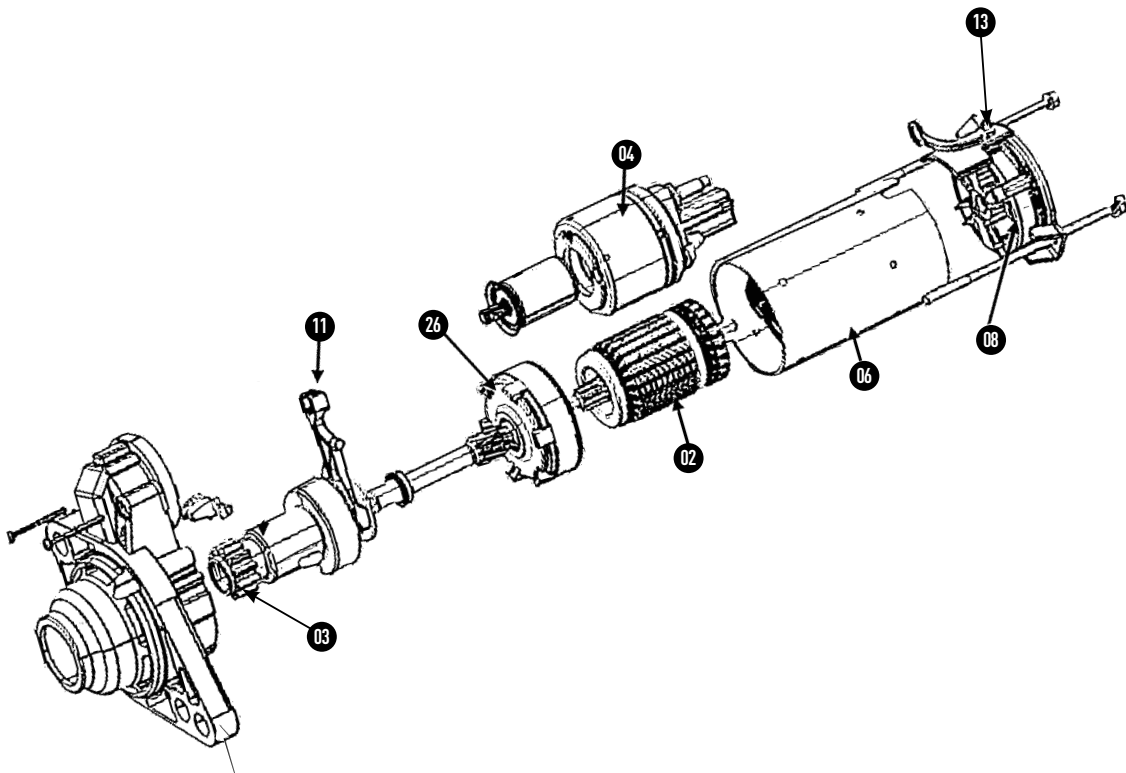

## 22 TS/E



## 23 TS/ER



TC			KW						02		03		26
TS8E2	22	12	0,8	9	CW	D	55	594721	594726				
TS8E3	22	12	0,7	8	CW	D	35	594721	595733				
TS8E4	22	12	0,7	8	CW	G	54	594721	595733				
TS8E5	22	12	0,7	8	CW	D	35	594721	595733				
TS8E6	22	12	0,85	9	CW	D	37	594721	594726				
TS8E6(B)	22	12	0,85	9	CW	D	37	594721	594287				
TS10E1	22	12	1	8	CW	G	80	594721	594734				
TS10E3	22	12	0,85	8	CW	D	50	594721	594436				
TS10E4	22	12	0,85	8	CW	D	50	594721	594436				
TS10E5	22	12	0,85	8	CW	D	50	594721	594436				
TS10E5(B)	22	12	0,85	8	CW	D	50	594721	594436				
TS10E11	22	12	1	8	CW	G	80	594721	594734				
TS12-77	22	12	1,2	9	CW	G	35	594650	594644			595660	
TS12E9/B	22	12	1,4	10	CW			594650	595656			595721	
TS12E30	22	12	1,2	9	CCW	D	40	594650	594685			595594	
TS12E36	22	12	1,2	9	CW	D	58	595711	595712			595580	
TS12E200	22	12	1,2	9	CW	G	80	594650	595764			595660	
TS12E901	22	12	1,2	11	CW	D	50	594650	595575			595660	
TS12E902	22	12	1,2	9	CW	D	50	594650	594644			595660	
TS12ER15	23	12	1,2	9	CW	D	166	595610	594716			595720	
TS12ER15M	23	12	1,2	9	CW	D	166	595610	594716			595720	
TS12ER19	23	12	1,2	9	CW	G	4	594650	594716			594719	
TS12ER20	23	12	1,1	10	CCW	D	54	595610	594666			594672	
TS12ER22	23	12	1,1	11	CCW	D	54	595610	595695			594672	
TS12ER22M	23	12	1,1	11	CCW	D	54	595610	595695			594672	
TS12ER25	23	12	1,1	10	CCW	G	74	595610	594666			594672	
TS14E6	22	12	1,4	10	CW	D	23	595642	595698			595648	
TS14E7	22	12	1,4	10	CW	G	25	595642	595698			595648	
TS14E16	22	12	1,4	10	CW	G	20	595642	595698			595648	
TS14E17	22	12	1,4	10	CW	D	25	595642	595698			595648	
TS14E42	22	12	1,4	10	CW	G	19	595642	595643			595648	
TS14E110	22	12	1,4	11	CW	G	38	594650	595575			595580	
TS18E1(b)	22	12	2	11	CCW	G	42	594683	595639				
TS18E7	22	12	1,5	10	CW	G	45	594621	594465				
TS18E13	22	12	1,5	11	CW	G	37	594781	595597			595601	
TS18E33	22	12	1,8	10	CW	D	75	594781					
TS18E3(b)	22	12	2	11	CCW	G	42	594683	595641				
TS18E331	22	12	1,8	10	CW	D	75	594781	595679			595655	
TS18ER20(b)	23	12	2	12	CCW	D	54	595621	595634				
TS18ER21	23	12	2	12	CCW	G	42	595621	595622				
TS18ER22	23	12	2	12	CCW	D	53	595621	595634				
TS18ER23	23	12	2	12	CCW	G	41	595621	595634				
TS18ER121(b)	23	12	2	12	CCW	G	42	595621	595622				
TS18ER123	23	12	2	12	CCW	G	42						
TS18ER123(b)	23	12	2	12	CCW	G	42	595621	595634				
TS22-31	22	12	2,2	10	CW	G	37	594683	594747			595655	
TS22-32	22	12	2,2	10	CW	G	37	594786	594747			595655	
TS22-33	22	12	2,2	10	CW	G	37	594786	594747			595655	
TS22E5	22	12	2,2	10	CW	G	36	594683	594747				
TS22E5(D)	22	12	2,2	10	CW			594683	594747			595655	
TS22E8(A)	22	12	2,2	10	CW	G	102	594683	594747			595655	
TS22E8(B)	22	12	2,2	10	CW	G	102	594683	594747			595655	
TS22E8(C)	22	12	2,2	10	CW	G	102	594683	594747			595655	
TS22E9(b)	22	12	2,2	10	CW			594683	594747			595655	
TS22E20	22	12	2,2	9	CW	G	62	594683	595724			595655	
TS22E26	22	12	2,2	11	CW	D	55	594683	595597			595601	
TS22E45	22	12	2,2	10	CW	G	18	594683	595604			595608	
TS22ER12	23	12	2,2	12	CW	D	7	594683	595683			595684	
TS22ER13	23	12	2,2	12	CW	D	7	594683	595683			595684	
TS24E2(A)	22	12	2,4	10	CW			594683	594747			595655	
TS24E3	22	12	2	8	CW	G	65	595631	594790				
TS24E6	22	12	2,2	10	CW	G	71	594683	594747			595655	
TS24E7	22	12	2,2	10	CW	G	45	594683	594747			595655	
TS24E13	22	12	2,4	11	CW	D	73	594683	595597				
TS24E30	22	12	2	8	CW	G	65	595631	594790			595732	









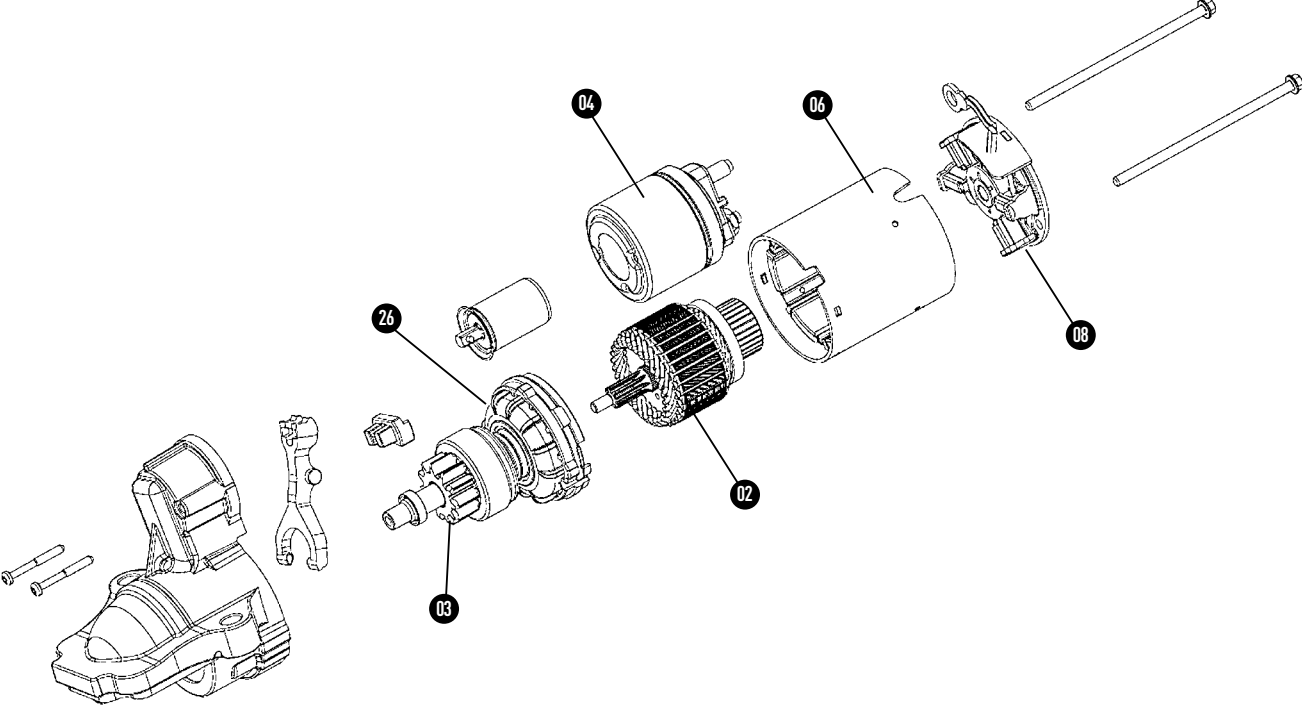

TC							
TS8E2	594348	594522	594290	594456	594289		594507
TS8E3	594452	594522	594290	594456	594289		594697
TS8E4	594452	594522	594290	594456	594289		
TS8E5	594481	594522	594290	594456	594289		
TS8E6		594522	594290	594456	594289		594506
TS8E6(B)		594522			594417		
TS10E1	594735	594478	594479	594457	594289		594736
TS10E3	594653	594477	594351	594457	594289		594510
TS10E4	594438	594477	594351	594457	594289		594510
TS10E5	594355	594477	594351	594457	594289		594510
TS10E5(B)	594355	594477		594457	594289		
TS10E11	595765	595767			594417		
TS12-77	595731	594648	595659		595734		
TS12E9/B	595657		595659	595661	595734		
TS12E30	595591	594687	595592	595595	594645		595593
TS12E36	595713	595714		595715	595662		
TS12E200	595765	595766			595662		
TS12E901	595739		595659	595661			
TS12E902	595739		595659	595661			
TS12ER15	595718			595613	595719		
TS12ER15M	595718	594718			595719		
TS12ER19	595611			595613	594667		
TS12ER20	595611		594674	595613	594667		595615
TS12ER22	595726			595613	594667		
TS12ER22M	595726		594674		594667		
TS12ER25	595611		595592	595613	594667		595612
TS14E6	595702	595700			595662	595737	
TS14E7	595701	595700			595662	595736	
TS14E16	595699	595700			595662	595736	
TS14E17	595699	595700			595662	595738	
TS14E42	595644				595649	595646	595647
TS14E110	595576	595577			594645	595578	595579
TS18E1(b)	595617	595623			595628		595640
TS18E7	594454	594469		594752	594616		595590
TS18E13	595731	595680		594752			
TS18E33		594782	594780	594752			
TS18E3(b)	595617	595623			595628		594676
TS18E331			594780				
TS18ER20(b)	595617	595623			595628		
TS18ER21	595735	595623			595628		
TS18ER22	595617	595623			595628		
TS18ER23	595735	595623			595628		
TS18ER121(b)	595617	595623			595628		595625
TS18ER123	594617						
TS18ER123(b)	595617	595623			595628		595635
TS22-31	595654	594750		594752	595620		
TS22-32	594658	594750		594752			
TS22-33	595760	594750		594752			
TS22E5	595673	594750		594752	594748		594751
TS22E5(D)	595673	594750		594752			
TS22E8(A)	594658	594750		594752			
TS22E8(B)	594658	594750		594752			
TS22E8(C)	594658	594750		594752			
TS22E9(b)	595654	594750		594752	595620		
TS22E20	595723	595725		594752	595620		
TS22E26	595731	595681		594752	594778		
TS22E45	595605	595606		594752	595602		595607
TS22ER12	595598	595632			595633		
TS22ER13	595598	595632			595633		
TS24E2(A)	594658			594752			
TS24E3	594784	594788			594785		
TS24E6	595653	595665	595619		595620		
TS24E7	595618	595665	595619		595620		
TS24E13	595598	595599		594752	595602		595600
TS24E30	594784	595665		594752	594785		







---

**NOTES NOTES NOTAS NOTAS NOTE NOTITIES NOTIZEN NOTATAKI NOT ПРИМЕЧАНИЯ POZNAMKY**

---



										
FS10B3	24	12	1,2	8					<b>501640</b>	
FS10E3(b)	24	12							<b>595581</b>	
FS10E10	24	12	1,4	9	CW	D	60		<b>595581</b>	
FS10E10(b)	24	12	1,4	9	CW	D	60		<b>595581</b>	

TC	 03	 26	 04	 06	 08	 10	 11
FS10B3		501490	501790	501760	501401		
FS10E3(b)					595585	595587	595586
FS10E10	595582		595583		595585	595587	595586
FS10E10(b)	595582		595583		595585	595587	595586

---

**NOTES NOTES NOTAS NOTAS NOTE NOTITIES NOTIZEN NOTATAKI NOT ПРИМЕЧАНИЯ POZNAMKY**

---









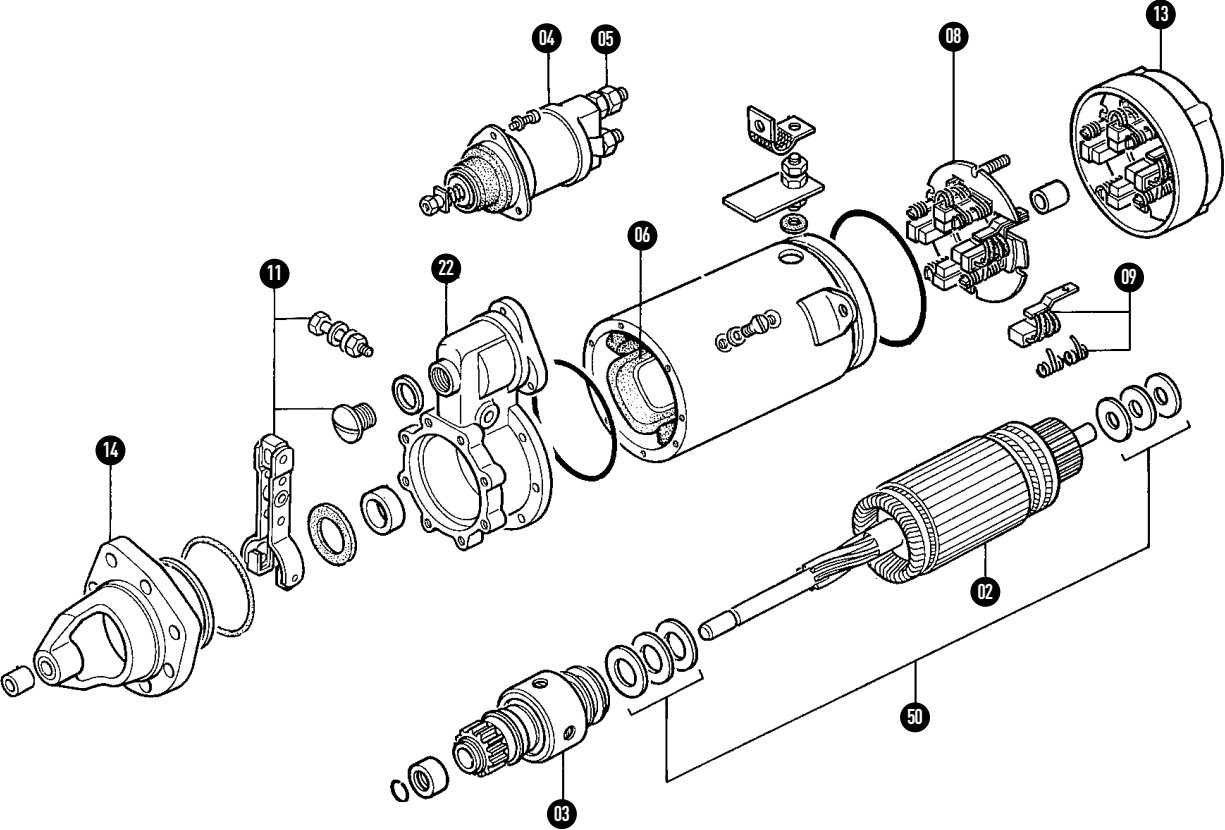

# D13HP

# 2.7

## 25 D13HP



TC							02	03	04	05	
	25	24	7,2	11	CW	D					70
D13HP601	25	24	7,2	11	CW	D	70		594295	594296	594297
D13HP605	25	24	6,6	12	CW	GD	45	594219	253066	594220	
D13HP607	25	24	6,6	12	CW	D	60	594219	253066	594220	
D13HP608	25	24	7,2	12	CW	D	55	594219	253066	594220	594292
D13HP609	25	24	7,2	12	CW	D	28	594219	253066	594193	594328
D13HP613	25	24	7,2	11	CW	D	55	594219	594291	181142	
D13HP701	25	24	7,7	12	CW	D	140		253066	594193	
D13HP702	25	24	7,7	12	CW	D	60	594192	253066	594075	
D13HP703	25	24	7,7	12	CW	GD	45	594192	253066	181142	
D13HP704	25	24	7,7	12	CW	D	146	594192	253066	594193	
D13HP705	25	24	7,7	12	CW			594192	253066	594075	
D13HP709	25	24	8	11	CW			594192	594291	594075	594292

TC	 06	 08	 09	 11	 13	 14	 22	 50
D13HP601	594221	594301	594286			594299	594201	
D13HP605	594221	594222	594286	182036	594223	594204	594201	
D13HP607	594221	594222	594286	182036	594223	594218	594201	
D13HP608	594221	594222	594286	594293	594223	594205	594201	
D13HP609	594221	594329	594286	594293	594223	594226	594201	594202
D13HP613	594221	594301	594286	594293		594205	594201	
D13HP701	594195	594076	182037	182036	594198		594201	594202
D13HP702	594195	594076	182037	182036	594198	594218	594201	
D13HP703	594195	184630	182037	182036		594204	594201	
D13HP704	594195	594076	182037		594198	594226	594201	594202
D13HP705	594195	594076	182037	182036	594198			
D13HP709	594195	594076	182037	594293	594198	594205	594201	



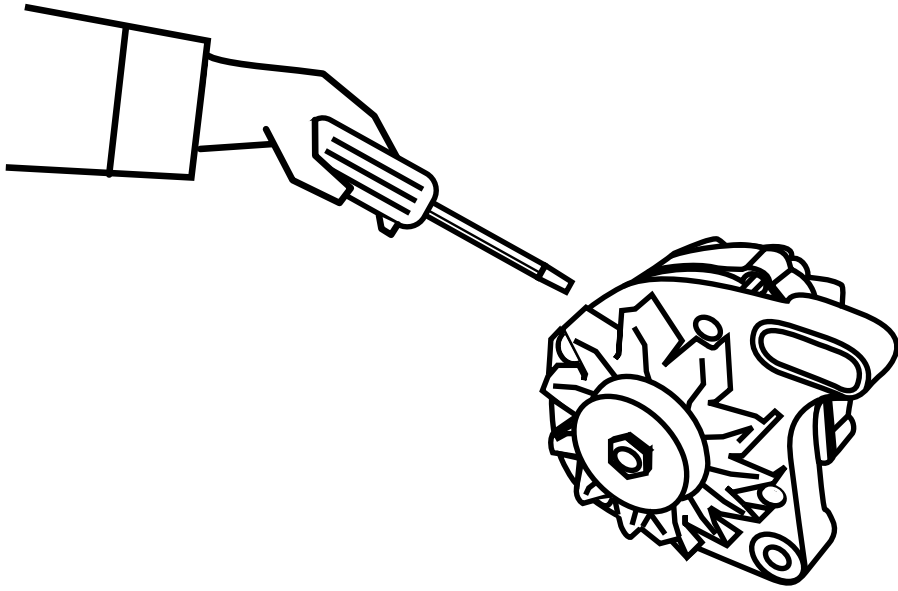

YH - YL > YV - YM

**YV - YM 16**

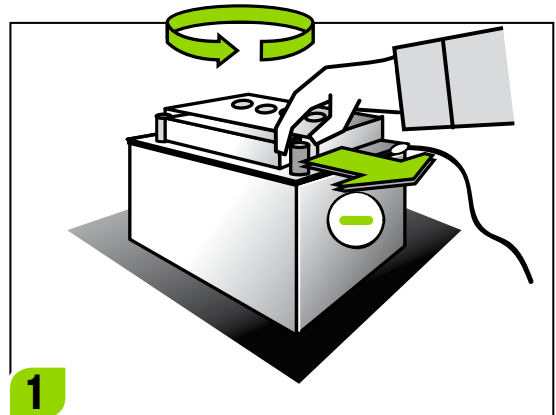
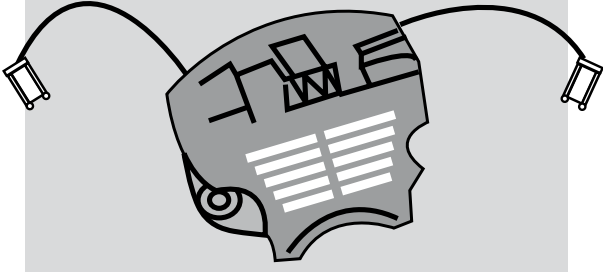

**1**

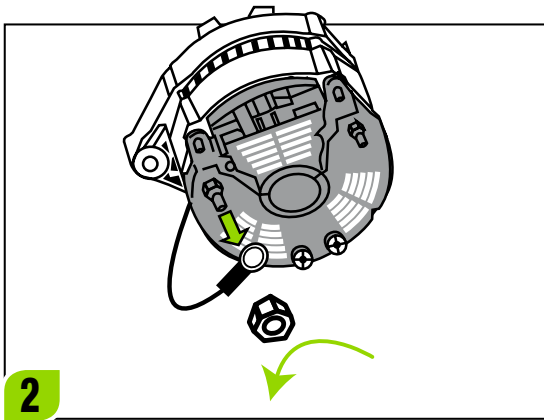

**2**

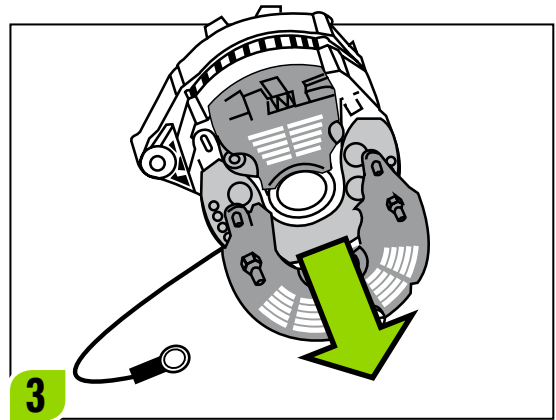

**3**

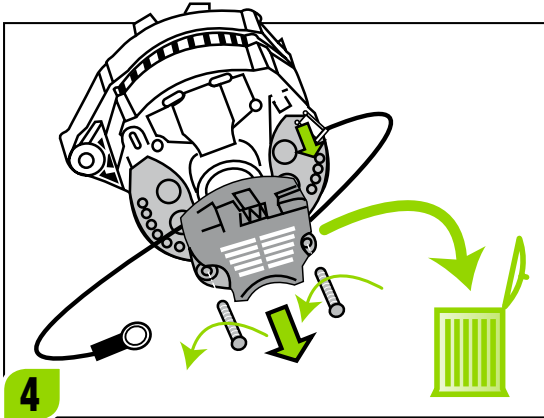

**4**

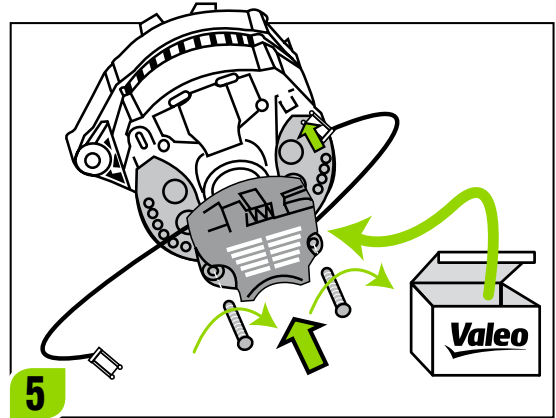

**5**

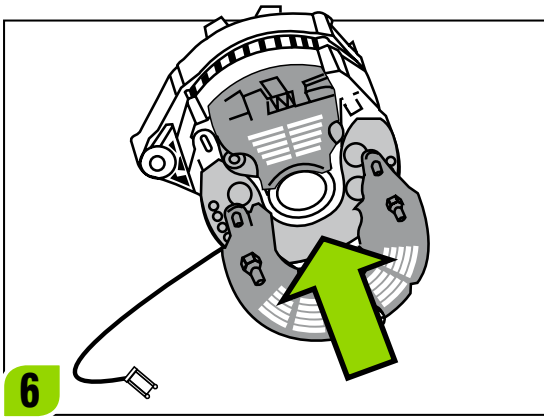

**6**

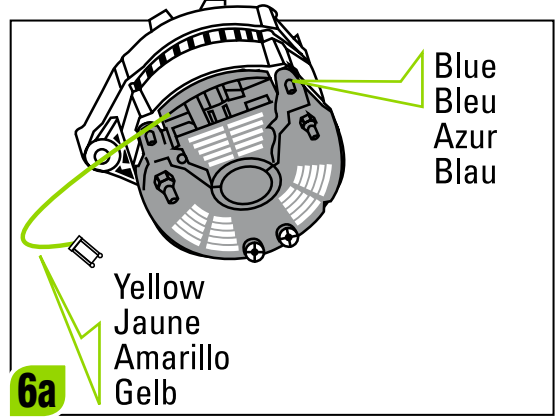

**6a**

**PARIS-RHÔNE**  
YL 122

**MARCHAL**  
72590602

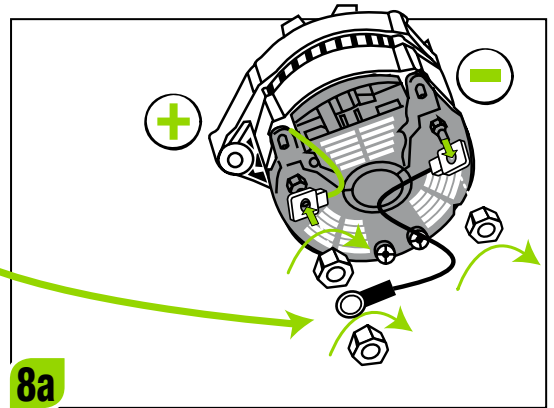
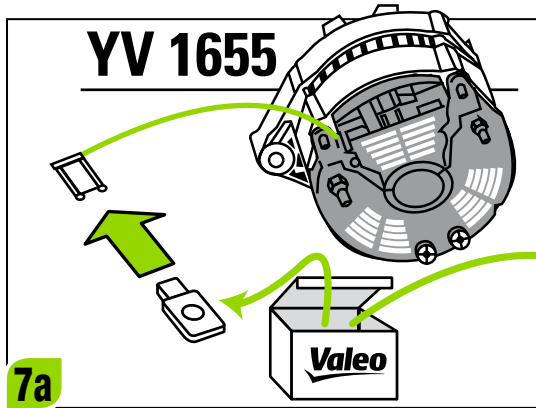

**PARIS-RHÔNE**  
YL 129  
YL 149  
YL 155  
YH 1649  
YH 1655

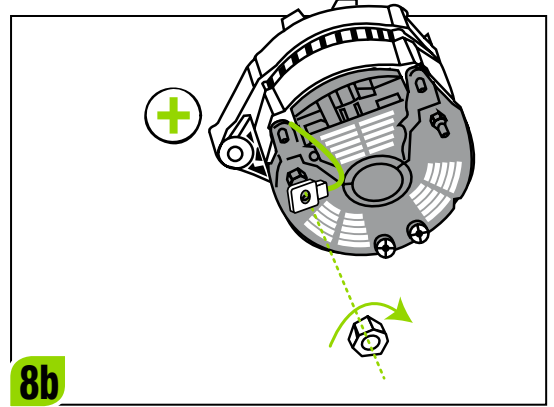
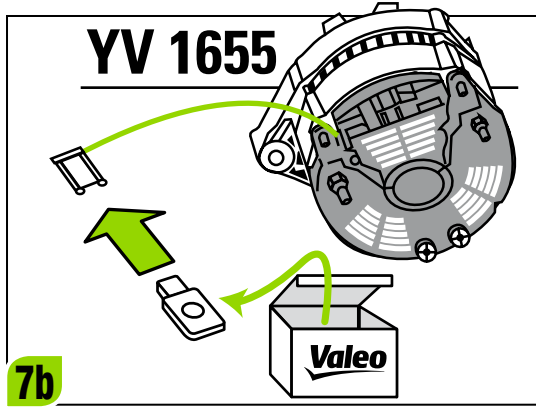

**PARIS-RHÔNE**  
YL 126 - YL 138  
YL 152 - YH 154  
YH 1652 - YH 1654  
YH 139 - YH 1639  
YV 1653

**MARCHAL**  
72590702

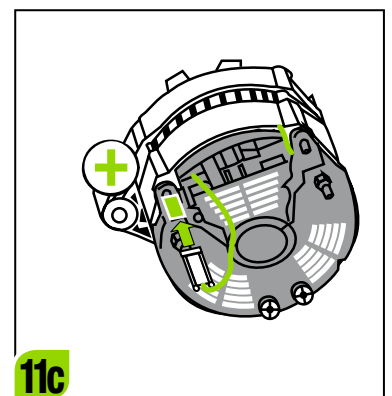
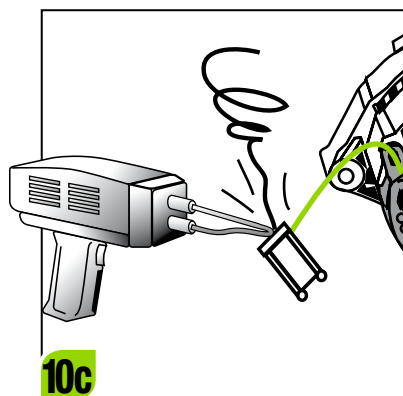
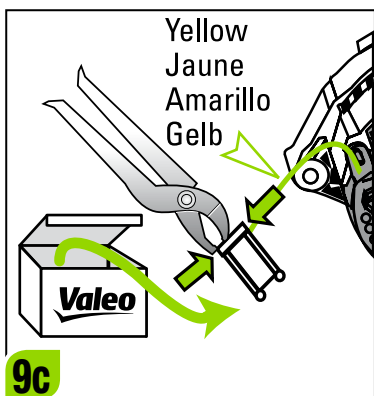
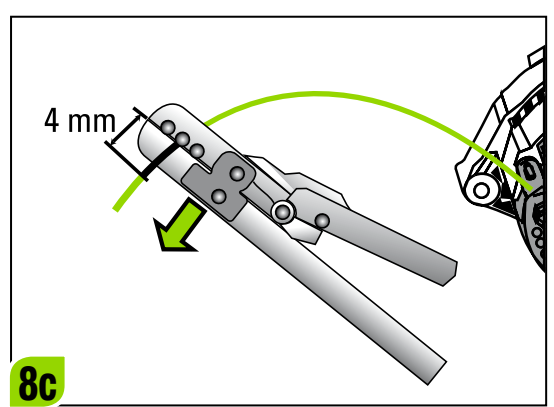
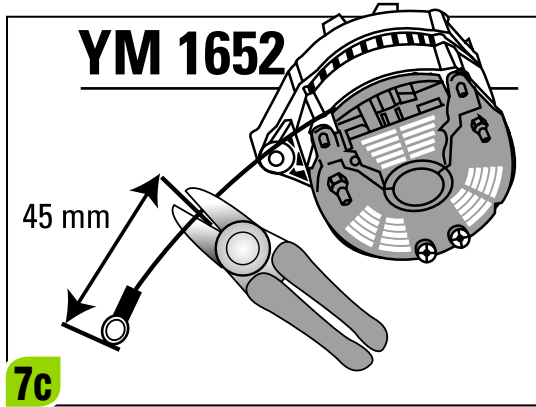

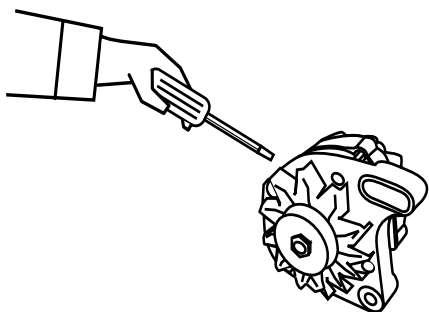

**Valeo**



Regulator • Régulateur  
 Regulador • Regulador  
 Regolatore • Regelaar  
 Regler • Regulatora  
 Конжектор • Контакт

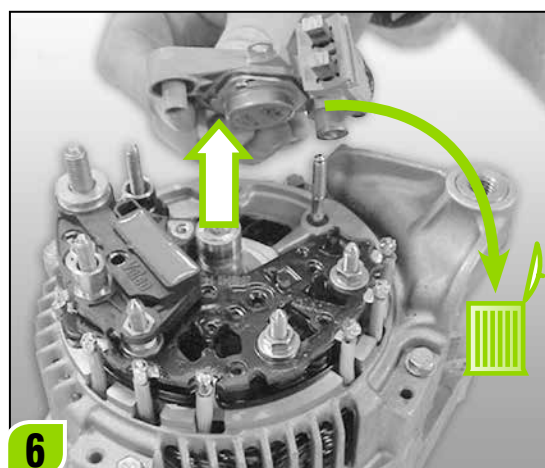
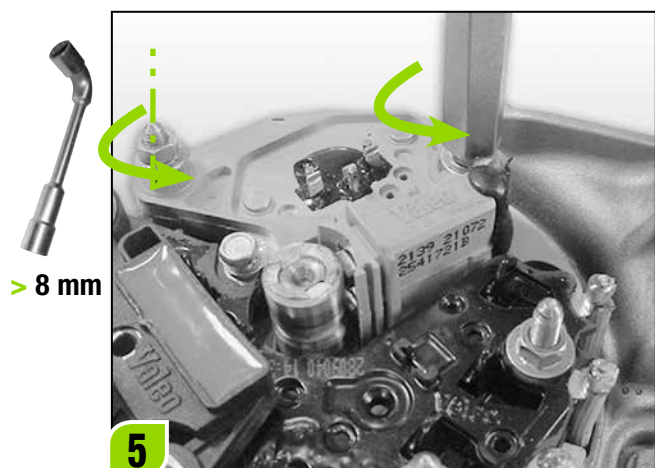
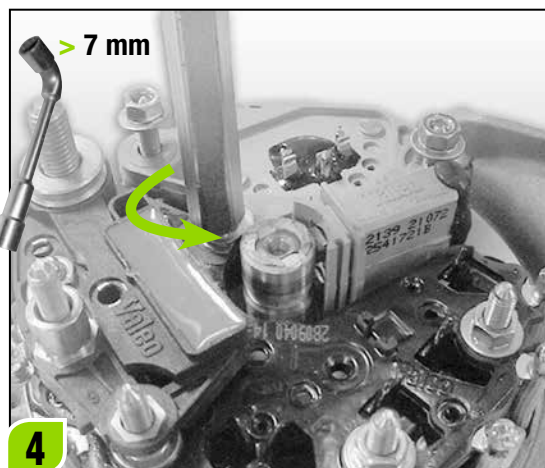
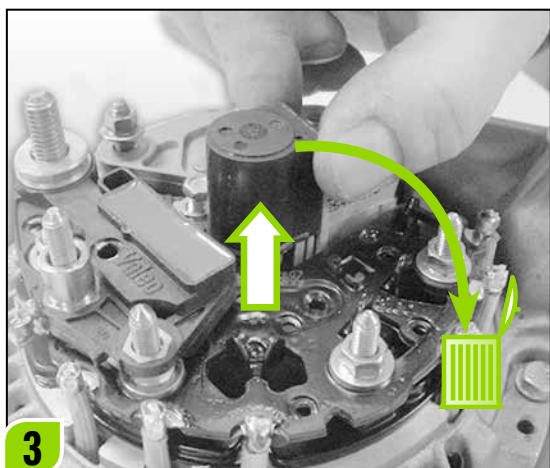
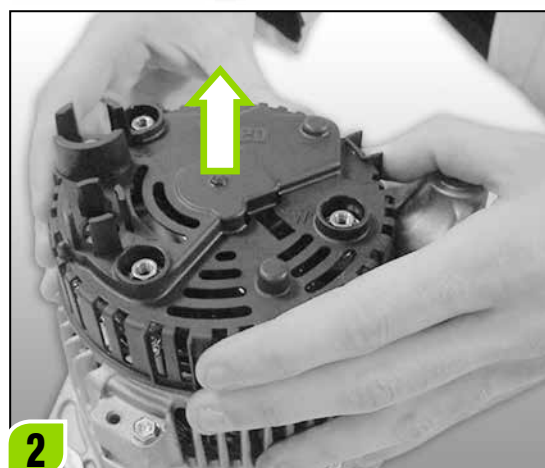
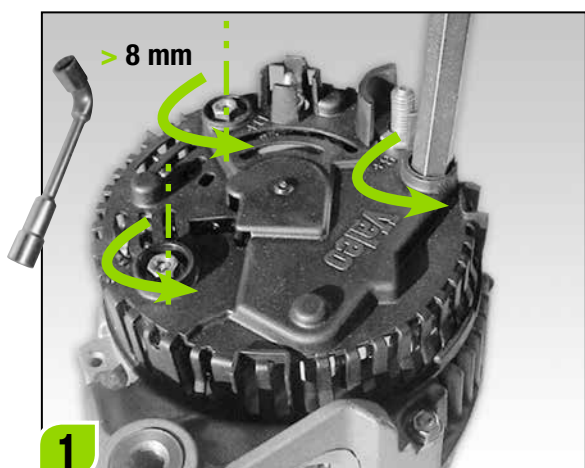



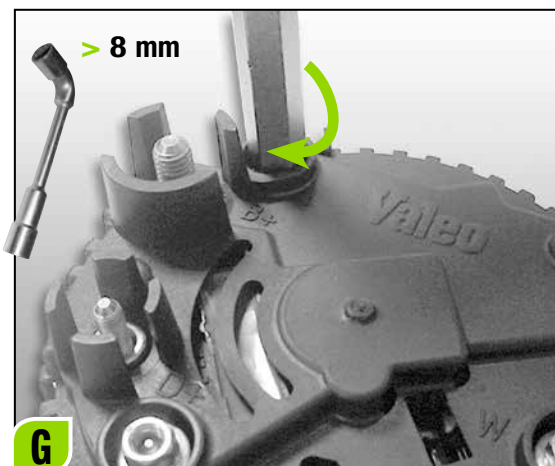
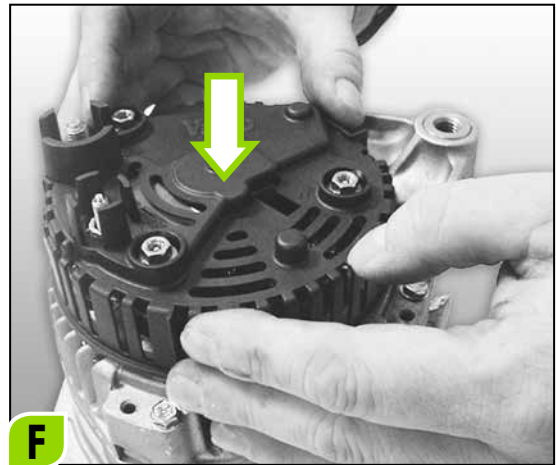
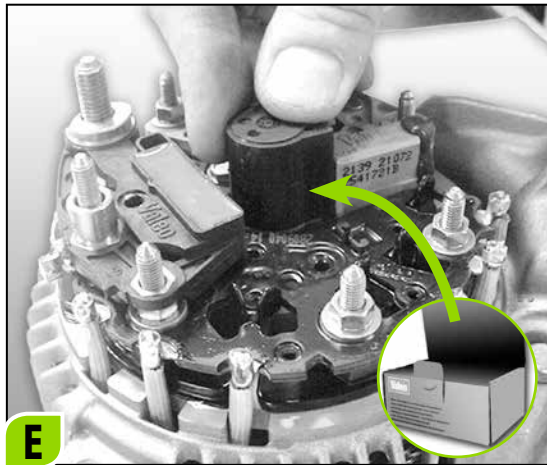
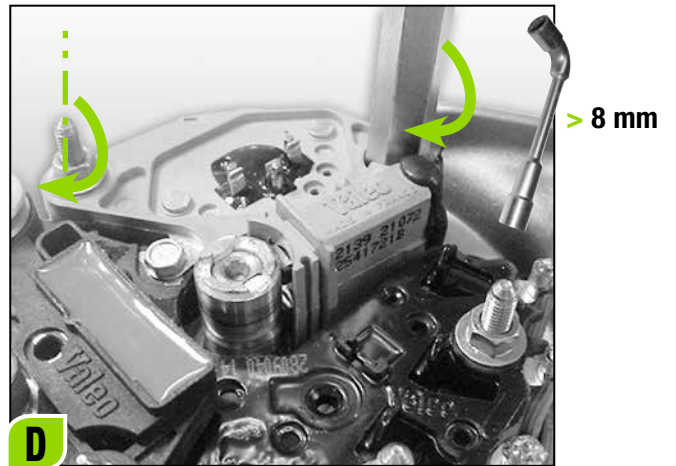
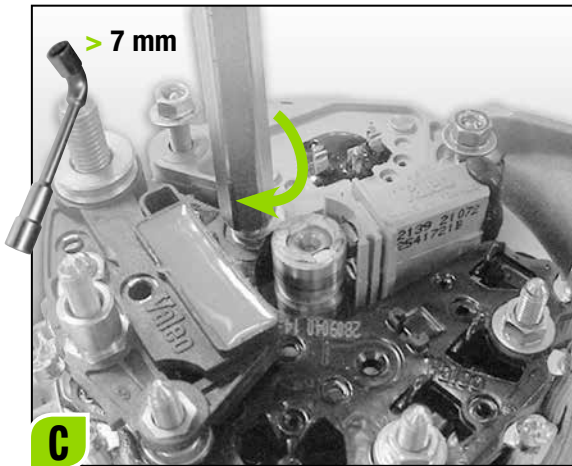
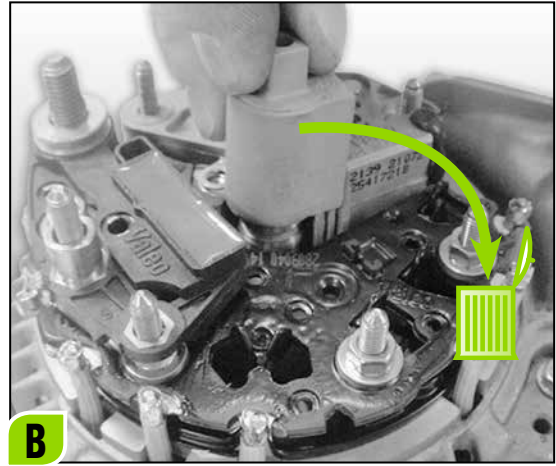
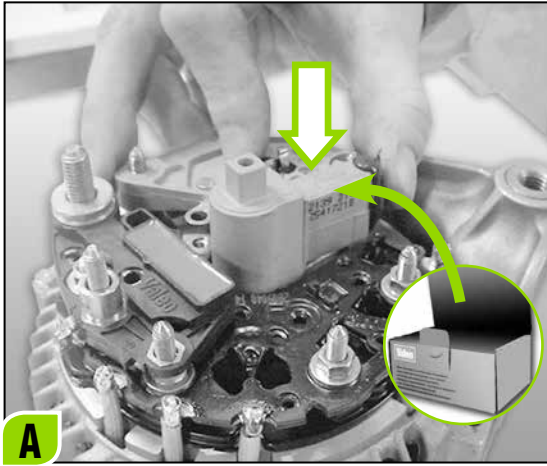

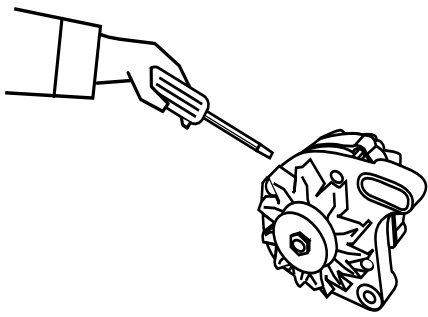

- Rectifier • Pont de diodes
- Placa de diodos • Placa de diodos
- Ponte diodi • Diodebrug
- Diodenbrücke • Mostek diodowy
- Diod körpüsü • Выпрямитель/Диод

1 ▶ 6

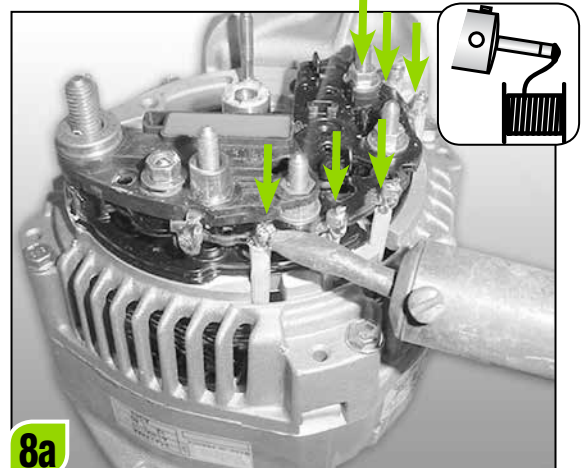
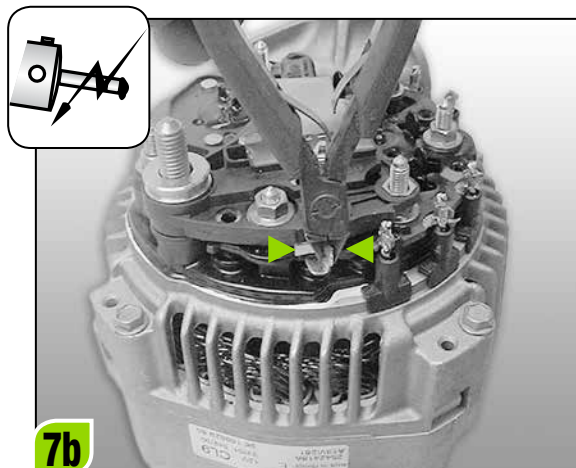
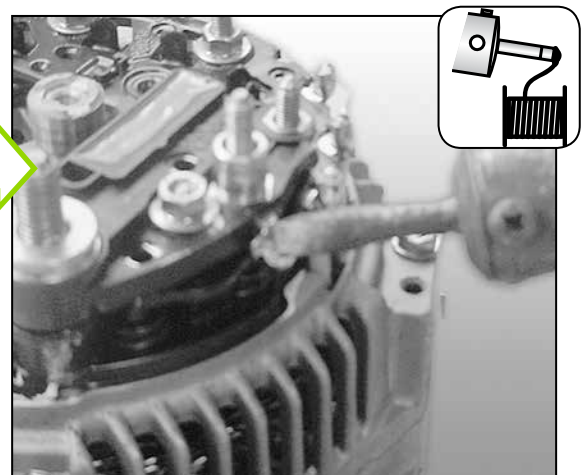
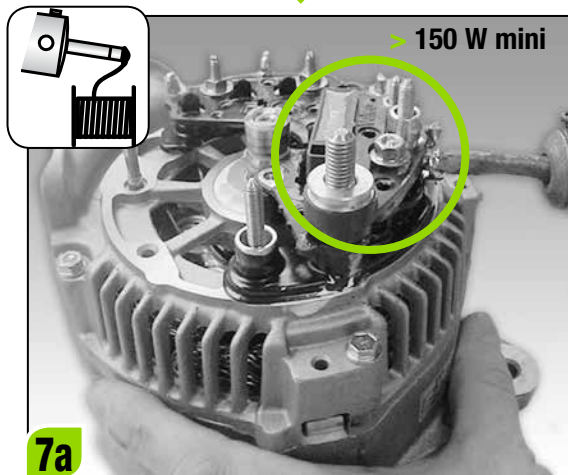

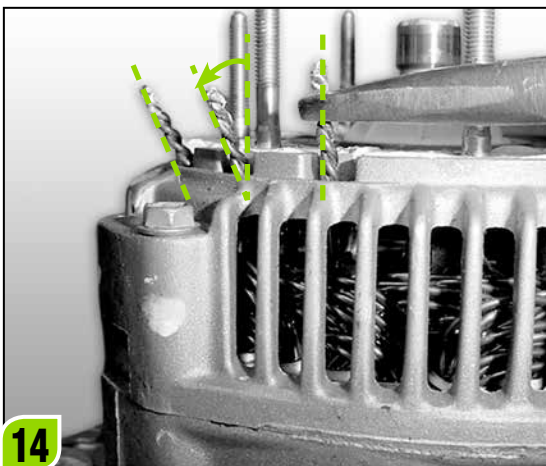
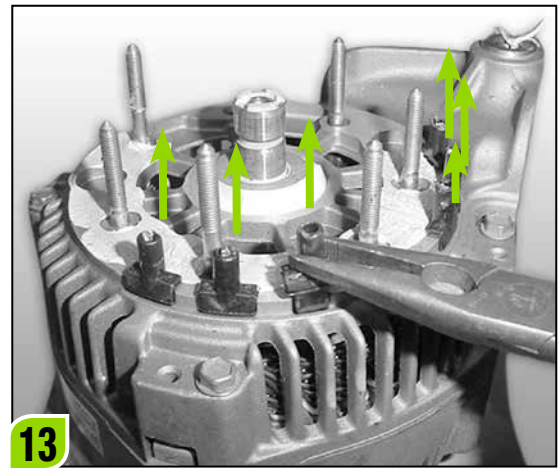
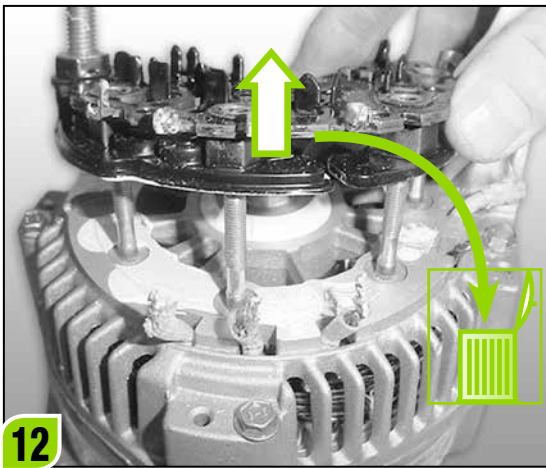
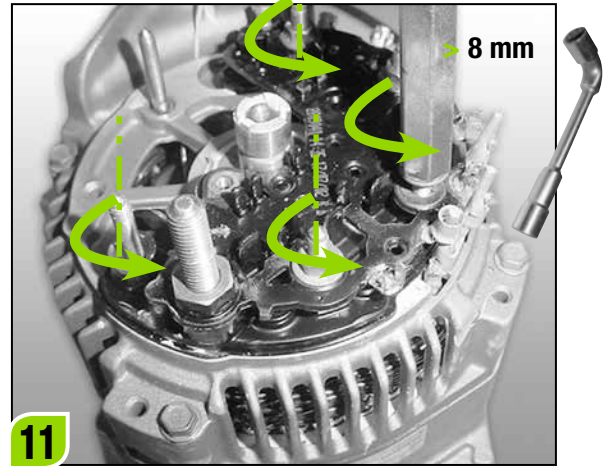
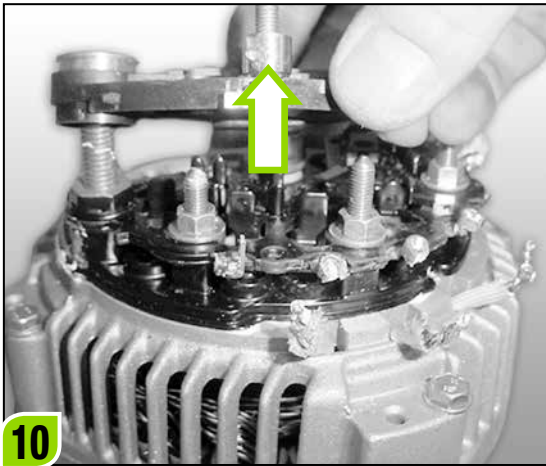
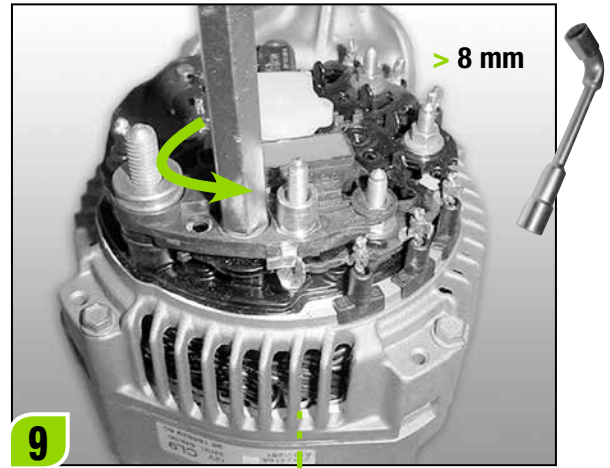
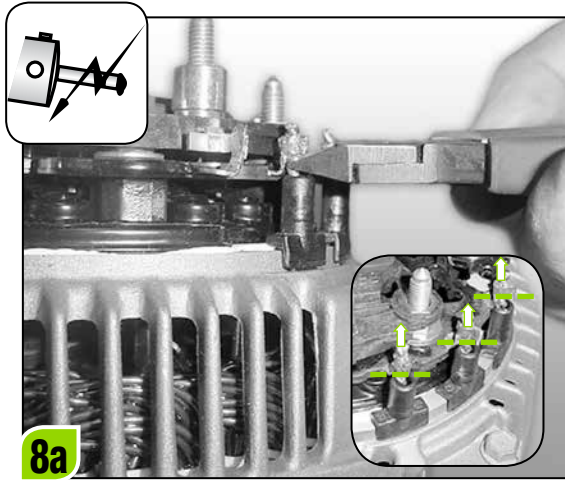

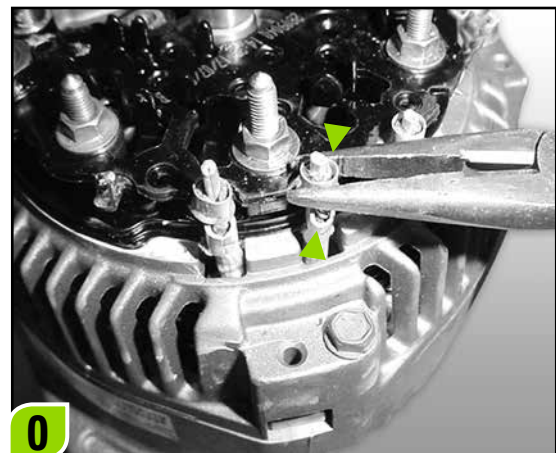
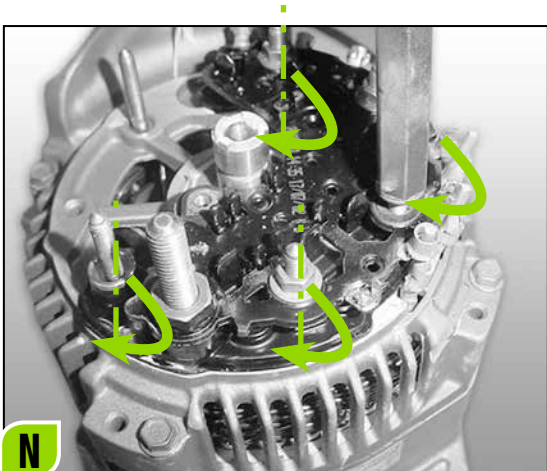
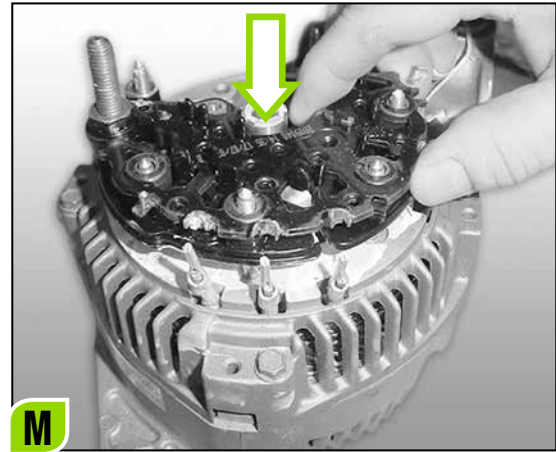
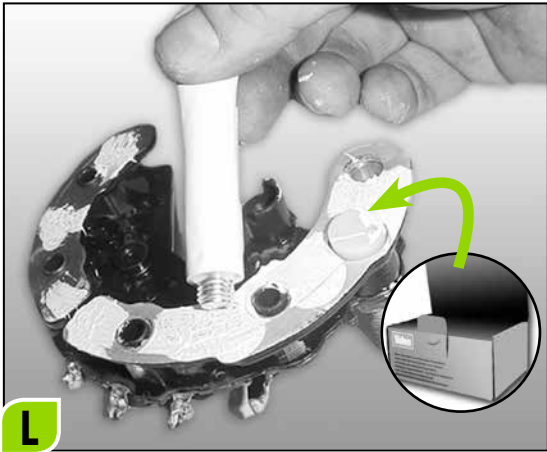
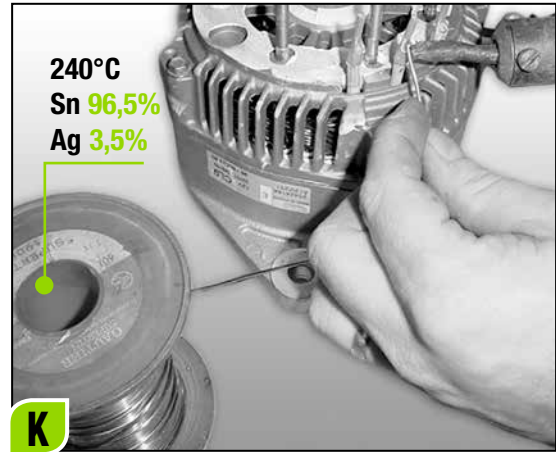
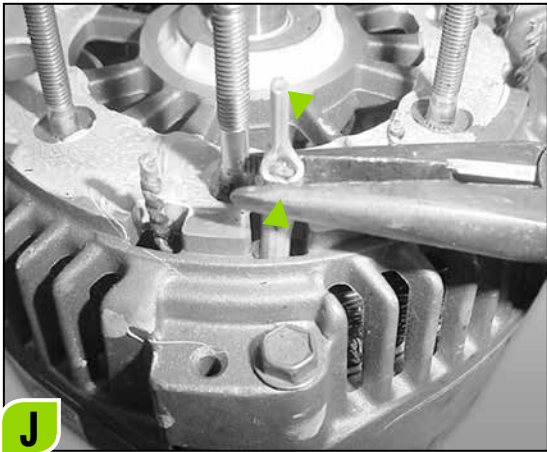
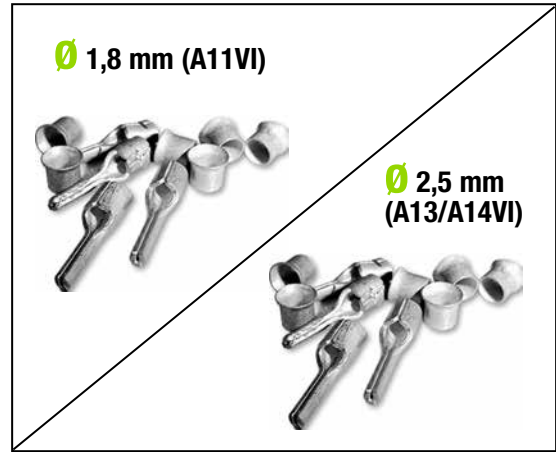
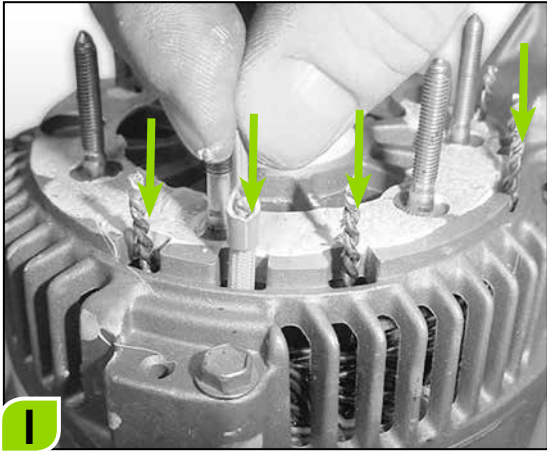

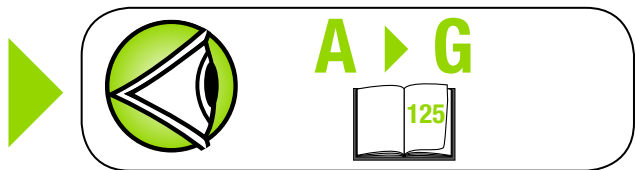
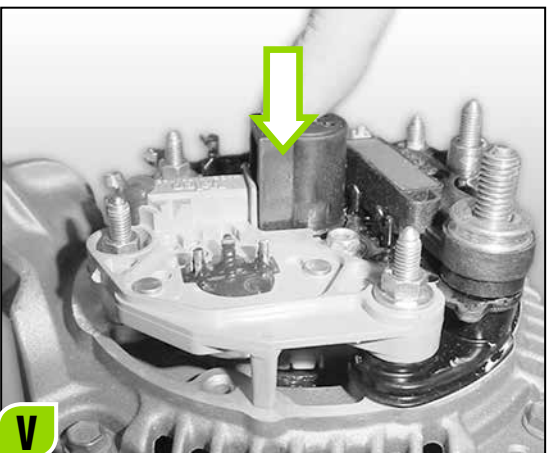
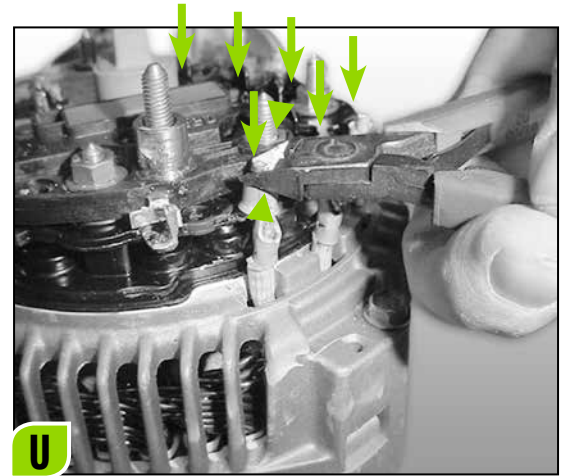
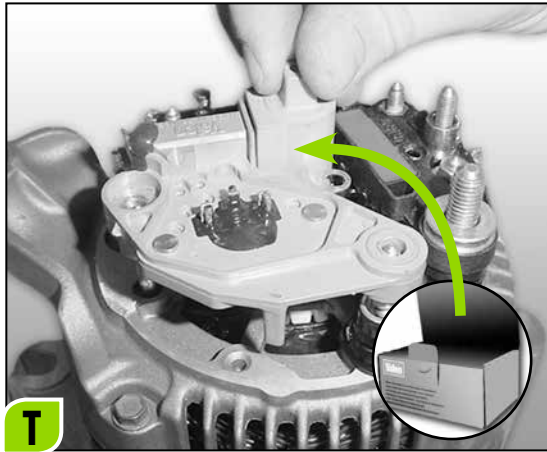
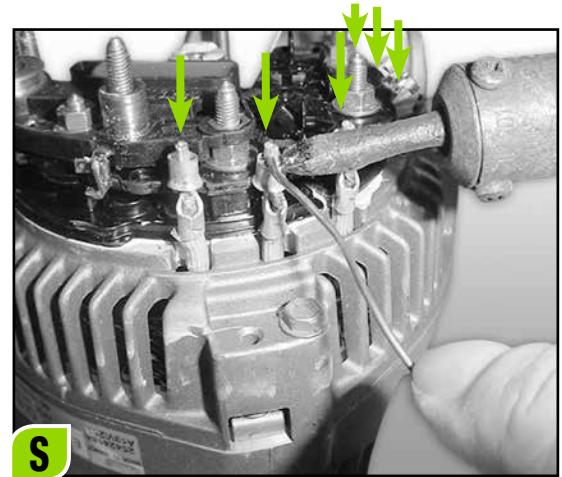
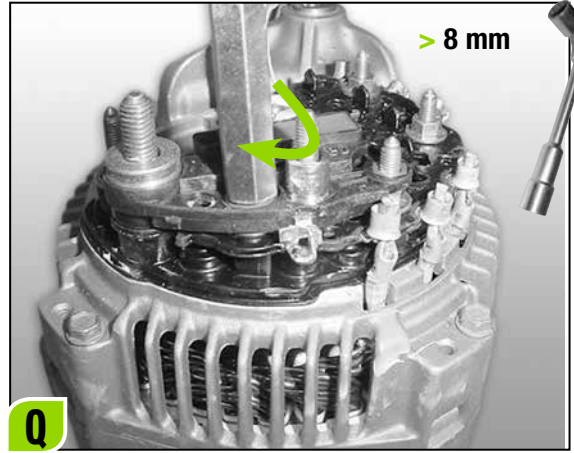
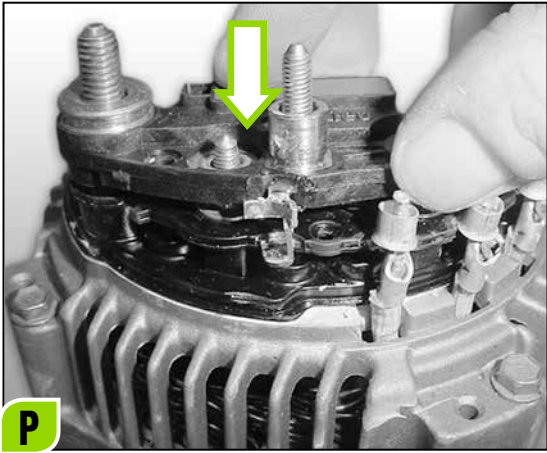



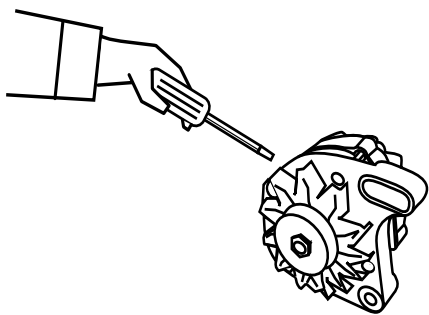





- Rotor • Rotor
- Rotor • Rotor
- Rotore • Rotor
- Rotor • Wirnik
- Rotor • Якорь





**1** ▶ **6 + 7** ▶ **14**

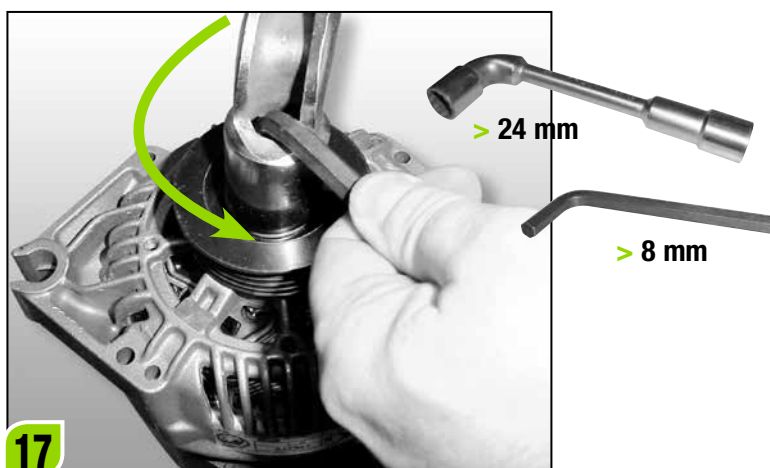
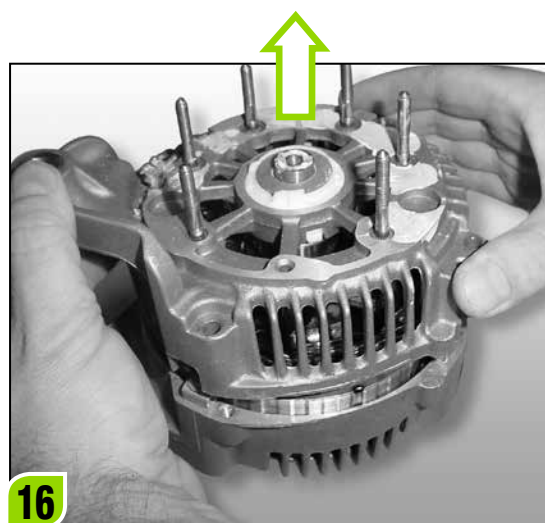
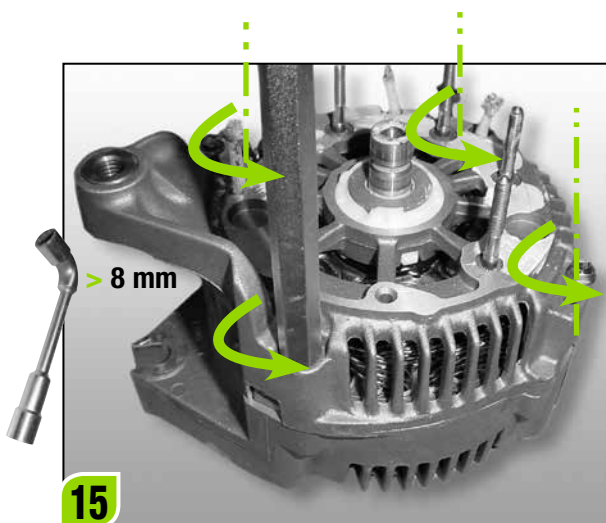

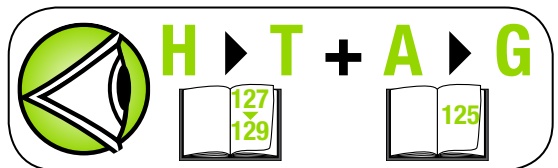
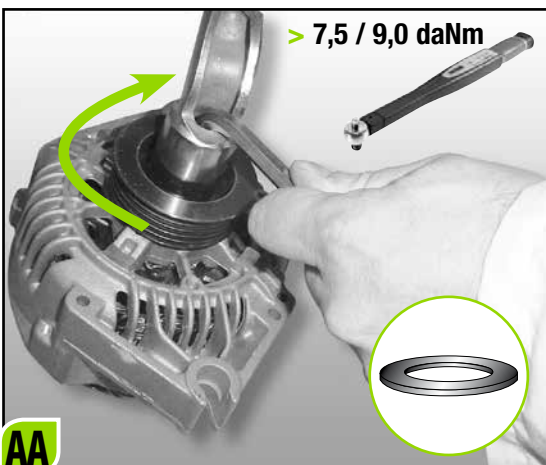
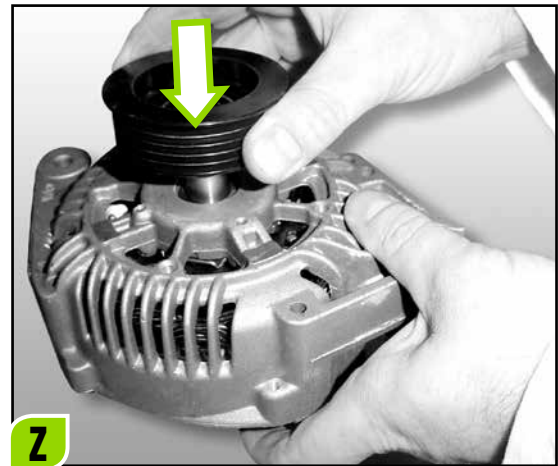
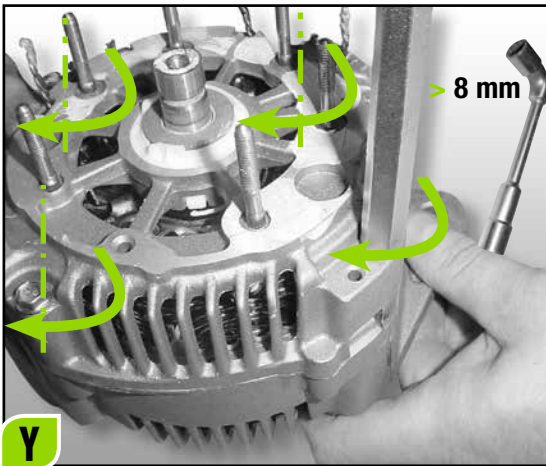
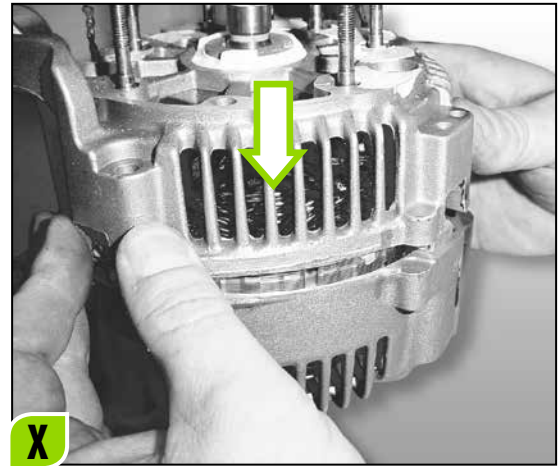
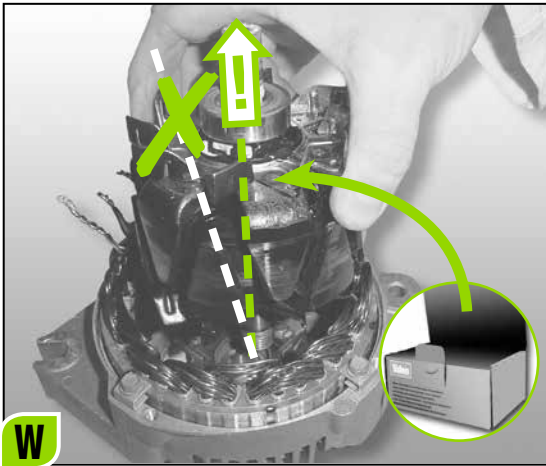
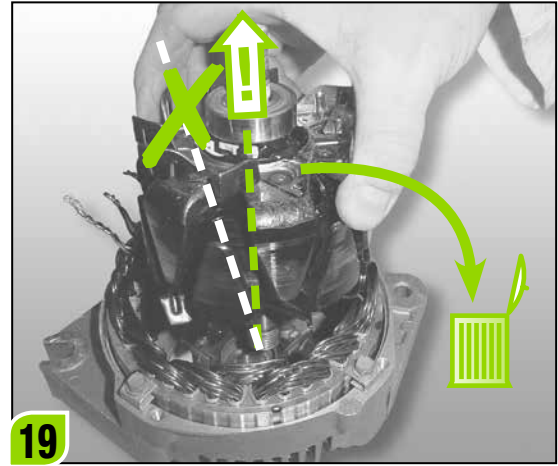
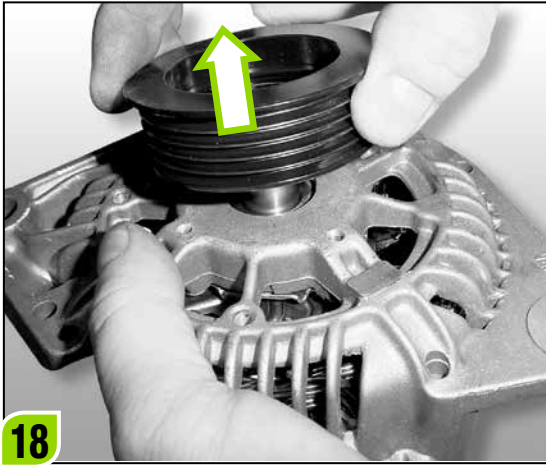



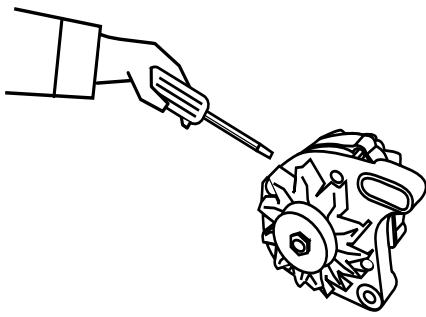

- Stator • Stator
- Estator • Estator
- Statore • Stator
- Stator • Stojan
- Stator • Статор

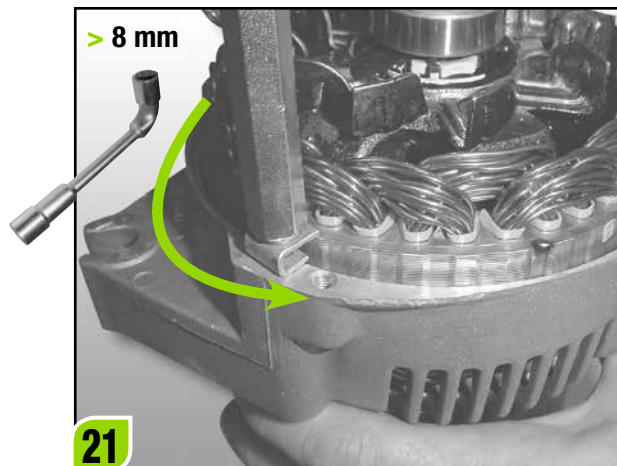
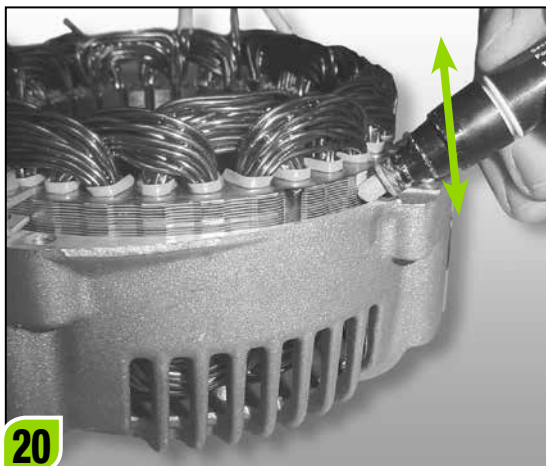
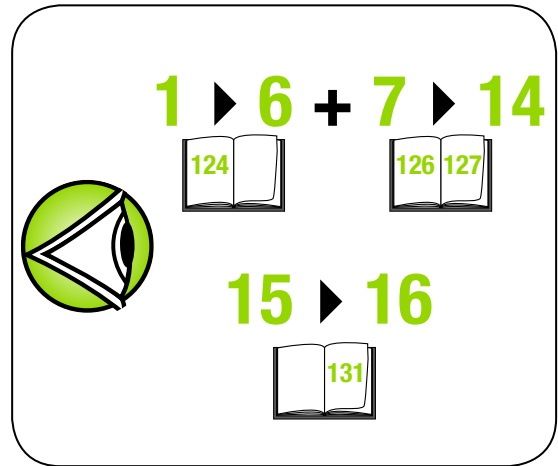
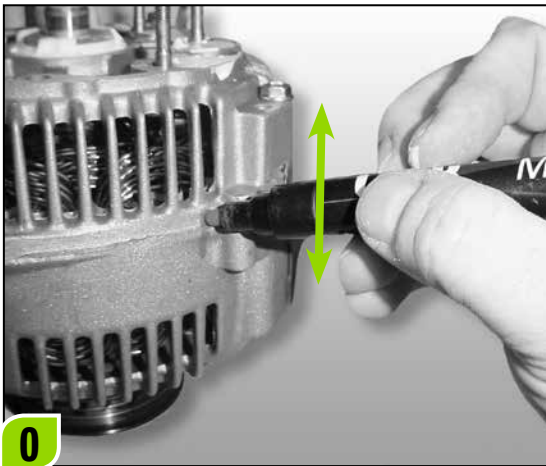

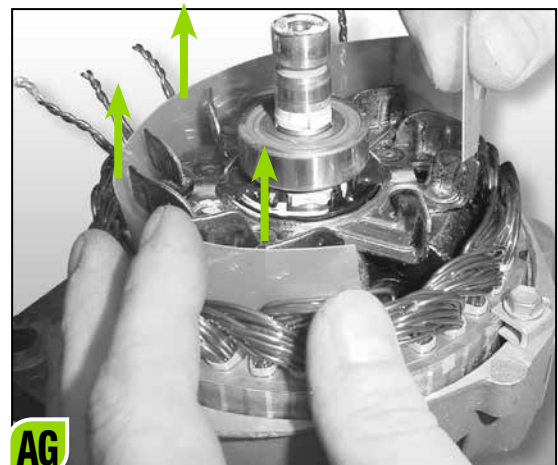
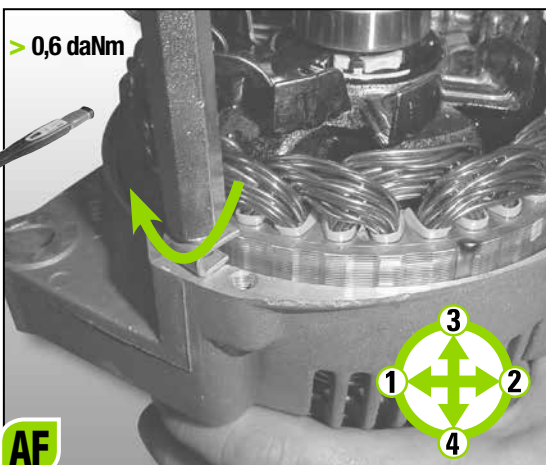
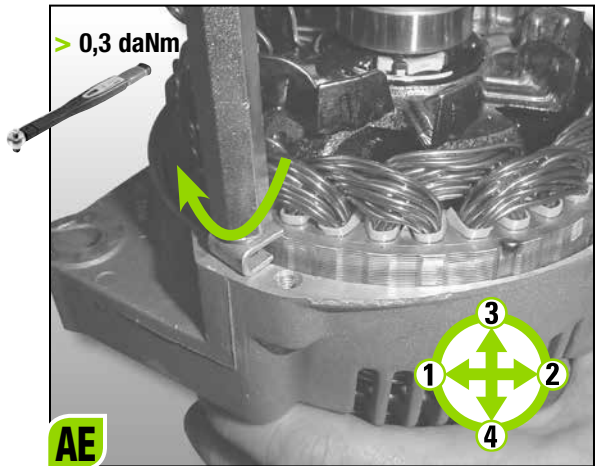
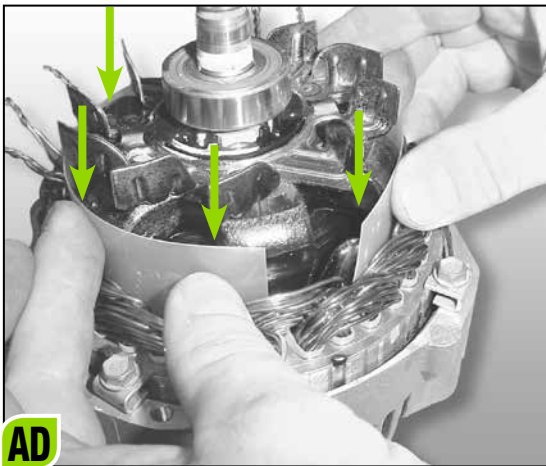
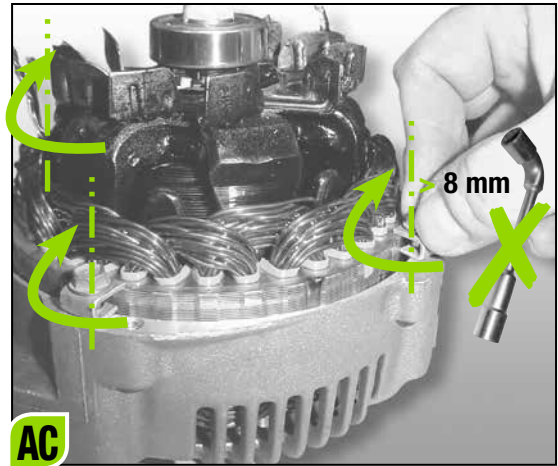
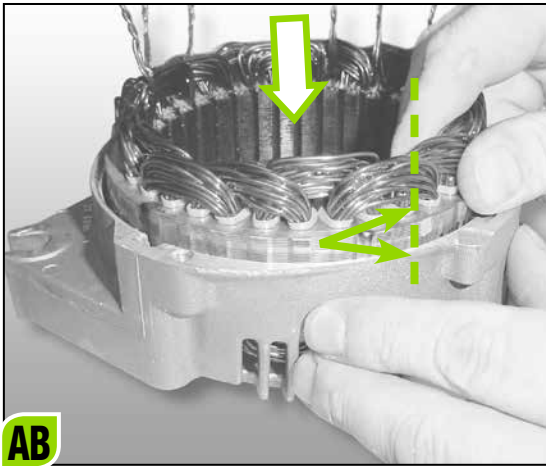
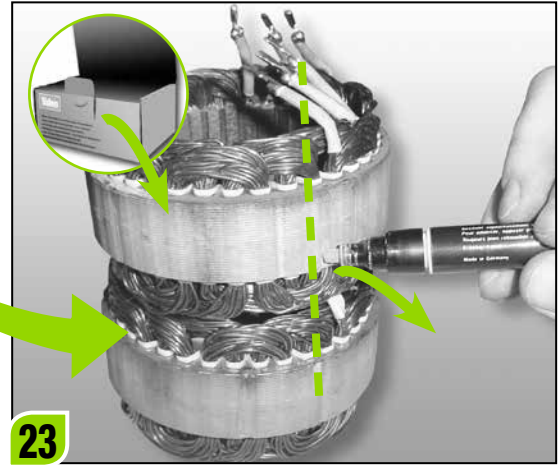
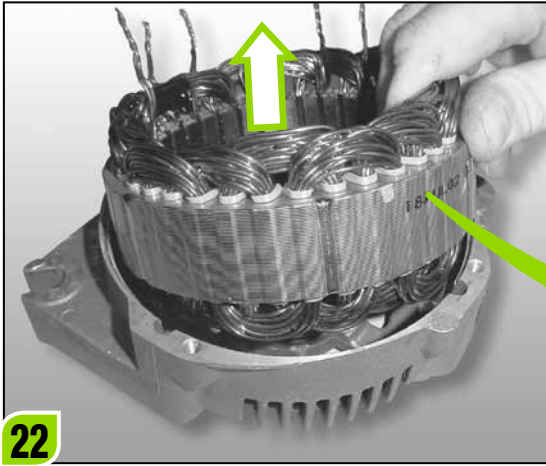

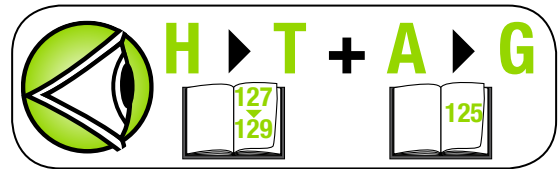
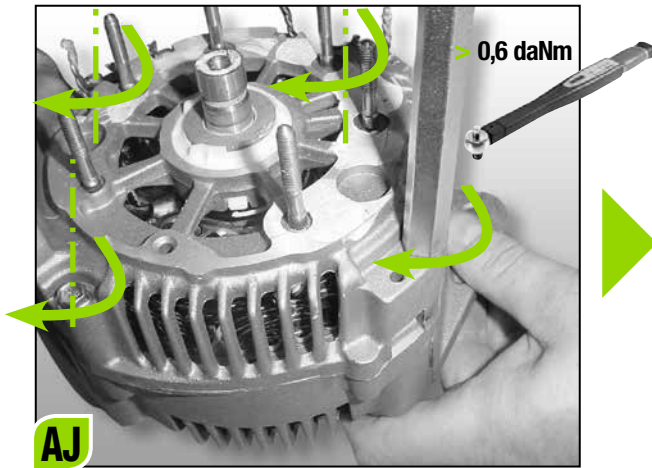
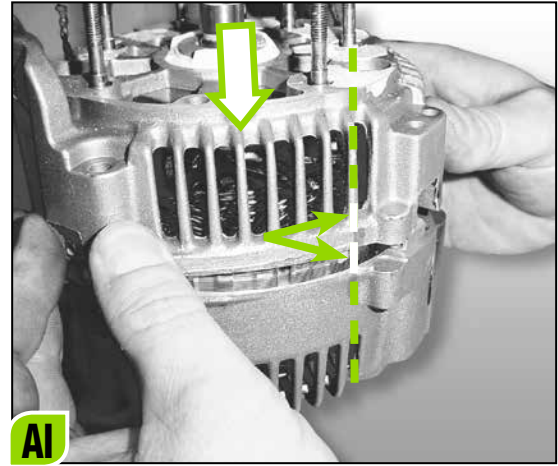

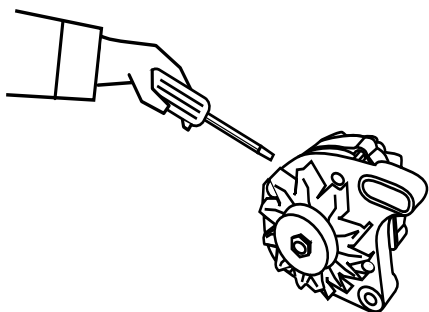

- Front Bracket • Palier avant
- Tapá delantera • Tampa Dianteira
- Supporto anteriore • Voorste behuizing
- Vorderes Lagerschild • Przednia obudowa
- Ön karak • Передняя/кронштейн

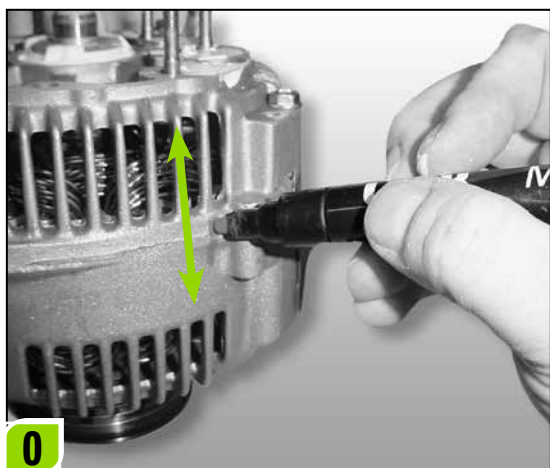

**0**



**1 ▶ 6 + 7 ▶ 14 + 15 ▶ 19**

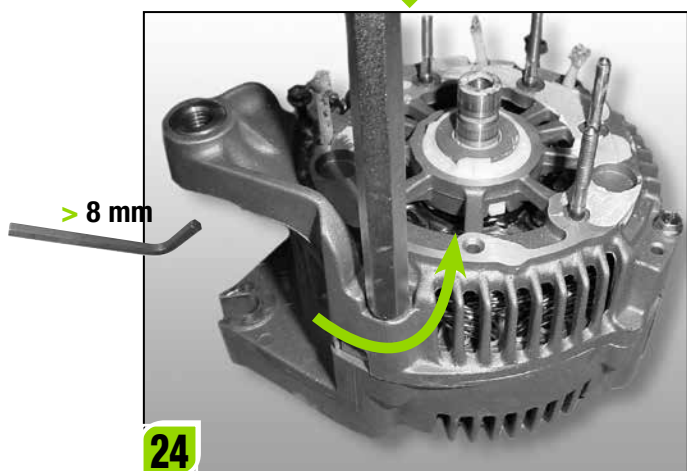

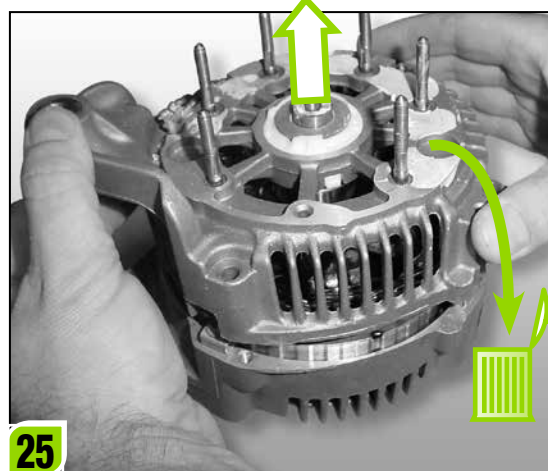

**24**

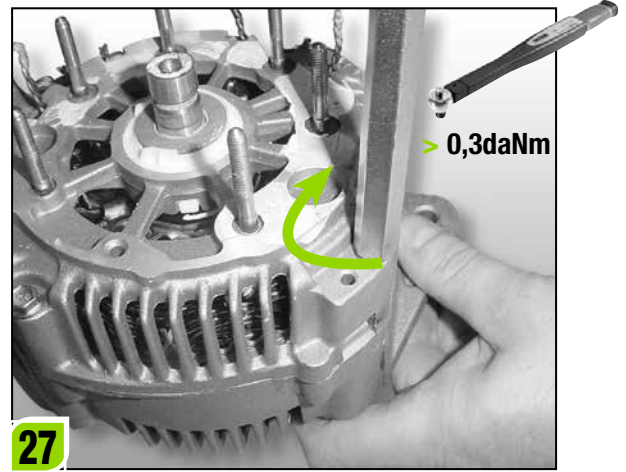
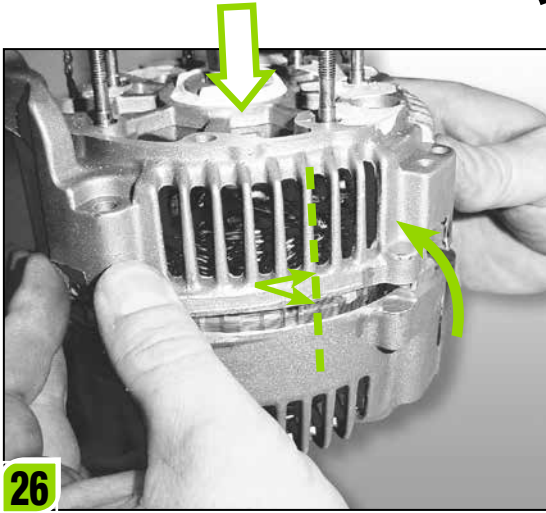

**25**





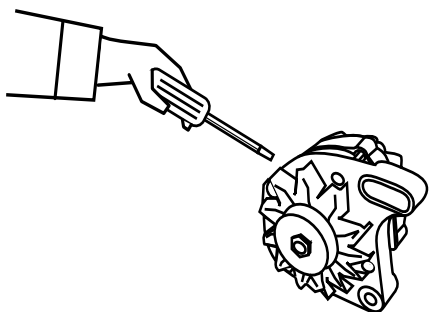

 **H ▶ T + A ▶ G**

 

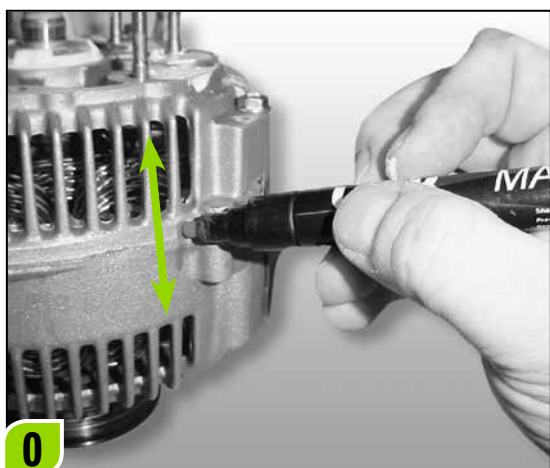

Rear Bracket • Palier arrière  
 Tapa trasera • Tampa traseira  
 Supporto posteriore • Achterste behuizing  
 Hinteres Lagerschild • Tylna obudowa  
 Arka karak • Задняя скоба/кронштейн



**1 ▶ 6 + 7 ▶ 14 + 15 ▶ 19**  

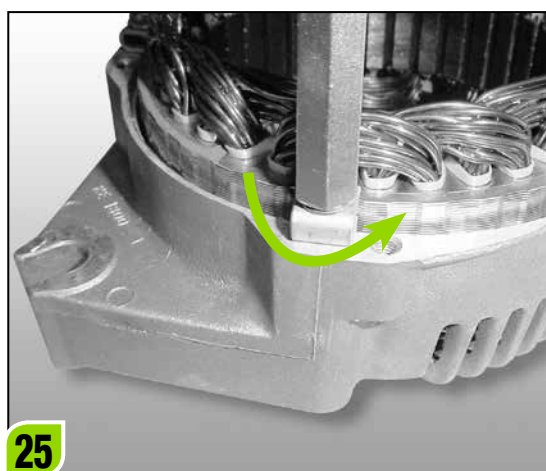
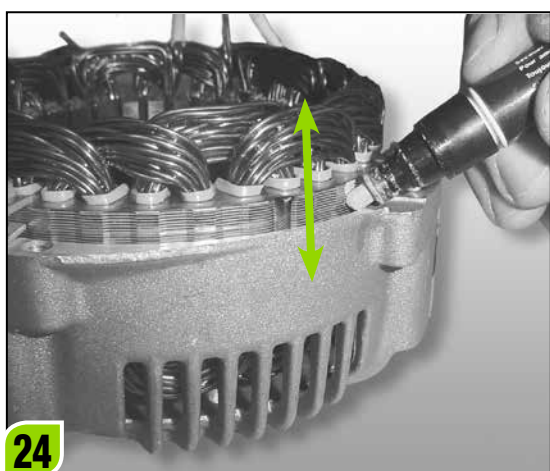

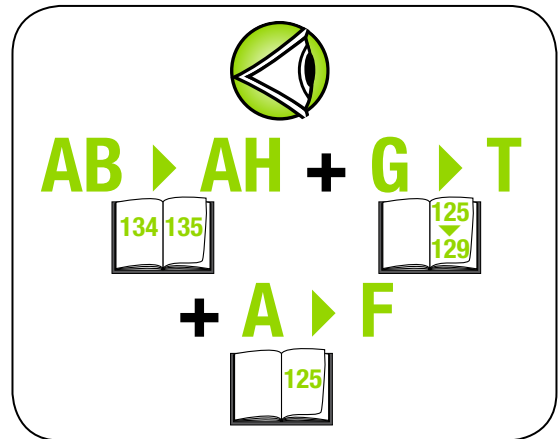
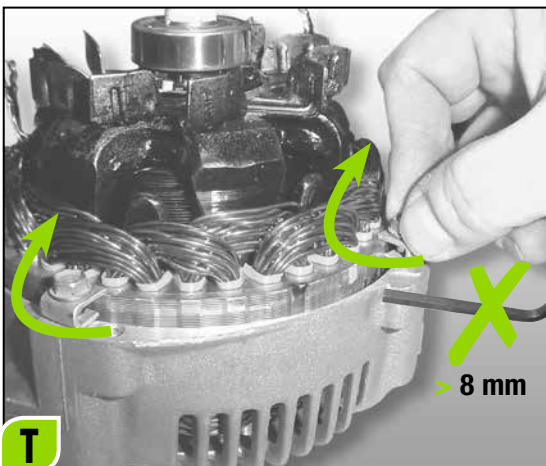
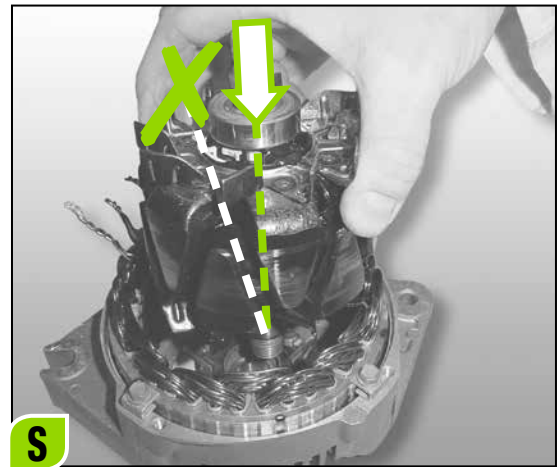
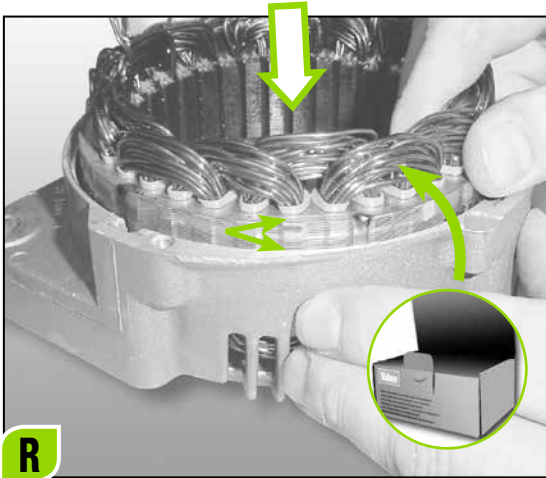
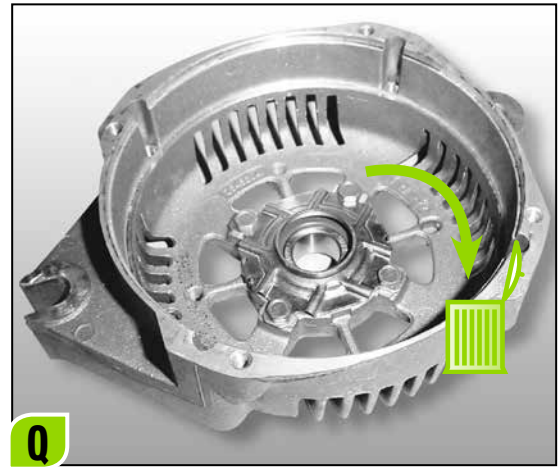
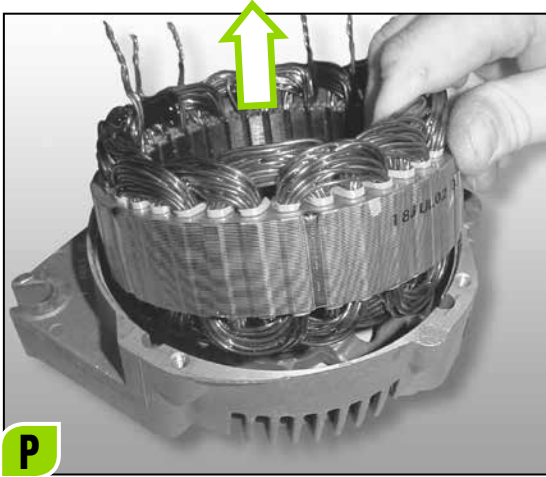



# Fitting instruction

FR Notice de montage SP Instrucciones de montaje PT Instruções de instalação IT istruzioni di montaggio NL Montage-instructies  
DE Montageanleitung PL Instrukcja montażu RU Инструкция по установке TR Montaj talimatları BR Instruções de instalação



## Disconnect the battery

FR Déconnectez la batterie  
SP Desconectar la batería  
PT Desligar a bateria  
IT Staccare la batteria  
NL Koppel de accu los  
DE Batterie abklemmen  
PL Odłączyć akumulator.  
TR Akünün bağlantısını kesin  
RU Отсоедините аккумуляторную батарею  
BR Desligar a bateria

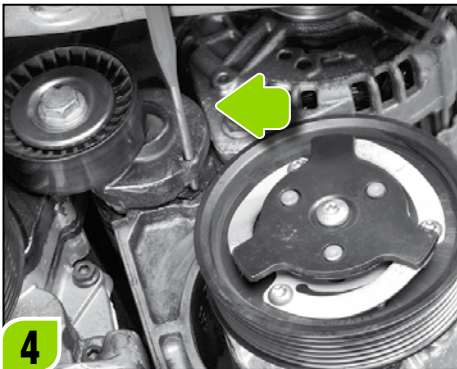
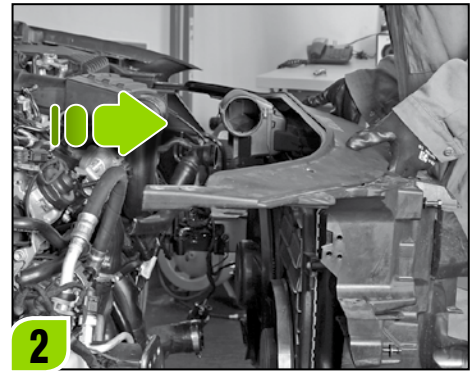

## Lock the tensioner

FR Bloquez le tendeur de la courroie  
SP Bloquear el tensor  
PT Bloquear o tensor  
IT Bloccare il tenditore  
NL Zet de riemspanner vast  
DE Spanner verriegeln  
PL Zablokować napinacz.  
TR Gergi mekanizmasını kilitleyin  
RU Зabloкyируйте натяжной механизм  
PT Bloquear o tensor

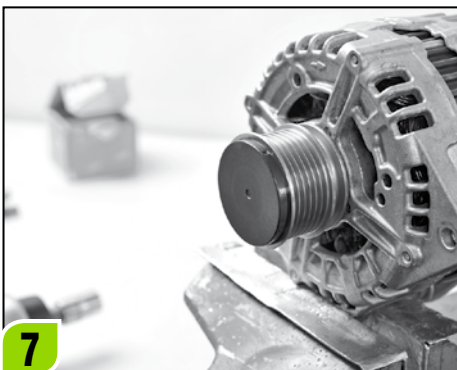
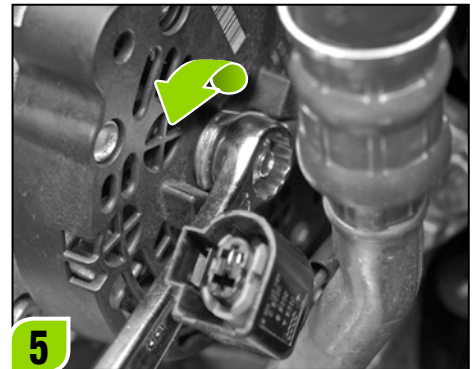

## Set the alternator on a support (clamps)

FR Fixez fermement l'alternateur  
SP Colocar el alternador en el banco  
PT Instalar o alternador num suporte (braçadeiras)  
IT Posare l'alternatore su un supporto (morsetti)  
NL Zet de dynamo in een bankschroef  
DE Lichtmaschine auf einer Abstützung (Klemmen) absetzen  
PL Umieścić alternator w uchwycie (klamrach).  
TR Alternatörü destek üzerine alin  
RU Установите генератор на опору (в тиски станка)  
BR Instalar o alternador num suporte (braçadeiras)

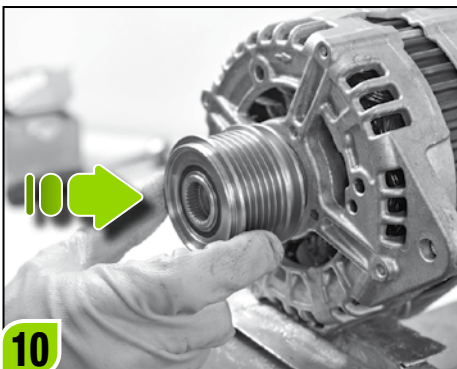
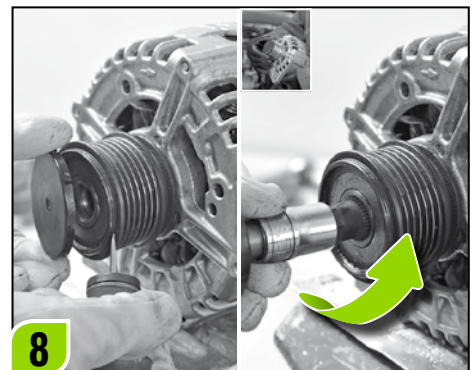

## Fit the new pulley using the tool

FR Mettre en place la nouvelle poulie  
SP Acoplar la nueva polea con el uso de la herramienta  
PT Depositar a polia nova utilizando a ferramenta  
IT Appoggiare la nuova puleggia utilizzando l'utensile  
NL Plaats de nieuwe poelie met het gereedschap  
DE Neue Riemenscheibe mit Hilfe des Werkzeugs einsetzen  
PL Założyć nowe koło pasowe przy użyciu narzędzia.  
TR Takım kullanarak yeni kasnağı yerine takın.  
RU Установите новый шкив с помощью инструмента  
BR Depositar a polia nova utilizando a ferramenta

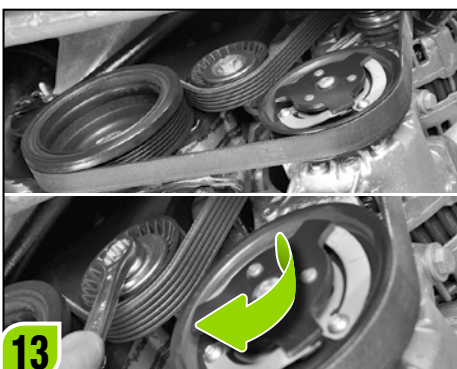
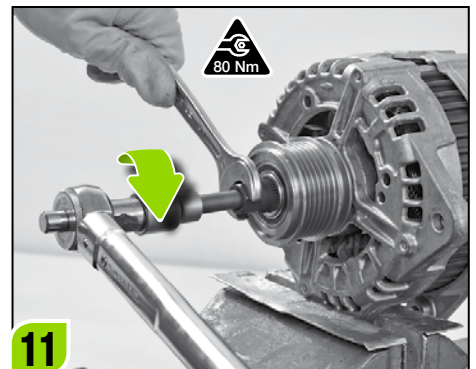

## Reposition the belt and tension it with the roller

FR Repositionner la courroie et la mettre sous tension via le galet tendeur  
SP Volver a colocar la correa y tensarla con el rodillo tensor  
PT Reposicionar a correia e pô-la sob tensão com o rolete  
IT Riposizionare la cinghia e tenderla con il cilindro  
NL Plaats de riem terug en zet deze met de riemspanner op de juiste spanning  
DE Riemen neu positionieren und mit der Rolle anziehen  
PL Założyć pas i naprężyć go za pomocą rolki.  
TR Kayışı ve gergisini yerleştirin  
RU Снова установите ремень и натяните его с помощью ролика  
BR Reposicionar a correia e pô-la sob tensão com o rolete

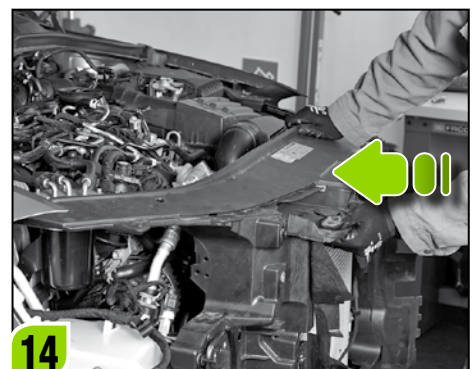



## Remove parts to get the access to the alternator

- FR Libérez l'accès à l'alternateur
- SP Retirar los accesorios para acceder al alternador
- PT Remover as peças para obter acesso ao alternador
- IT Togliere i componenti per accedere all'alternatore
- NL Verwijder eventueel onderdelen om bij de dynamo te kunnen komen
- DE Teile entfernen, um Zugang zur Lichtmaschine zu erhalten
- PL Zdemontować części, aby uzyskać dostęp do alternatora.
- TR Alternatöre eri mek için gerekli parçaları çıkarın
- RU Снимите компоненты, чтобы получить доступ к генератору
- BR Remover as peças para obter acesso ao alternador

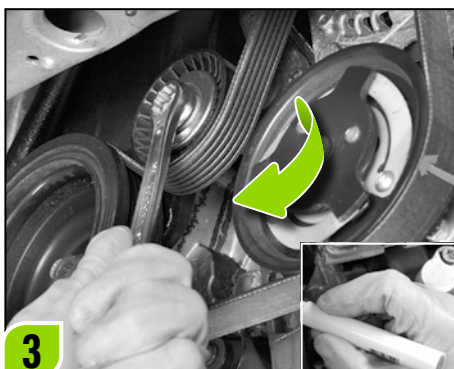

## Relieve tension on the belt and note the direction of travel of the belt

- FR Détendre la courroie et notez le sens de rotation
- SP Aflojar la correa y tomar nota del sentido de giro de la correa
- PT Soltar a tensão da correia e anotar a direcção de movimento da correia
- IT Allentare la cinghia e prendere nota del senso di movimento della cinghia
- NL Maak de aandrijfriem los en onthoud in welke richting deze draait
- DE Riemen entspannen und Laufrichtung des Riemens vermerken
- PL Poluzować pas i zapamiętać kierunek pracy pasa.
- TR Kayışı serbest bırakın ve kayış hareket yönüne dikkat edin
- RU Ослабьте ремень и зафиксируйте направление движения ремня
- BR Soltar a tensão da correia e anotar a direcção de movimento da correia

## Disconnect electrical connection on the alternator and remove the screws fixing the alternator

- FR Déconnectez les liaisons électriques et les vis de fixation de l'alternateur
- SP Desconectar las conexiones eléctricas del alternador y desmontar los tornillos que lo fijan
- PT Desligar electricamente o alternador e remover os parafusos que fixam o alternador
- IT Scollegare elettricamente l'alternatore e togliere le viti che fissano l'alternatore
- NL Maak de elektrische aansluitingen van de dynamo los en draai de dynamo los
- DE Lichtmaschine elektrisch trennen und Befestigungsschrauben der Lichtmaschine entfernen
- PL Odłączyć połączenia elektryczne alternatora i wykręcić jego śruby mocujące.
- TR Alternatörün elektriksiz olarak bağlantısını kesin ve alternatörü sabitleyen vidaları çıkarın (aracın kullanım kitapçığına uygun olarak)
- RU Отключите электрическое соединение генератора и открутите болты, с помощью которых он закреплен
- BR Desligar electricamente o alternador e remover os parafusos que fixam o alternador

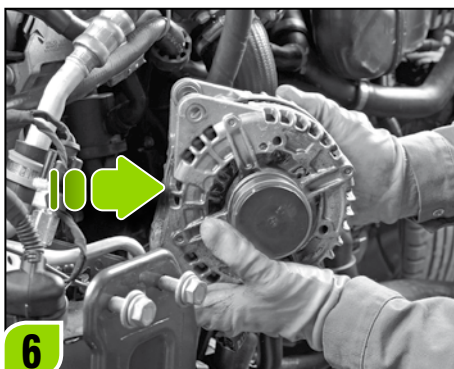

## Remove the alternator

- FR Extraire l'alternateur
- SP Desmontar el alternador
- PT Remover o alternador
- IT Togliere l'alternatore
- NL Verwijder de dynamo
- DE Lichtmaschine entfernen
- PL Wymontować alternator.
- TR Alternatörü çıkarın
- RU Снимите генератор
- BR Remover o alternador

## Remove the protective cap and unlock the pulley with the tool

- FR Enlevez le couvercle de l'ancienne poulie et desserez cette dernière à l'aide d'une clef à choc et de la douille appropriée
- SP Desmontar la tapa protectora frontal y desbloquear la polea con la herramienta
- PT Remover a cobertura de protecção e desbloquear a polia com a ferramenta
- IT Togliere il coperchio protettivo e sbloccare la puleggia con l'utensile
- NL Verwijder de beschermingskap en maak de poelie los met het gereedschap
- DE Schutzkappe entfernen und Riemenscheibe mit dem Werkzeug entriegeln
- PL Zdjąć osłonę ochronną i odblokować koło pasowe narzędziem.
- TR Korumucu kapağı çıkarın ve kasnağı alet kullanılarak serbest hale getirin
- RU Снимите защитную крышку и открутите шкив с помощью инструмента
- BR Remover a cobertura de protecção e desbloquear a polia com a ferramenta

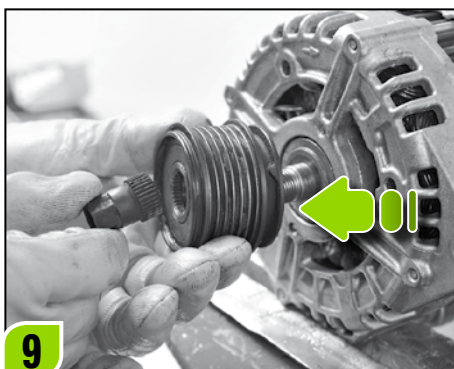

## Remove the former pulley using the tool

- FR Extraire l'ancienne poulie
- SP Retirar la polea con el uso de la herramienta
- PT Depositar a polia anterior utilizando a ferramenta
- IT Deposare la vecchia puleggia utilizzando l'utensile
- NL Verwijder de oude poelie met het gereedschap
- DE Alte Riemenscheibe mit Hilfe des Werkzeugs entfernen
- PL Odkładanie dotychczasowego koła pasowego przy użyciu narzędzia
- TR Gereklı takımları kullanarak eski kasnağı yerinden sökün
- RU Снимите и отложите ранее использованный шкив с помощью инструмента
- BR Depositar a polia anterior utilizando a ferramenta

## Tighten the pulley to the correct torque and fit the new cap

- FR Serrer la poulie au couple préconisé et mettre le nouveau couvercle
- SP Aplicar el par de apriete correcto en la polea y colocar la nueva tapa frontal
- PT Apertar a polia com o grau correcto e colocar uma tampa nova
- IT Serrare la puleggia fino al grado corretto e posizionare il nuovo coperchio
- NL Draai de bouten van de poelie tot de aanbevolen waarde vast en monteer de nieuwe kap
- DE Riemenscheibe im richtigen Winkel anziehen und neue Schutzkappe aufsetzen
- PL Dokręcić koło pasowe odpowiednim momentem i założyć nową osłonę.
- TR Kasnağı doğru miktarda sıkın ve yeni bir kapak takın
- RU Затяните шкив на необходимом уровне и установите новую крышку
- BR Apertar a polia com o grau correcto e colocar uma tampa nova

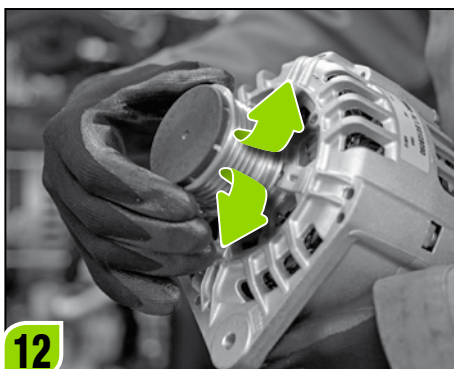

## Check the new Freewheel Pulley

- FR Vérifier la nouvelle poulie roue libre
- SP Revisar la nueva polea de rueda libre
- PT Verificar a nova polia de roda livre
- IT Controllare la nuova puleggia a ruota libera
- NL Controleer de nieuwe vrijlooppoelie
- DE Neuen Generatorfreilauf prüfen
- PL Sprawdzić działanie nowego wolnego koła pasowego.
- TR Yeni rulmanlı kasnağı kontrol edin
- RU Проконтролируйте новый шкив свободного хода
- BR Verificar a nova polia de roda livre

## Refit the components removed in step 2

- FR Remonter les composants déposés en étape 2
- SP Volver a instalar los componentes que se retiraron en el paso 2
- PT Voltar a instalar os componentes retirados no passo 2
- IT Installare nuovamente i componenti tolti nella fase 2
- NL Monteer de in stap 2 verwijderde onderdelen opnieuw
- DE Die in Schritt 2 entfernten Komponenten wieder montieren
- PL Zamontować podzespoły zdemontowane w punkcie 2.
- TR 2. adımda çıkarılan parçaları geri takın
- RU Установите на место компоненты, демонтированные в рамках шага 2
- BR Voltar a instalar os componentes retirados no passo 2



## Reconnect the battery

- FR Reconnecter la batterie
- SP Volver a conectar la batería
- PT Voltar a ligar a bateria
- IT Ricollegare la batteria
- NL Sluit de accu opnieuw aan
- DE Batterie wieder anschließen
- PL Podłączyć akumulator.
- TR Aküyü tekrar takın
- RU Присоедините аккумуляторную батарею
- BR Voltar a ligar a bateria

---

NOTES NOTES NOTAS NOTAS NOTE NOTITIES NOTIZEN NOTATAKI NOT ПРИМЕЧАНИЯ POZNAMKY

---

 → **Valeo** \_\_\_\_\_ 145

  →  \_\_\_\_\_ 159



  → **NEW** \_\_\_\_\_ 169

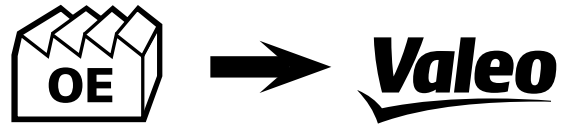

  → **Valeo**  \_\_\_\_\_ 179











	
<b>ACMAT</b>	
N110337B	593188
N110350B	182169
<b>AGCO</b>	
4287016M1	599310
4287018M1	599312
4289357M1	599315
4356716M1	599313
4376754M1	599314
4376757M1	599311
<b>ALSIA</b>	
16296123	594104
<b>ARMEE S.C.A.</b>	
62920143804910	92955
62920143804911	92956
62920143990104	97486
62920143991250	92953
63110144231955	105299
64140144121643	101126
65340143989573	100478
65365143989480	77973
65365144081106	300835
65910143990107	103744
65977144110881	300722
66115143989568	96442
<b>AUDI</b>	
595629	595629
28903461	593990
30903181	590761
30903193	592943
47903803	593362
57911255	594500
58903119	593711
68911791	594371
78903359	592917
022903119C	599327
022903119D	593490
028903803F	593131
02A911287B	594391
02A911365	594390
02M911115P	595623
02M911211	595624
02M911255K	595625
02M911311F	595621
02M911335M	595622
02M911361	595628



	
<b>AUDI (.../...)</b>	
02Z911287	594617
02Z911287B	595617
030903119C	592920
030903213B	593298
030903213C	593150
030903351A	592832
030903351B	593279
030903506D	593414
030903537A	593644
034903119J	593697
036903119M	593868
037903359C	592915
037903359D	593328
037903359E	593366
03C903119E	595356
03D903119	593615
03G903803C	595457
03I903023	599205
045903119A	599248
058903119A	593719
059903119D	593900
059903119K	595308
059903119L	599143
059903213E	595297
059903351B	593580
059903506A	593979
059903506B	593415
059903506C	595455
059903537A	593627
059903537B	593642
059903537C	595453
059903803G	595458
059903803K	599141
059903803L	599183
068911115P	594372
068911255AA	594495
068911287J	594370
068911303H	594373
068911311Q	594112
068911320A	594369
068911335L	594136
06B903119	593592
06B903119A	593494
06B903119B	593778
06B903213	593567
06B903213B	593569
06B903213C	593926
06B903351	593579



	
<b>AUDI (.../...)</b>	
06B903351	593579
06B903351B	593591
06B903506	593372
06B903506B	593547
06B903506C	593393
06B903506D	593439
06B903506E	593503
06B903537	593628
06B903537B	593630
06B903537C	593659
06B903803B	599316
06C903506	593542
06D903506	593855
06D903537	593856
06E903119P	593920
06E903119S	599137
06E903506	595459
06E903506A	593924
06E903537	593922
06E903803T	599234
06F903213B	593285
06F903213C	593798
06F903506	593852
06F903506A	593824
06F903506C	593814
06F903506D	593899
06F903537	593854
06F903537A	593827
06F903537B	593815
06F903537D	593901
077903119C	593594
077911287A	594624
078903119C	593696
078903119H	593593
078903193B	592949
079903803F	599235
<b>BMW</b>	
12314466273	588036
12317516099	588056
12317516103	588036
12317516105	588055
12317536960	588055
12317550001	588055
12317552352	588056
12317552353	588036
12317560483	588036
12317561555	588048



	
<b>BMW (.../...)</b>	
12317570152	588055
12317576515	588048
12318574051-00	599326
1244607-00	594045
1244609-00	594068
1244611-00	594084
1244616-00	594072
1244680	594022
1244682	594033
1244684-00	594127
1247306	593699
1318157-01	595260
1432965-02	593333
1432989	593726
1435940	593727
1713839-01	593347
1730595	592955
1730601	592952
1735745	592947
1739193-01	592781
1739196	592699
1739198	592835
1739199	592896
1739200	592897
1739422	593695
1739435-01	593258
1747220	593694
2244166	592919
2244637	592854
2245588	593708
2247390	593728
2249968	593406
2306015-01	594387
2306168-01	594173
2306169-01	594255
2306239-01	594284
7501751-02	593870
7505926	593606
7505927	593607
7512731	593622
7516109	593537
7516715-02	593551
7521262	593789
7525439-01	593879
7536660	593873
7540159	593917
7543917-01	595211
7551153-00	593423

	
<b>BMW (.../...)</b>	
7547082-02	593984
7551153-00	593423
7560990-01	595264
7561001-01	595269
7570152-01	595203
7575346-01	595469
7576515-01	595317
7603775-01	599232
7603776-01	595464
7603777-01	599088
7615483-01	599149
7787355-01	594467
7788246-01	593406
7789982-01	593794
7789982-01	595272
7792020-02	595278
7792094-01	593839
7797662-01	593793
7797662-01	593793
7801125-01	595281
7808026-01	595462
7836450-00	594454
7847517-01	599221
8510087-01	595446
8510088-01	599095
8510089-01	595348
8510090-01	599102
8510092-01	599101
8515518-01	599212
8515519-01	599335
8515519-01	599217
<b>BUKH RECHANGE</b>	
612H0252	102659
<b>CHEVROLET</b>	
13258483	588028
93743440	588068
<b>CITROEN</b>	
58210	101923
572073	100273
572753	593146
572759	593149
572761	593285
5720A1	593159
5725F7	592866
5725G2	592905
574400	593202



	
<b>CITROEN (.../...)</b>	
574661	593282
5744C6	592878
5744D1	593163
576191	593350
581707	594141
581714	594176
582783	594116
5820A4	594115
5821D9	594112
5828A0	594129
583661	594183
583662	594181
5835A6	594136
5835C4	594214
585581	594262
585584	594255
75526521	300696
75526989	97804
9405727378	590625
9405744548	105754
9405807228	102380
9405817028	594019
9405827788	182050
9405827818	594084
9405828888	594072
9405828898	594070
9405835568	99931
9405835888	182052
9405835988	182176
9405836388	105489
9405836488	594045
9405855738	182048
9405855778	594068
95495930	103487
95588211	182461
95618181	182065
95618183	594066
95618194	182063
95618200	182058
95618207	182060
95619446	181404
95619448	182051
95619717	590542
95624492	594057
95624493	594039
95644498	593350
95644500	592851
95644504	592834

	
<b>CITROEN (.../...)</b>	
95644501	592854
95644503	592821
95644504	592834
95644506	592848
95644508	592853
95644511	592831
95653199	100930
95656637	594098
95659577	594132
9790253808	182053
9790260708	594029
<b>DACIA</b>	
231029449R	595248
231086175R	593570
231180026R	593632
231201734R	592866
232304025R	595247
7701208248	593935
<b>FIAT</b>	
77362459	594419
77362651	593147
77362652	593158
77362716	593859
77362717	593865
77362720	593864
77362721	593860
77362730	594650
77362731	594644
77362732	594646
77362733	594648
77362734	594651
77362735	594645
77362736	594647
77363273	593532
77363303	593521
77363326	594613
77363468	593832
77363784	595222
77363786	595221
77363910	594636
77363911	594317
77363954	599223
77363960	593804
77364443	594449
77364444	594385
77364795	595310
77364796	599316
77364873	595354
77365416	593890
77366189	599197
77366190	599204
<b>FORD</b>	
AS6910335AA	595413
AS6910344BA	595392
BA6T10304AA	595321
BA6T10316AA	599182
<b>FRIGIKING</b>	
30-60050-20	593191
30-60050-22	104269
50-60151-00	507073
7101532	592841



	
<b>FIAT (.../...)</b>	
77364873	595354
77365416	593890
77366189	599197
77366190	599204
9941391	96879
9941740	182175
9941741	182177
9941743	182051
9941744	182048
9941745	182050
9945012	594084
9946190	594183
9946195	593138
9946196	593701
9948560	594127
9948723	594185
9948724	594188
9948725	594353
9948727	594210
9948892	594409
9948893	594416
9948894	594242
9948895	594414
9948896	594377
9949116	593159
9949117	593404
9949118	593736
9949131	593282
9949256	593434
9949257	593447
9949266	593608
9949433	593350
9949436	593202
9949438	594459
9949440	594287
9949507	593754
9949510	593146
9949511	592834
9949514	592854
9949518	593284
9949520	593620
9949521	593288
9949628	593419
9949630	593358
9949631	593420
9949632	593519
9949633	593421
9949634	593559



	
<b>FIAT (.../...)</b>	
9949638	593558
9949639	593534
9949644	593613
77362459	594419
77362651	593147
77362652	593158
77362716	593859
77362717	593865
77362720	593864
77362721	593860
77362730	594650
77362731	594644
77362732	594646
77362733	594648
77362734	594651
77362735	594645
77362736	594647
77363273	593532
77363303	593521
77363326	594613
77363468	593832
77363784	595222
77363786	595221
77363910	594636
77363911	594317
77363954	599223
77363960	593804
77364443	594449
77364444	594385
77364795	595310
77364796	599316
77364873	595354
77365416	593890
77366189	599197
77366190	599204
<b>FORD</b>	
AS6910335AA	595413
AS6910344BA	595392
BA6T10304AA	595321
BA6T10316AA	599182
<b>FRIGIKING</b>	
30-60050-20	593191
30-60050-22	104269
50-60151-00	507073
7101532	592841







	
<b>GM</b>	
9118890	593342
9118891	593729
93190560	594773
<b>HATZ RUHSTORF</b>	
49053801502	182007
49053802502	593129
49053902502	593130
<b>HONDA</b>	
31208-P1J-E01	594317
31208-PDA-E01	594360
31210-P1J-E04	594357
31210-P1J-S01	594405
31210-P45-G61	594334
31230-P1J-E01	594255
31240-P1J-E01	594242
31251-PDA-E51	594358
31251PDAE510	594317
31252-P1J-E01	594318
31252-PDA-E01	594364
31252-PMH-G01	594445
<b>HYUNDAI</b>	
36120-23150	594322
36131-23150	594255
36137-23150	594242
36145-23150	594247
36155-23150	594323
36160-23150	594236
36169-23150	594317
37321-37250	593595
37350-37150	593579
37370-37250	593389
37321-37400	593886
37330-37400	593889
37340-37400	593888
37360-37400	593885
37370-37400	593884
<b>IRIBUS</b>	
503135473	594075
503141185	188331
503141187	188320
<b>IVECO</b>	
1905394	592858
1905395	592857
1905489	592905
93192395	590640



	
<b>IVECO (.../...)</b>	
93192396	593264
93192397	593277
93192398	593181
93192400	100995
98482417	592703
99448818	593217
99448819	593216
9949256	593434
9949259	593290
9949270	593609
<b>JOHN DEERE</b>	
R91452	593256
RE63196	594308
RE63197	594309
RE63198	594310
<b>KHD</b>	
1180686	182120
1180923	593835
1318360	592858
1318619	300665
1319485	593199
1321424	518611
<b>KIA</b>	
0K554-18-W11	588073
37321-25-201	588094
37321-4X-210	588073
37321-4X-300	588073
37321-4X-301	588073
37322-27-010	588046
37322-27-012	588046
37322-2A-000	588043
37322-2A-110	588043
37322-2A-500	588043
37322-4A-000	588075
37322-4A-001	588075
37322-4A002	588075
373222A500	595286
373402A500	593800
37370-2A600C	599160
373702A500	595283
373702A601	599269
373802A500	595284
373802A650	599201
<b>LAND ROVER</b>	
YLW000010	593347

	
<b>LOMBARDINI</b>	
5041233	594087
6456039	594086
8150022	594084
<b>MASERATI</b>	
313453202	594127
<b>MASSEY FERGUSON</b>	
3900856M91	593191
3900857M91	593183
3900860M1	593222
3903318M91	593350
3903321M91	593382
3903322M1	593721
3903323M91	592854
3903324M91	593383
3903425M1	593219
4287016M1	599310
4376755M1	599315
4379089M1	599313
<b>MAZDA</b>	
LF18-18-330	588058
LF18-18-330A	588058
LF18-18-W11A	588058
LW18-18-W11	588058
RF5C-18-330	588053
RF5C-18-330A	588053
RF5C-18-W11	588053
RF5C-18-W11A	588053
U201-18-W10	588057
<b>MERCEDES BENZ</b>	
A0001500024	182048
A0001500050	592854
A0001500224	594281
A0001500255	592792
A0001500324	594259
A0001500449	594282
A0001500549	594242
A0001500624	594255
A0001500724	594460
A0001500824	594462
A0001515615	594278
A0001518555	594157
A0001519455	594277
A0001519755	594354
A0001544515	592808
A0001546325	592826



	
<b>MERCEDES BENZ (.../...)</b>	
A0001550201	104809
A0011510714	594261
A0011510914	594351
A0011511113	594152
A0011511713	594279
A0011512013	594248
A0011512413	594345
A0011513014	594404
A0011513313	594185
A0011513913	594252
A0011514613	594644
A0011514713	594436
A0011516413	595698
A0011516513	594702
A0011517814	595700
A0011518214	595737
A0011518314	595736
A0011518414	595738
A0011520510	594266
A0011522610	594271
A0011525010	594447
A0011525510	594401
A0011525610	594461
A0011525710	594463
A0011527510	594724
A0011527610	594727
A0011540016	592838
A0011550218	592904
A0011569001	593233
A0019901850	590761
A0021521810	595699
A0021521910	595701
A0021522010	595702
A0031540306	593131
A0031541106	593191
A0031541606	593390
A0031541806	593395
A0031543806	593350
A0031543906	593779
A0031544006	593780
A0031544506	593874
A0031544606	593948
A0031544706	593975
A0031544806	593970
A0031546406	595243
A0031547806	595387
A0031548206	595324
A0041540706	599127

	
<b>MERCEDES BENZ (.../...)</b>	
A0041540906	599083
A0041541206	599125
A0041541306	599107
A0041541406	599128
A0041541706	599241
A0041541806	599307
A0041541906	599308
A0041542006	599309
A0041542006	599251
A0041542506	599296
A0041542606	599300
A0041542706	599306
A0041542806	599304
A0041542906	599302
A0041543106	599317
A0041543306	599303
A0041543406	599301
A0041543606	599341
A0041543706	599339
A0069810525	102130
A0079818025	592866
A1111550415	593718
A1111550415	593598
A1121550315	593605
A1191550215	593597
A1661550015	593724
A1661550115	593730
A1661550115	593604
A2661550015	593950
A2661550115	595386
A2711550215	595258
A2721550215	595368
A2781500060	599105
A6041500060	593495
A6041550015	592898
A6041550015	593596
A6401500660	599104
A6421500660	593960
A6421500760	595239
A6421550015	599184
A6461550115	595323
A6511550015	599245
<b>MERCEDES-BENZ</b>	
A1661550215	588083
A2711550016	588060
A2711550115	588060
A2711550215	588052

	
<b>MERCEDES-BENZ (.../...)</b>	
A2781500060	588031
A6021500060	588044
A6041500060	588044
A6041500160	588068
A6041500360	588044
A6041500460	588078
A6041500560	588068
A6041500660	588078
A6111500160	588039
A6111500360	588030
A6111501650	588030
A6111550015	588030
A6111550215	588039
A6111550315	588020
A6111550415	588030
A6111550515	588020
A6111550715	588020
A6281500060	588072
A6281550015	588105
A6291500060	588090
A6291500160	588100
A6401500160	588025
A6401500360	588025
A6401500560	588025
A6401500660	588025
A6401500760	588025
A6401500960	588025
A6421500360	588049
A6421500660	588049
A6421500760	588093
A6421500860	588072
A6461500260	588019
A6461500360	588019
A6461550115	588031
A6481550015	588019
A6681550015	588085
A6681550715	588085
<b>MINI</b>	
12317561555	588048
12317576515	588048
<b>MITSUBISHI</b>	
1800A061	588087
30662352	594262
A252C564FE	588069
A628X91171	588058
A628X92071	588053
MN960267	588025

	
<b>MITSUBISHI (.../...)</b>	
S30662351	594431
S30662352	594262
S30662353	594185
S30662354	594327
S345812	592922
S882416	593310
SMD620979	594236
SMD620980	594247
SMD620981	594269
SMD620982	594258
SMD620983	594255
SMD620984	594257
SMD620985	594242
<b>MOTO GUZZI</b>	
305305100	594035
305305120	594084
<b>MOTOROP</b>	
12980170001	96894
327980090001	590640
<b>NANNI MARINE</b>	
48200821	53457
<b>NISSAN</b>	
23108-AX600	593820
23118-AX600	593821
23118-AX62A	595216
23120-AX600	592866
23124-AX600	593819
23124-AX62A	595215
23150-2W200	588079
23150-2W20A	588079
23150-2W20B	588079
23150-AX600	593822
23150-AX62B	595257
23151-00Q0A	588010
23151-00Q0A	588029
23151-00Q0A	588038
23151-00Q0B	588010
23151-00Q0B	588029
23151-00Q0B	588038
23151-6N200	588092
23151-6N20A	588092
23151-6N20B	588092
23151-EB301	588069
23151-EB30A	588069
23151-EL010	588081



	
<b>NISSAN (.../...)</b>	
23151-JD20A	588081
23151-JG71B	588063
23215-AX600	593818
23215-AX610	593915
233025X20A	595619
23302JG70A	594750
23322-AX000	594289
23322JG70A	594748
23322JG71A	595620
23343-AX000	594481
23343-AX010	594452
233431BY0A	595618
233435X20A	595653
23343JG71A	595654
23354-AX000	594451
23354-AX00C	595733
23354JG70A	594747
23378-AX000	594290
A660C-300BX	588034
A660C-300EX	588034
<b>OPEL</b>	
1204177	588028
1204376	588070
1204378	588095
1204392	588006
1204412	588007
1204413	588009
1204517	588006
4417573	588038
4417574	588029
4805492	588068
55186280	588006
6204229	588012
6204286	588006
6204286	588012
6204889	588021
9192954	594374
9192955	594376
90421771	594108
90421772	594117
90421773	594130
90421774	594084
90442497	594105
90540479	594068
90543809	594233
90543810	594252
90543811	594263



	
<b>OPEL (.../...)</b>	
93178274	593890
93190560	594773
93190561	594774
93190563	594645
93190569	594644
93192631	593860
93175986	588095
93182514	588009
93182514	588095
93190867	588038
93190868	588029
93743440	588068
<b>OTOKAR</b>	
518688	518688
590566	590566
590613	590613
590629	590629
590640	590640
592752	592752
593563	593563
<b>PANHARD</b>	
535451	97486
535453	101126
535454	103761
535455	97482
535457	103757
535458	77973
535459	97483
535464	100478
536689	103744
541035	590582
541037	102589
541039	92967
541040	102130
543309	517012
611332	92955
714312	92956
<b>PCM</b>	
5821D9	594112
<b>PEGASO</b>	
175952	102589
175953	590640
175954	104269
175958	592703



 OE	Valeo
<b>PEUGEOT</b>	
570626	100478
572069	97486
572072	101025
572073	100273
572095	592834
572096	592831
5720A1	593159
572562	592905
5725F7	592866
572711	300694
572749	592821
572753	593146
572756	593147
572759	593149
572761	593285
573379	592851
573381	592853
574400	593202
574445	103756
5744A2	592878
5744C6	592878
5744C9	592848
5744D1	593163
574660	592854
574661	593282
576191	593350
580721	102851
581707	594141
581714	594176
582076	102854
5820A1	182051
5820A4	594115
58210	101923
5821A9	182053
5821C2	182175
5821D9	594112
582624	182063
582778	182050
582781	594084
582783	594116
582877	182065
582888	594072
582889	594070
582894	594132
5828A0	594129
583564	102846
583588	182052
5835A0	594029



 OE	Valeo
<b>PEUGEOT (.../...)</b>	
5835A6	594136
5835C4	594214
583653	594098
583661	594183
583662	594181
585573	182048
585577	594068
585581	594262
585584	594255
<b>PORSCHE</b>	
91160391301	300871
95560315200	588096
99660315250	588074
99760315400	588074
<b>PSA</b>	
572073	100273
572095	592834
572096	592831
5720A1	593159
5720A2	593286
5720A9	593358
5720C0	593161
572572	593359
5725F7	592866
5725G2	592905
5725G2	592905
572749	592821
572753	593146
572756	593147
572759	593149
572761	593285
572761	593285
572781	593967
573379	592851
573381	592853
573393	593288
573393	593288
573397	593377
574400	593202
574400	593287
5744C6	592878
5744C9	592848
5744D1	593163
5744F3	593297
5744F4	593293
5744F6	593337
5744G0	593420



 OE	Valeo
<b>PSA (.../...)</b>	
5744G1	593435
5744G2	593530
5744G3	593526
5744H0	595208
5744H1	593478
5744H5	593803
5744H7	593447
574660	592854
574661	593282
576191	593350
576195	593284
5761A2	593290
5761A5	593375
5761C1	593529
5761C2	593532
5761C5	593534
581707	594141
581714	594176
581716	594237
581717	594187
581717	594187
581723	594283
581725	594412
5820A1	182051
5820A4	594115
5820A4	594115
5820A9	594241
5820A9	594241
5821A9	182053
5821C2	182175
5821D9	594112
5821D9	594112
5821G5	594650
5825F0	594290
5825F0	594290
5825F1	594479
5825F2	594386
5825F3	594634
582778	182050
582781	594084
582783	594116
582785	594210
582789	594242
582888	594072
582889	594070
582894	594132
5828A0	594129
5828A8	594367



	
<b>PSA (.../...)</b>	
5828C1	594424
5828C3	594418
583500	594303
583588	182052
5835A0	594029
5835A6	594136
5835C3	594185
5835C4	594214
5835F0	594419
5835F5	594287
5835F7	594382
5835F8	594631
5835F9	594644
583653	594098
583653	594098
583658	594188
583661	594183
583662	594181
583675	594365
583683	594348
583685	594449
585573	182048
585577	594068
585581	594262
585584	594255
585587	594304
585596	594289
585598	594466
585599	594645
<b>RENAULT</b>	
231201734R	592866
7700110616	588004
7700110616	588023
7701026346	106009
7701027015	182458
7701027016	99931
7701027401	100930
7701027481	101582
7701028668	182463
7701029934	92968
7701030118	593910
7701030810	518688
7701030815	300821
7701031089	590660
7701031738	180593
7701031738	103543
7701032315	105135



	
<b>RENAULT (.../...)</b>	
7701032826	105489
7701032827	182047
7701033171	590558
7701033654	541137
7701033865	590625
7701033866	592830
7701034104	592724
7701034189	594046
7701034838	300694
7701034945	592830
7701034955	594108
7701035388	594058
7701035410	592815
7701035560	594245
7701035561	594274
7701035562	594240
7701039296	594251
7701040421	594176
7701040423	594208
7701040831	594252
7701041247	594112
7701041248	594185
7701041250	594187
7701041251	594186
7701041254	594210
7701042665	594288
7701043359	593290
7701043901	593310
7701044722	593204
7701044953	593324
7701045012	594188
7701047338	594345
7701047342	594351
7701047782	594383
7701047959	594388
7701049499	594410
7701049500	593411
7701051534	593408
7701054970	594450
7701055052	593546
7701055871	588010
7701057359	593689
7701057360	593830
7701066401	588102
7701202374	182063
7701202375	182065
7701202545	594066
7701203151	594084



	
<b>RENAULT (.../...)</b>	
7701203152	594060
7701203877	592846
7701203879	592854
7701204633	594254
7701204829	594255
7701204928	594127
7701204930	594115
7701205777	594327
7701206321	594386
7701207240	594242
7701207379	594383
7701207380	594431
7701207381	594438
7701207382	594355
7701207383	594411
7701207384	594290
7701207385	594287
7701207388	594289
7701207389	594436
7701207390	594262
7701207394	594443
7701207395	594423
7701207807	588010
7701208248	593935
7701208249	593936
7701208250	593937
7701208251	593938
7701208283	593939
7701476465	588034
7701477502	588010
7701477507	588038
7701477508	588029
7701477508	588010
7701477689	588004
8200113636	588034
8200113636	588004
8200489514	588027
8200584039	588038
<b>RENAULT AGRICULTURE</b>	
6005000253	593254
6005000261	593255
6005003000	592884
6005011004	593191
6005011006	593223
7701026589	101025
7701027401	100930
7701027408	100845



	
<b>RENAULT AGRICULTURE (.../...)</b>	
7701028009	590558
7701028016	92968
<b>RENAULT V.I.</b>	
5000084736	96480
5000288156	594075
5000296603	182169
5000803988	101054
5000804256	590663
5000804264	92953
5000804268	100478
5000804278	101344
5000807158	102589
5000813994	181142
5000814648	593193
5000815124	300835
5000821881	592736
5000821883	517012
5000824130	92967
5000824131	592789
5001013973	182055
5001013974	518689
5001013979	592752
5001013980	105604
5001825405	594193
5001831140	594220
5001833631	101868
5001833633	592857
5001853649	593400
5010146091	592703
5010217035	594202
5010306653	188320
5010306654	188331
7420367490	594652
7701016777	77973
7701024332	102659
7701026589	101025
7701029158	300694
7701029160	101932
7701029372	104809
7701201015	97804
7701202367	182060
873962	595588
<b>ROVER</b>	
PQR10064	97140
YLG10002	592673
YLW10006	182120

	
<b>SAAB</b>	
1204376	588070
12759596	588045
12786853	588070
5340393	588095
5543814	588095
93182514	588009
<b>SCANIA</b>	
1104939	105604
1109170	2102132
1118148	590640
1123786	102604
1123790	95390
1123792	518689
1304543	97482
1309875	592752
1404590	593721
1407959	594296
1407960	594286
1407961	594302
2099363	593716
308502	105299
308508	102589
326471	592858
326471	593224
327550	300665
327551	103440
330841	104269
330994	590564
369860	182055
369862	181295
387968	590566
389008	105617
<b>SKODA</b>	
03C903119 E	595356
06B903803B	599316
<b>SMART</b>	
A1321500933	599138
A1321501033	599139
<b>SMART (MCC)</b>	
A6401500360	588025
A6401500560	588025
A6401500660	588025
<b>SUZUKI</b>	
31171-79J00-000	588009
31191-67J00	594411



	
<b>SUZUKI (.../...)</b>	
31220-67J00	594262
31320-67J00-000	594185
31401T85E00000	593864
31410-68D00	593286
31514-68D00	593288
31580-69K00000	595228
31580T85E00000	593862
31582-68D00	592905
31582T85E00000	592866
31621-68D00	593499
31621-69K00000	593803
31621T85E00000	593859
31710-68D00	593285
31771-68D00	588015
31771-68D00	588017
31771-68D01	593907
31771-68D01	588015
31771-68D01	588017
31771-69K00000	593832
31771-85E00	588006
31771-85E00000	599223
32500-68D00	593284
32500-68D01	593532
32500T85E00000	593890
32800-68D00	593526
<b>TOYOTA</b>	
27403-0Y120	599209
27415-0L010	588082
27415-0L020	588057
27415-0L030	588082
27415-0L040	588057
27415-27011	588037
27415-30020	588082
27415-33010	588097
27702-0Q140	599162
28011-0R021	595732
28113-0R020	594785
28120-0R021	595710
28130-0R020	595665
28140-0Q010	594479
28150-0Q010	594735
28150-0R020	594784
28160-0Q010	594721
28160-0R020	594786
28160-0R021	595631
<b>VAG (AUDI/SEAT/SKODA/VW)</b>	
021903119G	588001



	
<b>VAG (AUDI/SEAT/SKODA/VW) (.../...)</b>	
021903119H	588050
021903119J	588096
021903119K	588050
021903119L	588096
022903119A	588001
022903119B	588008
022903119C	588001
022903119D	588001
022903119D	588008
022903119D	588014
028903119AA	588014
028903119AB	588008
028903119AC	588008
028903119AM	588001
028903119AN	588051
028903119AP	588014
028903119AP	588066
028903119AQ	588014
028903119P	588014
028903119S	588066
028903119T	588051
028903165	588051
038903119	588014
038903119	588024
038903119A	588001
038903119B	588001
038903119J	588008
038903119L	588059
038903119M	588008
038903119P	588041
038903119Q	588001
038903119Q	588035
038903119S	588001
038903119T	588001
03C903119A	588018
03C903119C	588018
03C903119D	588016
03C903119D	588018
03C903119F	588018
03D903119A	588013
03G903119B	588016
045903119	588016
045903119A	588001
045903119A	588016
04C903119	588018
058903119C	588099
06B903119A	588001
06B903119A	588032

	
<b>VAG (AUDI/SEAT/SKODA/VW) (.../...)</b>	
06B903119A	588071
06B903119B	588032
06B903119D	588032
06E903119E	588084
06E903119P	588084
06F903119A	588001
06H903119	588016
071903119B	588104
078903119G	588107
L038903119S	588001
<b>VAG (AUDI/VW)</b>	
021903119M	595425
022903119C	599327
022903119D	593490
028903803F	593131
02A911287B	594391
02A911287B	594393
02A911365	594390
02B911287A	594392
02E911287C	595676
02M911115P	595623
02M911211	595624
02M911255G	595640
02M911255H	594676
02M911255K	595625
02M911255L	595635
02M911287H	595735
02M911311D	594683
02M911311F	595621
02M911335J	595639
02M911335K	595641
02M911335M	595622
02M911335N	595634
02M911361	595628
02M911361A	595629
02Z911287	594617
02Z911287B	595617
030903119C	592920
030903213A	593152
030903213C	593150
030903351B	593279
036903119M	593868
038903803K	593480
03C903119E	595356
03D903119	593615
03D903119D	593777
03G903213C	595447

	
<b>VAG (AUDI/VW) (.../...)</b>	
03G903506	595437
03G903506B	599111
03G903803C	595457
03I903023	599205
03L903803	599191
03L903803C	599233
045903119A	599248
047911209A	594381
047911287C	594413
057911255A	594501
057911255B	594502
057911255C	594503
058903119A	593719
059903119D	593900
059903119K	595308
059903119L	599143
059903213E	595297
059903506D	599075
059903537D	595436
059903803G	595458
059903803H	599062
059903803J	599065
059903803M	599233
059903803N	599237
059903803P	599238
059903803R	599294
059911335F	594699
068911311Q	594112
06A903119	599189
06B903119	593592
06B903119A	593494
06B903119B	593778
06B903506F	593482
06B903803B	599316
06C903119	595231
06E903119N	595341
06E903119P	593920
06E903119Q	595333
06E903119S	599137
06E903213	595398
06E903506	595459
06E903506A	593924
06E903506C	595439
06E903537	593922
06E903537A	593925
06E903537B	599110
06E903803M	595339
06E903803N	599103

	
<b>VAG (AUDI/VW) (.../...)</b>	
06E903803T	599234
06F903213B	593285
06F903213C	593798
06F903506	593852
06F903506A	593824
06F903506B	593883
06F903506C	593814
06F903506D	593899
06F903537	593854
06F903537A	593827
06F903537B	593815
06F903537C	593968
06H903119C	599227
06H903803A	599199
06H903803C	599236
071903119A	593723
077903119C	593594
077911287A	594624
078903119H	593593
078903119J	593767
079903119G	595326
079903803B	595327
079903803F	599235
0AM911287	595611
0AM911287A	595726
2H0911287	595598
2H0911287A	595718
30903181	590761
30903193	592943
47903803	593362
57911255	594500
58903119	593711
8V0903119	599252
<b>VAUXHALL</b>	
93175986	588095
93178273	588006
<b>VD USA</b>	
592933	592933
<b>VOLVO</b>	
30659440	599182
30667067	588011
30667610	588080
30667682	588064
30667682	595360
30667687	588003
30667878	588022

	
<b>VOLVO (.../...)</b>	
30737517	588022
30782701	588047
31251071	588010
31251073	588038
31251074	588010
31251074	588029
31251074	588038
31285419	595392
31285815	595395
31285816	595441
31285818	593832
31288893	599078
32872103	95390
32878423	92968
33422395	592729
33422957	593910
33431198	181736
33435819	590568
33439142	592673
3345812	588010
8641982	588010
8658644	588022
8666126	588029
8666126	588038
8666579	588011
8676497	588022
9404328	588077
9442403	593141
9459747	588022
9472909	588047
<b>VOLVO NEDCAR</b>	
32872103	95390
3287215	104809
32872150	97804
32873127	102380
32873143	99931
32878423	92968
33422395	592729
33422957	593910
33423104	182459
33423112	182058
33429051	590542
33429747	594066
33431198	181736
33431263	180593
33435793	101126
33435801	590564

	
<b>VOLVO NEDCAR (.../...)</b>	
33435819	590568
33439118	592724
33439142	592673
33441262	592757
33449430	593180
33453770	592880
33454331	594185
33454349	594275
33454364	105760
33454372	592863
8406217	590553
<b>VOLVO PENTA</b>	
1698689	592754
3090711	592703
840629	105299
840632	92967
841811	102659
847704	592727
847707	101126
847708	102130
847710	2102132
847712	100995
859421	100958
859618	594054
859619	182048
859620	182050
859621	182175
859622	594059
859623	594043
860282	590553
860333	594040
860774	594106
860777	594084
864346	101518
864351	592857
872242	99845
872368	590536
872720	593135
873177	594127
873237	592729
873241	104809
873817	593309
<b>VOLVO TRUCK</b>	
1089451	182169
1696942	2590033
1698689	592754
1698690	592720







# 4.2

---

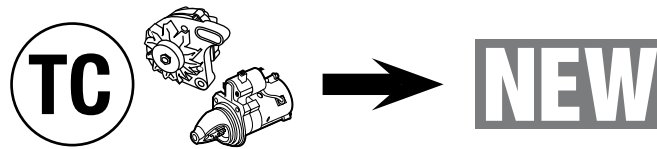
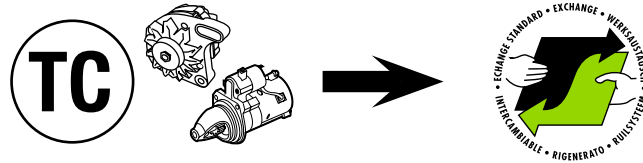

<b>TC</b> Valeo	Valeo
A11VI10	436257
A11VI11	436258
A11VI15	436344
A11VI16	436336
A11VI17	436338
A11VI18	436259
A11VI21	436363
A11VI22	436364
A11VI23	436345
A11VI24	436336
A11VI25	436338
A11VI26	436465
A11VI28	436277
A11VI29	436447
A11VI30	436468
A11VI31	436276
A11VI32	433468
A11VI33	436345
A11VI35	436445
A11VI36	436442
A11VI37	436257
A11VI40	436338
A11VI42	436257
A11VI43	436258
A11VI44	436490
A11VI45	436489
A11VI46	436481
A11VI47	436336
A11VI48	436259
A11VI49	436345
A11VI51	436338
A11VI52	433468
A11VI53	436345
A11VI54	436447
A11VI55	436258
A11VI56	436490
A11VI57	436345
A11VI58	436345
A11VI59	436648
A11VI61	436614
A11VI62	436482
A11VI64	436442
A11VI66	436363
A11VI67	436701
A11VI76	436697

<b>TC</b> Valeo	Valeo
A11VI77	436698
A11VI79	436713
A11VI81	436706
A11VI82	437315
A11VI85	436740
A11VI87	436712
A11VI88	437112
A11VI89	436741
A11VI91	437137
A11VI92	436713
A11VI93	436740
A11VI94	436750
A11VI95	437170
A11VI96	436714
A11VI97	437140
A11VI98	437119
A11VI99	437192
A11VI101	437191
A11VI102	437190
A11VI104	437203
A11VI105	437206
A11VI106	437355
A11VI108	437345
A11VI110	437323
A11VI111	437313
A13N6	433416
A13N10	436320
A13N11	436355
A13N12	433417
A13N13	436313
A13N14	433438
A13N15	433430
A13N17	433435
A13N18	433414
A13N19	433411
A13N20	433429
A13N27	433441
A13N29	433420
A13N30	433444
A13N31	433414
A13N33M	436421
A13N38	433358
A13N42	433374
A13N43	433358
A13N46	433404

<b>TC</b> Valeo	Valeo
A13N53	433426
A13N56M	436352
A13N62	436356
A13N64	436308
A13N65	433437
A13N69	433472
A13N76	433474
A13N80	436102
A13N81	433447
A13N83	433384
A13N84	433392
A13N85	433418
A13N86	433445
A13N87	433448
A13N88	433447
A13N89	433444
A13N91	433411
A13N92	436312
A13N93	436499
A13N95	433364
A13N103	433429
A13N104	433442
A13N107	436602
A13N109	436312
A13N110	433442
A13N113	433429
A13N114	433440
A13N117	436602
A13N118	433380
A13N119	436350
A13N120	433449
A13N121	433442
A13N123	433454
A13N124	436455
A13N126	433449
A13N127	433488
A13N128+	433489
A13N129	433455
A13N130+	436314
A13N133+	436309
A13N136	433465
A13N137	433441
A13N138+	436472
A13N139	433465
A13N140T	436352

<b>TC</b> Valeo	Valeo
A13N144T	433380
A13N150	433440
A13N151+	433457
A13N156+	436681
A13N157	433459
A13N158+	436250
A13N159+	433463
A13N160	433441
A13N161+	436255
A13N162+	433461
A13N163	433460
A13N164+	433460
A13N166M	436427
A13N167	433487
A13N169	436473
A13N171+	433462
A13N172+	436455
A13N173+	433467
A13N175	433455
A13N176+	436314
A13N177+	433457
A13N178+	436309
A13N179+	436472
A13N181	433364
A13N182	433487
A13N183+	433457
A13N184+	433468
A13N185+	436602
A13N187	433447
A13N199+	436254
A13N200+	436252
A13N201+	436253
A13N203	433459
A13N204+	436461
A13N206+	436255
A13N207+	436371
A13N209	436255
A13N210	433441
A13N214	436161
A13N215	433455
A13N216+	436314
A13N217+	433468
A13N218	433364
A13N219	433487
A13N220+	433457

<b>TC Valeo</b>	<b>Valeo</b>
A13N221	433374
A13N226	433448
A13N229T	436347
A13N230+	436254
A13N231	436473
A13N233+	436472
A13N234	436676
A13N235+	436372
A13N236M	436427
A13N237	436373
A13N238+	436374
A13N239+	436316
A13N240	433364
A13N241+	436309
A13N242+	436472
A13N245+	437182
A13N247+	436248
A13N255	436376
A13N257	436377
A13N259	436378
A13N269	436446
A13N274+	436715
A13N275+	436716
A13N276+	436717
A13N277	436708
A13N278+	436709
A13N279+	436710
A13N280+	436711
A13N281	436496
A13N283M	436664
A13N289	436645
A13N303	437505
A13V07	436785
A13VI10	436379
A13VI14	436276
A13VI16	436277
A13VI17	436278
A13VI18	436380
A13VI20	436279
A13VI21	436280
A13VI23	436281
A13VI24	436381
A13VI25	436282
A13VI28	436382
A13VI30	436463

<b>TC Valeo</b>	<b>Valeo</b>
A13VI31	436340
A13VI32	436283
A13VI34	436284
A13VI35	436285
A13VI40	436443
A13VI41	436444
A13VI44	436445
A13VI45	436403
A13VI46	436260
A13VI47	436383
A13VI48	436346
A13VI49	436339
A13VI51	436346
A13VI52	436384
A13VI54	436385
A13VI55	436469
A13VI57	436467
A13VI59	436486
A13VI60	436488
A13VI61	436682
A13VI62	436471
A13VI63	436449
A13VI64	436618
A13VI65	436661
A13VI66	436470
A13VI67	436386
A13VI68	436474
A13VI69	436387
A13VI70	436388
A13VI71	436366
A13VI72	436635
A13VI73	436636
A13VI74	436450
A13VI75	436451
A13VI76	436619
A13VI77	436389
A13VI78	436675
A13VI80	436475
A13VI81	436476
A13VI82	436487
A13VI83	436260
A13VI84	436611
A13VI85	436340
A13VI86	436346
A13VI87	436339

<b>TC Valeo</b>	<b>Valeo</b>
A13VI88	436346
A13VI94	436613
A13VI95	436668
A13VI96	436260
A13VI97	436607
A13VI99	437126
A13VI100	437125
A13VI101	436654
A13VI102	436642
A13VI104	436615
A13VI105	437205
A13VI106	436616
A13VI107	436617
A13VI108	436474
A13VI109	436475
A13VI114	436483
A13VI116	436678
A13VI118	436653
A13VI119	436655
A13VI121	436484
A13VI122	437329
A13VI123	436443
A13VI124	436444
A13VI125	436445
A13VI126	436449
A13VI130	436665
A13VI131	436637
A13VI132	436641
A13VI134	437126
A13VI135	437125
A13VI137	436644
A13VI138	436640
A13VI139	436646
A13VI140	436488
A13VI141	436666
A13VI142	436669
A13VI148	436647
A13VI149	436656
A13VI150	436665
A13VI151+	436731
A13VI152	436702
A13VI153	436662
A13VI155	436387
A13VI156	436640
A13VI157	436275

<b>TC Valeo</b>	<b>Valeo</b>
A13VI160	436746
A13VI163	436469
A13VI164	436728
A13VI165	436739
A13VI166	436730
A13VI167	436729
A13VI170	436667
A13VI173	436744
A13VI175	436718
A13VI176	436667
A13VI178	436732
A13VI179	436743
A13VI180	436700
A13VI181	437316
A13VI184	436737
A13VI185	436745
A13VI188	436742
A13VI189	436476
A13VI190	437117
A13VI191	436366
A13VI192+	436751
A13VI193+	436752
A13VI195	436748
A13VI197	437126
A13VI198	437125
A13VI200	437118
A13VI201	436749
A13VI202	437346
A13VI203	437138
A13VI204	437139
A13VI207	436735
A13VI208	436736
A13VI209	436728
A13VI210	436729
A13VI211	436730
A13VI212	436737
A13VI213	436745
A13VI216	436733
A13VI217	436739
A13VI218	437142
A13VI220	436667
A13VI222	436718
A13VI223	437404
A13VI224	436738
A13VI227	437141

<b>TC Valeo</b>	<b>Valeo</b>
A13VI231	436613
A13VI233	436654
A13VI234	437227
A13VI235	437168
A13VI236	437194
A13VI237	436732
A13VI238	437353
A13VI241	437172
A13VI242	437193
A13VI243	437195
A13VI244	437209
A13VI246	437186
A13VI251	437196
A13VI252	437197
A13VI253	437200
A13VI254	437198
A13VI255	437199
A13VI256	437185
A13VI257	437114
A13VI258	437187
A13VI259	437306
A13VI260	436668
A13VI261	436613
A13VI262	436642
A13VI263	436654
A13VI264	437201
A13VI265	437202
A13VI266	437204
A13VI267	437205
A13VI268	437142
A13VI269	437141
A13VI274	437187
A13VI276	437356
A13VI277	437357
A13VI278	437344
A13VI279	437343
A13VI280	436476
A13VI281	436366
A13VI283	437409
A13VI284	437326
A13VI285	437347
A13VI286	437362
A13VI287	437363
A13VI288	437344
A13VI289	437322

<b>TC Valeo</b>	<b>Valeo</b>
A13VI290	437368
A13VI291	437353
A13VI292	436735
A13VI293	437369
A13VI297	437408
A13VI300	436748
A13VI302	437489
A13VI303	437499
A13VI304	437511
A13VI305	437522
A13VI306	437513
A13VI308	437552
A13VI310	440011
A14N1	433368
A14N2	433368
A14N4	436360
A14N9	436320
A14N12	436247
A14N18	436322
A14N19	436248
A14N22	433371
A14N23	436246
A14N28T	436348
A14N35	436320
A14N39	436412
A14N42	433368
A14N43M	436348
A14N44M	436348
A14N51	436326
A14N54	436249
A14N55	433368
A14N59	436320
A14N60	433452
A14N62	433451
A14N64	433450
A14N67+	436599
A14N71	436595
A14N73	436452
A14N74	436390
A14N75+	433466
A14N76+	433458
A14N81M	436437
A14N83	436320
A14N88	436320
A14N91	436435

<b>TC Valeo</b>	<b>Valeo</b>
A14N96	433452
A14N97	436307
A14N102	436594
A14N104+	436434
A14N110M	436351
A14N114T	436351
A14N115M	436351
A14N116M	436351
A14N118M	436734
A14N119M	436438
A14N121	436456
A14N123	436343
A14N124+	436457
A14N125	433452
A14N131	433464
A14N132	436454
A14N133	436412
A14N134	433450
A14N135	436433
A14N138+	436434
A14N139	433469
A14N140+	433466
A14N141M	436438
A14N142	433466
A14N144	433453
A14N145	436343
A14N150	436453
A14N151	433464
A14N152	436335
A14N156	436251
A14N158	436464
A14N160+	436680
A14N163	436349
A14N164	436256
A14N171	436462
A14N172	433469
A14N173	436343
A14N176	436391
A14N177M	436707
A14N178	436383
A14N180+	436274
A14N181	436343
A14N182	436650
A14N183M	436393
A14N185	436394

<b>TC Valeo</b>	<b>Valeo</b>
A14N190	436395
A14N195	436343
A14N196M	436663
A14N198M	436707
A14N199	436651
A14N200M	436639
A14N205+	436652
A14N206M	436703
A14N208M	437352
A14S054	437160
A14S055	437406
A14V01	436134
A14V02	436300
A14V03	436132
A14V04	436398
A14V05	436134
A14VI10	436477
A14VI11	436612
A14VI13	436478
A14VI14	436643
A14VI15+	436670
A14VI16+	436671
A14VI17+	436679
A14VI18	436677
A14VI22	437115
A14VI23	436753
A14VI24	436677
A14VI25	436679
A14VI27+	437171
A14VI28	437116
A14VI29+	437160
A14VI30	436477
A14VI31	437164
A14VI34	437309
A14VI35	437210
A14VI36	437365
A14VI37	437307
A14VI41	437210
A14VI42	437171
A14VI45	437410
A14VI46	437309
A14VI47	437417
A14VI48	437458
A14VI49	437407
A14VI52	437406

<b>TC</b> Valeo	<b>Valeo</b>
A14VI53	437421
D6G1	458191
D6G2	458225
D6G3	436062
D6G5	455949
D6G32	458191
D6G33	458375
D6G321	458191
D6G332	458430
D6GS11	458213
D6GS11M	458213
D6GS12	458214
D6GS12M	458214
D6GS13	458215
D6GS13M	458215
D6GS14	458216
D6GS14M	458216
D6GS19	458238
D6RA5	433311
D6RA6	433320
D6RA8	436064
D6RA10	433311
D6RA12	433321
D6RA13	436053
D6RA16	436064
D6RA18	436064
D6RA20	433311
D6RA25	436001
D6RA26	433342
D6RA28	436000
D6RA30	433333
D6RA32	458228
D6RA33	436060
D6RA37	436062
D6RA38	436065
D6RA39	455511
D6RA41	436079
D6RA42	433243
D6RA43	433200
D6RA44	433206
D6RA45	455551
D6RA46	436081
D6RA47	433301
D6RA48	433297
D6RA51	436090

<b>TC</b> Valeo	<b>Valeo</b>
D6RA53	455551
D6RA56	436081
D6RA57	436062
D6RA59	455553
D6RA61	433320
D6RA62	458228
D6RA63	455693
D6RA66	455512
D6RA67	455737
D6RA68	436003
D6RA70	455956
D6RA72	433321
D6RA73	455738
D6RA74	455961
D6RA76	455697
D6RA78	455739
D6RA79	455968
D6RA80	455931
D6RA81	455932
D6RA82	455736
D6RA83	455949
D6RA87	455958
D6RA91	455980
D6RA93	458228
D6RA100	455955
D6RA101	455936
D6RA104	455936
D6RA105	455976
D6RA107	455956
D6RA108	455970
D6RA109	455960
D6RA110	455982
D6RA114	458277
D6RA115	455976
D6RA133	436060
D6RA137	455975
D6RA138	458163
D6RA141	436079
D6RA162	458228
D6RA163	458228
D6RA167	455951
D6RA168	436003
D6RA169	433297
D6RA180	455952
D6RA181	455953

<b>TC</b> Valeo	<b>Valeo</b>
D6RA187	455975
D6RA188	458163
D6RA190	455937
D6RA249	458228
D6RA293	458228
D6RA421	433243
D6RA431	433200
D6RA441	433206
D6RA511	436090
D6RA571	436062
D6RA572	436062
D6RA661	455512
D6RA721	433321
D6RA811	455715
D6RAD183	458164
D7E1	455722
D7E4	455747
D7E5	455748
D7E6	455876
D7E8	455747
D7E15	455950
D7E16	455962
D7E18	455747
D7E19	455974
D7E20	455950
D7E22	455876
D7E26	455983
D7E27	458179
D7E29	455984
D7E30	455985
D7E31	458159
D7E32	458170
D7E38	455747
D7E39	455722
D7E40	455985
D7E41	458159
D7E42	458170
D7E47	458179
D7E52	458162
D7E62	433278
D7E70	433276
D7E79	433325
D7ED28	458165
D7ED281	458165
D7G3	458185

<b>TC</b> Valeo	<b>Valeo</b>
D7G4	458166
D7G6	458181
D7G11	458210
D7G13	458236
D7G14	458240
D7G15	458275
D7G18	458256
D7G26	458237
D7GS7	458182
D7GS8	458217
D7GS9	458231
D7GS10	458218
D7GS17	458186
D7R1	433323
D7R2	455514
D7R3	433323
D7R4	455514
D7R5	436051
D7R7	455873
D7R8	455514
D7R9	455513
D7R11	433323
D7R12	455691
D7R13	455550
D7R14	455735
D7R15	455687
D7R16	455698
D7R17	455734
D7R18	455719
D7R19	455720
D7R20	455749
D7R22	455741
D7R23	455745
D7R25	455695
D7R26	455928
D7R27	455929
D7R28	455720
D7R40	455957
D7R41	436044
D7R42	455873
D7R43	455720
D7R44	455959
D7R46	455720
D7R47	455971
D7R48	455972

<b>TC</b> Valeo	Valeo
D7R49	455971
D7R53	458172
D7R53d	458172
D7R56	455954
D7R57	455899
D7R61	458192
D7R64	458118
D7R65	455674
D7R70	455895
D7R151	455687
D7RS29	455727
D7RS30	455927
D7RS31	458041
D7RS50	458167
D7RS129	455930
D7RS130	455927
D7RS131	458041
D7RS150	458167
D7RS291	455548
D7RS301	455672
D7R33	455933
D7R34	455954
D7R35	455943
D7R36	455948
D7R37	458171
D8R1	458178
D8R27	458180
D8R28	458289
D8R29	458249
D8R39	433318
D8R49	458290
D9E20	433247
D9E31	433237
D9E32	433237
D9E36	433223
D9E38	433231
D9E39	433249
D9E43	433304
D9E44	433304
D9E54	433223
D9E55	433247
D9E57	433226
D9E61	433223
D9E62	433223
D9E64	433204

<b>TC</b> Valeo	Valeo
D9E70	433209
D9E76	433249
D9E78	433245
D9E82	433237
D9E83	433304
D9E85	433307
D9E86	433209
D9E104	436057
D9E111	433266
D9E131	433304
D9E132	433304
D9E136	436016
D9E137	436059
D9E138	436058
D9E140	433266
D9E238	436058
D9E701	433209
D9E771	433309
D9E772	433249
D9E773	433249
D9E774	433309
D9E776	433309
D9E851	433307
D9E852	433307
D9E861	433209
D9R73	433310
D9R84	433305
D9R89	433229
D9R90	433215
D9R91	436052
D9R97	433327
D9R99	436063
D9R105	433329
D9R106	433219
D9R112	433332
D9R116	455537
D9R118	433306
D9R119	436002
D9R121	433324
D9R122	436068
D9R134	436061
D9R135	433339
D9R139	436041
D9R142	455552
D9R144	455537

<b>TC</b> Valeo	Valeo
D9R149	455554
D9R1050	433329
D13HP601	455733
D13HP605	455688
D13HP607	455702
D13HP608	455750
D13HP609	455742
D13HP613	455723
D13HP701	455703
D13HP702	455704
D13HP703	455509
D13HP704	455703
D13HP705	455510
D13HP709	455723
FG9T011	440355
FG9T012	440418
FG15T030	440358
FG15T036	440264
FG15T044	440351
FG15T045	440573
FG15T050	440457
FG15T056	440462
FG15T057	440559
FG15T072	440351
FG15T079	440474
FG17T010	440580
FG18D024	440237
FG18D037	440312
FG18D057	440299
FG18D111	440456
FG18S011	440255
FG18S012	440238
FG18S013	440175
FG18S014	440252
FG18S016	440219
FG18S017	440177
FG18S019	440183
FG18S022	440197
FG18S023	440198
FG18S027	440275
FG18S029	440331
FG18S032	440329
FG18S036	440205
FG18S039	440305
FG18S040	440267

<b>TC</b> Valeo	Valeo
FG18S043	440266
FG18S044	440466
FG18S045	440430
FG18S046	440307
FG18S047	440295
FG18S048	440288
FG18S052	440300
FG18S056	440334
FG18S060	440322
FG18S061	440354
FG18S066	440465
FG18S073	440303
FG18S077	440328
FG18S078	440360
FG18S083	440335
FG18S093	440437
FG18S095	440275
FG18S097	440604
FG18S098	440405
FG18S099	440406
FG18S100	440410
FG18S108	440197
FG18S109	440198
FG18S110	440502
FG18S127	440473
FG18S128	440472
FG18S130	440561
FG18S133	440648
FG18S134	440660
FG18S135	440627
FG18S138	440607
FG18S141	440614
FG18T033	440253
FG18T041	440271
FG18T042	440272
FG18T051	440308
FG18T062	440341
FG18T063	440301
FG18T070	440325
FG18T071	440304
FG18T072	440340
FG18T074	440326
FG18T079	440415
FG18T084	440327
FG18T094	440416



<b>TC</b> Valeo	Valeo
FG18T101	440560
FG18T106	440649
FG18T112	440275
FG18T115	440341
FG18T117	440326
FG18T118	440253
FG18T119	440562
FG18T120	440563
FG18T121	440564
FG18T122	440565
FG18T123	440415
FG20S011	440413
FG20S014	440362
FG20S015	440438
FG20S016	440439
FG20S017	440435
FG20S018	440440
FG20S019	440605
FG20S022	440630
FG23S010	440203
FG23S011	440256
FG23S012	440357
FG23S013	440273
FG23S021	440274
FG23S022	440426
FG23S025	440269
FG23S026	440270
FG23S027	440333
FG23S028	440302
FG23S031	440306
FG23S032	440320
FG23S033	440419
FG23S035	440346
FG23S039	440332
FG23S040	440464
FG23S041	440434
FG23S043	440203
FG23S046	440339
FG23S048	440361
FG23S049	440330
FG23S054	440203
FG23S057	440426
FG23S058	440321
FG23S059	440555
FG23S061	440346

<b>TC</b> Valeo	Valeo
FG23S062	440467
FG23S063	440426
FG23S065	440470
FG23S066	440471
FG23S068	440558
FG23S073	440596
FG23S074	440597
FG23S075	440598
FS10E10	458392
SG7S010	437393
SG7S012	437428
SG7S013	437393
SG7S014	437137
SG7S015	437355
SG7S016	437460
SG7S020	437413
SG7S021	437414
SG7S024	437137
SG7S026	437207
SG7S028	437313
SG7S070	437428
SG7S071	437393
SG7S074	437313
SG8B010	437177
SG8B011	437315
SG8B013	437395
SG8B015	437396
SG8B016	437397
SG8B017	437398
SG8B018	437399
SG8B020	437138
SG8B021	437356
SG8B022	437461
SG8B023	437412
SG8B026	437445
SG8B027	437395
SG8B029	437396
SG9B010	437348
SG9B011	437174
SG9B013	437316
SG9B015	437400
SG9B017	437340
SG9B018	437401
SG9B019	437402
SG9B023	437403

<b>TC</b> Valeo	Valeo
SG9B024	437404
SG9B025	437221
SG9B027	437175
SG9B029	437366
SG9B033	437311
SG9B035	437373
SG9B037	436732
SG9B038	437114
SG9B039	437346
SG9B040	437374
SG9B042	437340
SG9B048	437411
SG9B049	437316
SG9B050	437374
SG9B052	437463
SG9B053	437424
SG9B054	437431
SG9B055	437419
SG9B057	437444
SG9B059	437316
SG9B063	437356
SG9B064	437461
SG9B066	437356
SG9B067	437461
SG9B069	437403
SG9B077	436476
SG9B078	437400
SG9B079	437537
SG9B087	437316
SG9B088	437316
SG9B089	437424
SG9B095	437401
SG9B107	437373
SG9B108	437424
SG9B121	437537
SG10B010	437322
SG10B011	437183
SG10B013	437314
SG10B014	437314
SG10B016	437321
SG10B019	437322
SG10B021	437139
SG10B022	437357
SG10B023	437409
SG10B031	437183

<b>TC</b> Valeo	Valeo
SG10B032	437443
SG10B035	437183
SG10B048	437550
SG11B010	437449
SG12B010	437188
SG12B011	437178
SG12B012	437341
SG12B015	437317
SG12B016	437189
SG12B017	437208
SG12B018	437176
SG12B021	437222
SG12B022	437223
SG12B023	437224
SG12B024	437312
SG12B025	437173
SG12B027	437225
SG12B028	437226
SG12B029	437367
SG12B030	437423
SG12B038 SP	440236
SG12B039	437320
SG12B040	437349
SG12B042	437339
SG12B044	437375
SG12B045	437325
SG12B047	437364
SG12B049	437341
SG12B050	437351
SG12B052	437437
SG12B054	437358
SG12B055	437361
SG12B060	437376
SG12B062	437430
SG12B063	437425
SG12B065	437375
SG12B068	437423
SG12B071	437208
SG12B072	437423
SG12B074	437420
SG12B075	437364
SG12B080	437227
SG12B081	437437
SG12B082	437425
SG12B087	437540

<b>TC</b> Valeo	Valeo
SG12B089	437559
SG12B090	437317
SG12B092	440059
SG12B095	437351
SG12B096	437208
SG12B097	437423
SG12B098	437437
SG12B103	440028
SG12B105	440056
SG12B107	437423
SG12B108	437351
SG12B109	437437
SG12B110	437208
SG12B116	437351
SG12B122	437423
SG12B123	437208
SG12B124	440059
SG12B127	437392
SG12S019	436749
SG12S073	437426
SG14B010	437360
SG14B011	437377
SG14B012	437359
SG14B013	437418
SG14B016	437360
SG14B017	437435
SG14B019	437500
SG14B020	437500
SG14B022	437360
SG15L012	437415
SG15L020	437433
SG15L023	440012
SG15L026	437415
SG15L027	437433
SG15L033	440012
SG15L034	437433
SG15L035	437433
SG15L036	440012
SG15S010	437350
SG15S016	437171
SG15S017	437436
SG15S018	437210
SG15S019	437432
SG15S021	437171
SG15S022	437210

<b>TC</b> Valeo	Valeo
SG15S024	437458
SG15S025	437407
SG15S030	437421
SG15S031	437457
SG15S032	437350
SG15S037	437432
TG7S010	437355
TG7S011	437460
TG7S012	440063
TG7S013	437460
TG7S014	440284
TG7S017	440063
TG8C011	437455
TG8C018	437543
TG8S010	437475
TG8S012	437473
TG8S013	437503
TG8S014	437503
TG8S016	437503
TG8S017	437112
TG8S019	437543
TG8S021	437475
TG8S022	437473
TG8S023	437503
TG8S024	440074
TG8S025	437112
TG9B024	437356
TG9B025	437461
TG9B026	437584
TG9B028	440017
TG9B042	440185
TG9B043	437461
TG9B044	437584
TG9B045	440017
TG9B047	440246
TG9B049	440202
TG9B052	440261
TG9B053	440246
TG9B064	440277
TG9B065	440289
TG9B066	440279
TG9B067	440280
TG9B068	440291
TG9B107	440557
TG9C013	437453

<b>TC</b> Valeo	Valeo
TG9C095	437453
TG9S010	437474
TG9S011	437533
TG9S015	437504
TG9S016	437504
TG9S021	437504
TG9S022	437504
TG9S027	440151
TG9S036	437474
TG9S037	440239
TG9S038	437504
TG9S039	437533
TG9S040	440151
TG9S060	440297
TG9S063	437504
TG9S100	440417
TG10B013	437550
TG10B024	437550
TG10B025	440245
TG11C010	437439
TG11C011 SP	437434
TG11C014	437502
TG11C015	437456
TG11C016	437469
TG11C017	437470
TG11C022	437439
TG11C024	437488
TG11C027	440036
TG11C034	437558
TG11C035	437544
TG11C036	437532
TG11C040	440060
TG11C041	440068
TG11C048	440038
TG11C049	437439
TG11C054	440066
TG11C055	440065
TG11C056	440092
TG11C057	440204
TG11C059	437532
TG11C060	440065
TG11C061	437439
TG11C063	440036
TG11C064	437558
TG11C065	440060

<b>TC</b> Valeo	Valeo
TG11C066	440068
TG11C067	440342
TG11C068	440092
TG11C069	440068
TG11C073	440251
TG11C074	437544
TG11C086	440323
TG11C094	440345
TG11C095	440344
TG11C096	440309
TG11C131	440599
TG12C013	437448
TG12C015	437524
TG12C016	437585
TG12C026	440128
TG12C037	440135
TG12C038	440199
TG12C039	440181
TG12C059	440174
TG12C062	440218
TG12C063	440263
TG12C077	440247
TG12C078	440262
TG12C079	440575
TG12C087	440135
TG12C090	440268
TG12C091	440461
TG12C092	440427
TG12C094	440265
TG12C106	440350
TG12C107	440574
TG12C109	437448
TG12C110	437524
TG12C113	440609
TG12C118	440352
TG12C120	440174
TG12C124	440503
TG12C125	440469
TG12C139	440610
TG12C140	440268
TG12C141	440352
TG12C150	440262
TG12C151	440265
TG12C198	440461
TG12C199	440427

<b>TC Valeo</b>	<b>Valeo</b>
TG12S101	440298
TG12S111	440412
TG12S128	440436
TG14C011	437454
TG14C012	437562
TG14C014	437553
TG14C015	437526
TG14C016	437454
TG14C018	440243
TG14C019	440429
TG14C020	440208
TG14C022	440209
TG14C023	440240
TG14C025	440483
TG14C026	440249
TG14C027	440250
TG14C028	440310
TG14C031	440314
TG14C034	440343
TG14C035	440311
TG14C036	440324
TG14C037	440315
TG14C039	440359
TG14C040	440460
TG14C041	440468
TG14C042	440209
TG14C043	440428
TG14C044	440356
TG14C046	440639
TG14C047	440409
TG14C049	440475
TG14C054	440590
TG14C055	440591
TG14C056	440556
TG14C057	440592
TG14C058	440593
TG14C059	440594
TG14C060	440595
TG14C067	440600
TG14C068	440602
TG14C071	440640
TG15C012	437452
TG15C015	437429
TG15C017	437468
TG15C018	437451

<b>TC Valeo</b>	<b>Valeo</b>
TG15C018b	437451
TG15C020	437471
TG15C022	437472
TG15C023	437457
TG15C027	437538
TG15C027b	437538
TG15C028	437471
TG15C038	437417
TG15C043	440025
TG15C053	437471
TG15C054	437472
TG15C057b	437545
TG15C057c	437545
TG15C058	440034
TG15C060	440241
TG15C064	437583
TG15C065	437468
TG15C072	440179
TG15C073	440106
TG15C075	440127
TG15C091	440035
TG15C093	437538
TG15C094	440244
TG15C095	440211
TG15C098	440064
TG15C103	440200
TG15C112	440180
TG15C117	437429
TG15C118	437471
TG15C119	437472
TG15C120	440201
TG15C121	437545
TG15C123	440187
TG15C124	440188
TG15C125	440035
TG15C127	440186
TG15C128	440217
TG15C130	440257
TG15C131	440258
TG15C133	440264
TG15C134	440260
TG15C135	440286
TG15C137	440248
TG15C141	440188
TG15C142	440664

<b>TC Valeo</b>	<b>Valeo</b>
TG15C143	440215
TG15C144	440242
TG15C145	437527
TG15C146	440216
TG15C148	440586
TG15C149	440338
TG15C152	440585
TG15C154	440282
TG15C156	440281
TG15C157	440313
TG15C165	440285
TG15C169	440576
TG15C177	440414
TG15C181	440347
TG15C182	440336
TG15C189	440286
TG15C190	440408
TG15C194	440458
TG15C195	440662
TG15C196	440414
TG15C200	440633
TG15S205	440286
TG16C010	437527
TG16C011	437563
TG16C012	437541
TG16C013	437554
TG16C014	440039
TG17C010	437450
TG17C010b	437450
TG17C011	437556
TG17C016	437564
TG17C016b	437564
TG17C019	437555
TG17C020	437507
TG17C021	437498
TG17C021b	437498
TG17C022	437535
TG17C023	437528
TG17C024	437542
TG17C026	440037
TG17C027	437529
TG17C027b	437529
TG17C030	437539
TG17C030b	437539
TG17C032	440053

<b>TC Valeo</b>	<b>Valeo</b>
TG17C034	440108
TG17C035	437579
TG17C036	440097
TG17C039	440184
TG17C040	440042
TG17C041	440057
TG17C044	437528
TG17C048	440107
TG17C054	437542
TG17C061	440176
TG17C065	440042
TG17C072	437507
TG23C011	440095
TG23C012	440109
TG23C013	440096
TG23C017	440178
TG23C018	440206
TG23C019	440124
TG23C022	440182
TG23C033	440206
TG23C034	440441
TG23C035	440463
TS10E1	458248
TS10E3	458179
TS10E4	455974
TS10E5	455876
TS10E5(b)	455876
TS8E2	455962
TS8E3	455985
TS8E4	458159
TS8E5	458170
TS8E6	455722
TS8E6(B)	455722
TS12-77	458721
TS12E30	458225
TS12E36	458403
TS12E901	458703
TS12E902	458704
TS12ER15	458431
TS12ER15M	458431
TS12ER19	458428
TS12ER20	458372
TS12ER22	458422
TS12ER22M	458422
TS12ER25	458404

<b>TC</b> Valeo	Valeo
TS14E110	455982
TS14E16	458427
TS14E17	458425
TS14E6	458426
TS14E7	458424
TS18E1(b)	458217
TS18E13	458185
TS18E3(b)	458218
TS18E33	458351
TS18E331	458351
TS18E7	458364
TS18ER121(b)	458389
TS18ER123	458390
TS18ER123(b)	458390
TS18ER20(B)	458391
TS18ER21	458714
TS18ER22	458412
TS18ER23	458648
TS22-31	458367
TS22-32	458423
TS22-33	458676
TS22E20	458446
TS22E26	458237
TS22E45	458397
TS22E5	458291
TS22ER12	458411
TS22ER13	458411
TS24E13	458395
TS24E2(A)	458387
TS24E3	458373
TS24E30	458373
TS24E6	458416
TS24E7	458415

<b>TC</b> Valeo	Valeo
-----------------	-------

<b>TC</b> Valeo	Valeo
-----------------	-------

<b>TC</b> Valeo	Valeo
-----------------	-------





<b>TC</b>	<b>Valeo NEW</b>
A11VI10	433153
A11VI11	433154
A11VI15	433187
A11VI16	433185
A11VI18	433155
A11VI21	439000
A11VI23	433188
A11VI24	433161
A11VI25	433162
A11VI26	439015
A11VI28	433167
A11VI29	439014
A11VI30	439017
A11VI31	433166
A11VI35	439063
A11VI36	439001
A11VI37	433153
A11VI40	433162
A11VI42	433153
A11VI43	433154
A11VI45	439039
A11VI46	439030
A11VI47	433185
A11VI49	433188
A11VI51	433162
A11VI54	439014
A11VI55	433154
A11VI56	439040
A11VI57	433188
A11VI59	439077
A11VI61	439057
A11VI62	439031
A11VI64	439001
A11VI66	439000
A11VI67	439171
A11VI72	541854
A11VI76	439168
A11VI77	439169
A11VI79	439077
A11VI81	439182
A11VI85	439057
A11VI87	439202
A11VI88	439230
A11VI89	439214
A11VI91	439246

<b>TC</b>	<b>Valeo NEW</b>
A11VI92	439204
A11VI93	439213
A11VI94	439226
A11VI95	439256
A11VI96	439205
A11VI97	439249
A11VI98	439238
A11VI99	439275
A11VI101	439274
A11VI102	439273
A11VI104	439287
A11VI105	439291
A11VI106	439275
A11VI108	439332
A11VI110	439320
A11VI111	439308
A13N4T	100363
A13N6	432754
A13N10	432708
A13N11	100442
A13N12	432759
A13N13	432728
A13N14	432729
A13N15	432733
A13N17	432734
A13N18	432735
A13N19	432736
A13N20	432724
A13N27	433061
A13N29	432763
A13N30	432765
A13N31	432738
A13N33M	510397
A13N34	104551
A13N35M	103141
A13N36M	592777
A13N38	432739
A13N42	432746
A13N43	432739
A13N46	432747
A13N49	432749
A13N50	432753
A13N51	101823
A13N52	101822
A13N53	432771

<b>TC</b>	<b>Valeo NEW</b>
A13N55M	105582
A13N56M	100363
A13N57M	103142
A13N58M	102053
A13N59M	102054
A13N60T	102055
A13N61T	102056
A13N62	101728
A13N64	432755
A13N65	432756
A13N66M	102341
A13N80	432772
A13N81	432764
A13N84	433075
A13N85	432759
A13N86	432763
A13N87	432764
A13N88	432764
A13N89	432765
A13N90	432766
A13N91	432736
A13N92	432719
A13N93	432767
A13N94+	432768
A13N95	432769
A13N97	105789
A13N103	432724
A13N104	432726
A13N106	432716
A13N107	432717
A13N108+	432718
A13N109	432719
A13N110	432726
A13N112	180580
A13N113	432724
A13N116	432716
A13N114	432726
A13N117	432717
A13N118	432725
A13N119	183011
A13N120	433042
A13N121	432726
A13N123	433040
A13N124	433066
A13N125+	433109

<b>TC</b>	<b>Valeo NEW</b>
A13N126	433042
A13N127	433087
A13N128+	433088
A13N129	433069
A13N130+	433070
A13N133+	433079
A13N136	433086
A13N137	433065
A13N138+	433080
A13N139	433086
A13N140T	2181757
A13N143M	592777
A13N144T	433380
A13N146T	2518049
A13N147M	518039
A13N148M	518040
A13N149M	590049
A13N150	433081
A13N151+	433082
A13N152M	2518064
A13N156+	433139
A13N157	433096
A13N158+	433097
A13N159+	433098
A13N160	433061
A13N161+	433099
A13N162+	433110
A13N164+	433111
A13N165	592769
A13N166M	592770
A13N167	433094
A13N169	433113
A13N171+	433095
A13N172+	433120
A13N173+	433121
A13N174	592771
A13N175	433069
A13N176+	433070
A13N177+	433082
A13N178+	433079
A13N179+	433080
A13N180+	433109
A13N181	432769
A13N182	433094
A13N183+	433082

<b>TC</b>	<b>Valeo NEW</b>
A13N184+	433122
A13N185+	432718
A13N186M	592772
A13N187	433123
A13N188+	433124
A13N190	592773
A13N199+	433144
A13N200+	433145
A13N201+	433146
A13N203	433147
A13N204+	433148
A13N206+	433149
A13N207+	541314
A13N209	433149
A13N210	433061
A13N214	433055
A13N215	433069
A13N216+	433070
A13N217+	433122
A13N218	432769
A13N219	433094
A13N220+	433082
A13N221	432746
A13N226	439180
A13N230+	433144
A13N231	433113
A13N233+	433080
A13N234	439185
A13N236M	439241
A13N237	439186
A13N238+	439187
A13N239+	432829
A13N240	432769
A13N241+	433079
A13N242+	433080
A13N244	592855
A13N245+	439220
A13N25+	432737
A13N255	592769
A13N257	439101
A13N259	439181
A13N260	439184
A13N261	439188
A13N262	592868
A13N269	439013

<b>TC</b>	<b>Valeo NEW</b>
A13N270	439189
A13N271	439190
A13N272	439191
A13N273+	439192
A13N274+	439097
A13N275+	439098
A13N276+	439099
A13N277	439193
A13N278+	439194
A13N279+	439195
A13N280+	439196
A13N281	101822
A13N282	101823
A13N283M	439043
A13N284+	439041
A13N289	439074
A13N291+	439233
A13N293	439243
A13N296	439288
A13N297	439386
A13N306	439614
A13V07	433138
A13VI13	433176
A13VI14	433166
A13VI16	433167
A13VI17	433168
A13VI18	439038
A13VI20	433169
A13VI21	433170
A13VI22	433164
A13VI23	433171
A13VI24	439123
A13VI25	433172
A13VI30	433158
A13VI31	433159
A13VI32	433173
A13VI34	433174
A13VI35	433175
A13VI40	439002
A13VI41	439003
A13VI44	439004
A13VI45	433177
A13VI46	433156
A13VI47	439167
A13VI48	433157

<b>TC</b>	<b>Valeo NEW</b>
A13VI49	433160
A13VI51	433189
A13VI52	439497
A13VI55	439018
A13VI57	439016
A13VI59	439035
A13VI60	439036
A13VI61	439092
A13VI62	439020
A13VI63	439012
A13VI64	439061
A13VI65	439090
A13VI66	439019
A13VI67	439011
A13VI68	439021
A13VI69	439005
A13VI70	439006
A13VI71	433190
A13VI72	439064
A13VI73	439065
A13VI74	439008
A13VI75	439009
A13VI76	439062
A13VI77	439010
A13VI78	439007
A13VI80	439022
A13VI81	439023
A13VI82	439037
A13VI83	433156
A13VI84	439054
A13VI85	433159
A13VI86	433157
A13VI87	433160
A13VI88	433189
A13VI94	439056
A13VI95	439102
A13VI96	433156
A13VI97	439053
A13VI99	439245
A13VI100	439244
A13VI101	439083
A13VI102	439071
A13VI104	439058
A13VI105	439078
A13VI106	439059

<b>TC</b>	<b>Valeo NEW</b>
A13VI107	439060
A13VI108	439021
A13VI109	439022
A13VI114	439032
A13VI116	439165
A13VI117	439532
A13VI118	439082
A13VI119	439084
A13VI121	439033
A13VI122	439325
A13VI123	439002
A13VI124	439003
A13VI125	439004
A13VI126	439012
A13VI131	439066
A13VI132	439070
A13VI134	439245
A13VI135	439244
A13VI137	439073
A13VI138	439069
A13VI139	439075
A13VI140	439036
A13VI141	439094
A13VI142	439103
A13VI148	439076
A13VI149	439085
A13VI150	439093
A13VI151+	439203
A13VI152	439172
A13VI153	439091
A13VI155	439005
A13VI156	439069
A13VI157	433165
A13VI160	439223
A13VI163	439018
A13VI164	439016
A13VI165	439061
A13VI166	439090
A13VI167	439091
A13VI170	439095
A13VI173	439221
A13VI175	439198
A13VI176	439095
A13VI178	439206
A13VI179	439216



<b>TC</b>	<b>Valeo NEW</b>
A13VI180	439170
A13VI184	439058
A13VI185	439078
A13VI188	439215
A13VI189	439023
A13VI190	439236
A13VI191	433190
A13VI192+	439227
A13VI193+	439228
A13VI194+	439218
A13VI195	439224
A13VI197	439245
A13VI198	439244
A13VI200	439237
A13VI201	439470
A13VI202	439333
A13VI203	439247
A13VI204	439248
A13VI207	439208
A13VI208	439209
A13VI209	439199
A13VI210	439200
A13VI211	439201
A13VI212	439210
A13VI213	439222
A13VI216	439207
A13VI217	439212
A13VI218	439251
A13VI220	439095
A13VI222	439198
A13VI223	439255
A13VI224	439211
A13VI227	439250
A13VI230	439102
A13VI231	439056
A13VI232	439071
A13VI233	439083
A13VI234	439301
A13VI235	439254
A13VI236	439277
A13VI237	439206
A13VI238	439266
A13VI241	439258
A13VI243	439279
A13VI244	439293

<b>TC</b>	<b>Valeo NEW</b>
A13VI246	439269
A13VI249	439267
A13VI251	439280
A13VI252	439281
A13VI253	439284
A13VI254	439282
A13VI255	439283
A13VI256	439268
A13VI257	439232
A13VI258	439270
A13VI259	439302
A13VI260	439102
A13VI261	439056
A13VI262	439071
A13VI263	439083
A13VI264	439285
A13VI265	439286
A13VI266	439289
A13VI267	439290
A13VI268	439251
A13VI269	439250
A13VI273	439103
A13VI274	439270
A13VI276	439277
A13VI277	439276
A13VI278	439329
A13VI279	439330
A13VI280	439023
A13VI281	433190
A13VI283	439449
A13VI284	439322
A13VI285	439334
A13VI286	439236
A13VI287	439237
A13VI288	439331
A13VI289	439389
A13VI290	439399
A13VI291	439388
A13VI292	439208
A13VI293	439400
A13VI297	439448
A13VI300	439302
A13VI303	439530
A13VI304	439528
A13VI305	439531

<b>TC</b>	<b>Valeo NEW</b>
A13VI306	439529
A13VI308	439555
A13VI310	439570
A14N1	432808
A14N3T	100894
A14N4	432783
A14N9	432806
A14N10	101473
A14N11	432776
A14N12	432777
A14N13	432786
A14N14	101795
A14N18	432779
A14N19	432808
A14N22	432811
A14N23	432803
A14N28T	101879
A14N29M	102051
A14N35	432781
A14N36	432782
A14N37	432978
A14N38	432797
A14N39	102334
A14N42	433368
A14N43M	102969
A14N44M	104794
A14N47M	592601
A14N50	432786
A14N51	432785
A14N53	432786
A14N54	433039
A14N55	432808
A14N56	432802
A14N59	432806
A14N60	432814
A14N62	432788
A14N63	432789
A14N64	432793
A14N65	432789
A14N67+	432794
A14N69	432786
A14N70	432796
A14N71	432797
A14N73	432798
A14N75+	432799

<b>TC</b>	<b>Valeo NEW</b>
A14N76+	432801
A14N77	432802
A14N81M	592601
A14N82	433114
A14N83	432809
A14N84	432811
A14N85	432805
A14N86	433072
A14N88	432806
A14N89	432812
A14N91	432808
A14N95+	432813
A14N96	432814
A14N97	432815
A14N99	432812
A14N101	433093
A14N102	433067
A14N104+	541178
A14N105M	105836
A14N106	432786
A14N110M	181695
A14N112M	592601
A14N113	433073
A14N114T	2181760
A14N115M	592786
A14N116M	181762
A14N117	433074
A14N118M	592601
A14N119M	180620
A14N120	433125
A14N121	433126
A14N122M	592601
A14N123	433071
A14N124+	433127
A14N125	432814
A14N130	433107
A14N132	433108
A14N133	592774
A14N134	433089
A14N135	541147
A14N137M	592775
A14N138+	541178
A14N139	433129
A14N140+	433130
A14N141M	592776

<b>TC</b>	<b>Valeo NEW</b>
A14N142	433131
A14N144	432783
A14N145	433071
A14N150	433132
A14N151	433133
A14N152	433184
A14N156	433150
A14N158	433163
A14N160+	592778
A14N163	439240
A14N164	433151
A14N171	433152
A14N172	433129
A14N173	433071
A14N178	433178
A14N181	433186
A14N182	439079
A14N183M	439231
A14N190	439390
A14N195	433186
A14N196M	592786
A14N198M	439183
A14N199	439080
A14N200M	439068
A14N205+	439081
A14N206M	439173
A14N207M	439314
A14N208M	439231
A14R39T	439278
A14R54T	103163
A14R541T	103164
A14R542T	103484
A14S054	439252
A14S055	439446
A14V01	433128
A14V02	433134
A14V03	433136
A14V04	433191
A14V05	433134
A14VI10	439024
A14VI11	439055
A14VI13	439025
A14VI14	439072
A14VI15+	439104
A14VI16+	439105

<b>TC</b>	<b>Valeo NEW</b>
A14VI17+	439166
A14VI18	439164
A14VI21	439217
A14VI22	439234
A14VI23	439229
A14VI24	439164
A14VI25	439166
A14VI27+	439257
A14VI28	439235
A14VI29+	439252
A14VI30	439024
A14VI31	439253
A14VI34	439305
A14VI35	439294
A14VI36	439396
A14VI37	439303
A14VI39	439387
A14VI41	439294
A14VI42	439257
A14VI45	439450
A14VI46	439305
A14VI47	439459
A14VI48	439493
A14VI49	439447
A14VI52	439446
A14VI53	439463
D6G1	438168
D6G2	438177
D6G3	432623
D6G5	438079
D6G32	438168
D6G33	438211
D6G321	438168
D6G332	438270
D6GS11	438171
D6GS11M	438171
D6GS12	438172
D6GS12M	438172
D6GS13	438173
D6GS13M	438173
D6GS14	438174
D6GS14M	438174
D6GS19	438190
D6RA5	432591
D6RA6	432590

<b>TC</b>	<b>Valeo NEW</b>
D6RA7	432586
D6RA8	432588
D6RA10	432598
D6RA11	594100
D6RA12	432593
D6RA13	432594
D6RA15	432586
D6RA16	432596
D6RA17	594081
D6RA18	432588
D6RA19	594082
D6RA20	432598
D6RA21	432599
D6RA22	594085
D6RA23	432592
D6RA25	432604
D6RA26	432603
D6RA27	594090
D6RA28	432602
D6RA29	594091
D6RA30	432601
D6RA32	432626
D6RA33	432622
D6RA34	594082
D6RA37	432623
D6RA38	432624
D6RA39	432650
D6RA40	594100
D6RA41	432631
D6RA42	432557
D6RA43	432558
D6RA44	432559
D6RA46	432628
D6RA47	432508
D6RA50	594082
D6RA51	432633
D6RA52	594085
D6RA53	432638
D6RA54	432681
D6RA55	432635
D6RA56	432628
D6RA57	432623
D6RA59	432643
D6RA60	594081
D6RA61	432590

<b>TC</b>	<b>Valeo NEW</b>
D6RA62	432632
D6RA63	432670
D6RA64	432592
D6RA66	432596
D6RA67	438015
D6RA68	432675
D6RA70	455956
D6RA72	432593
D6RA73	438016
D6RA74	438092
D6RA75	432635
D6RA76	432673
D6RA78	438017
D6RA79	438018
D6RA80	438070
D6RA81	438071
D6RA82	438014
D6RA83	438079
D6RA84	438029
D6RA87	438089
D6RA91	438132
D6RA93	438183
D6RA100	438086
D6RA101	455936
D6RA104	438074
D6RA105	438112
D6RA107	438087
D6RA108	438094
D6RA109	438091
D6RA110	438133
D6RA114	438197
D6RA115	438112
D6RA133	432622
D6RA137	438111
D6RA138	438145
D6RA141	432631
D6RA162	432632
D6RA163	432632
D6RA167	438082
D6RA168	432675
D6RA169	432665
D6RA180	438083
D6RA181	438084
D6RA185	438029
D6RA187	438111

<b>TC</b>	<b>Valeo NEW</b>
D6RA188	438145
D6RA190	438207
D6RA210	432599
D6RA249	432632
D6RA293	438183
D6RA421	432557
D6RA431	432558
D6RA441	432559
D6RA511	432633
D6RA571	432623
D6RA572	432623
D6RA661	432636
D6RA721	432593
D6RA811	438023
D6RAD183	438146
D7E1	432685
D7E4	438027
D7E5	438028
D7E6	438054
D7E8	438027
D7E15	438081
D7E16	438093
D7E18	438027
D7E19	438110
D7E20	438081
D7E22	438054
D7E23	438129
D7E26	438134
D7E27	438163
D7E29	438135
D7E30	438136
D7E31	438137
D7E32	438156
D7E38	438027
D7E39	432685
D7E40	438136
D7E41	438137
D7E42	438156
D7E47	438163
D7E52	438144
D7E62	432663
D7ED28	438147
D7ED281	438147
D7G3	438166
D7G4	438151

<b>TC</b>	<b>Valeo NEW</b>
D7G6	438161
D7G11	438170
D7G13	438188
D7G14	438191
D7G15	438196
D7G18	438195
D7G26	438189
D7GS7	438164
D7GS8	438175
D7GS9	438184
D7GS10	438176
D7GS17	438167
D7R1	432613
D7R2	432639
D7R3	432613
D7R4	432630
D7R5	432582
D7R7	438053
D7R8	432630
D7R9	432668
D7R11	432613
D7R12	432667
D7R13	432637
D7R14	438012
D7R15	432666
D7R16	432674
D7R17	438011
D7R18	432684
D7R19	432644
D7R20	438030
D7R22	438019
D7R23	438025
D7R24	438013
D7R25	432672
D7R26	438068
D7R27	438069
D7R28	432644
D7R33	438072
D7R34	438085
D7R35	432672
D7R36	438078
D7R37	438157
D7R39	438160
D7R40	438088
D7R41	439638

<b>TC</b>	<b>Valeo NEW</b>
D7R42	438053
D7R43	432644
D7R44	438090
D7R46	432644
D7R47	438095
D7R48	438096
D7R49	438095
D7R53	438158
D7R53d	438158
D7R56	438085
D7R57	438186
D7R61	438169
D7R64	438148
D7R65	438199
D7R70	438065
D7R151	432666
D7R281	438215
D7RS29	438075
D7RS30	438076
D7RS31	438077
D7RS50	438152
D7RS129	438075
D7RS130	438076
D7RS131	438077
D7RS150	438152
D7RS291	438205
D7RS301	438206
D8R1	438162
D8R27	438165
D8R28	438200
D8R29	438193
D8R39	438187
D8R49	438201
D9E20	97820
D9E31	432556
D9E32	432556
D9E36	433223
D9E38	432544
D9E39	432566
D9E43	432545
D9E44	432545
D9E54	432512
D9E55	432547
D9E57	432511
D9E61	432512

<b>TC</b>	<b>Valeo NEW</b>
D9E62	432512
D9E64	432551
D9E70	432555
D9E76	432566
D9E78	432565
D9E82	432556
D9E83	432545
D9E85	432554
D9E86	432555
D9E102	432579
D9E103	183054
D9E104	432562
D9E111	432656
D9E130	594209
D9E131	432545
D9E132	432611
D9E136	432606
D9E137	432614
D9E138	432621
D9E140	432605
D9E238	432621
D9E701	432555
D9E771	432581
D9E772	432510
D9E773	433249
D9E774	432510
D9E776	432581
D9E851	432554
D9E852	432554
D9E861	432555
D9R73	432538
D9R84	432561
D9R89	432536
D9R90	432563
D9R91	432574
D9R96	105808
D9R97	432587
D9R99	432577
D9R105	432529
D9R106	432530
D9R112	432629
D9R116	184202
D9R118	432537
D9R119	432627
D9R121	432595

<b>TC</b>	<b>Valeo NEW</b>
D9R134	432580
D9R135	432609
D9R139	432612
D9R142	432639
D9R144	184202
D9R149	432644
D9R1050	432608
D13HP601	438010
D13HP605	594215
D13HP607	594213
D13HP608	438050
D13HP609	438020
D13HP613	438009
D13HP702	438106
D13HP703	594216
D13HP704	438026
D13HP705	438139
D13HP709	438009
FG9T011	439763
FG9T012	439787
FG15T030	439766
FG15T036	439679
FG15T044	439759
FG15T050	439803
FG15T056	439808
FG15T057	439834
FG15T072	439759
FG15T079	439820
FG18D024	439652
FG18D037	439722
FG18D057	439708
FG18D111	439802
FG18S011	439668
FG18S012	439653
FG18S013	439618
FG18S014	439675
FG18S016	439649
FG18S017	439620
FG18S019	439613
FG18S022	439630
FG18S023	439631
FG18S027	439690
FG18S029	439741
FG18S032	439739
FG18S036	439639

<b>TC</b>	<b>Valeo NEW</b>
FG18S039	439715
FG18S040	439682
FG18S043	439681
FG18S044	439812
FG18S045	439793
FG18S046	439717
FG18S047	439704
FG18S048	439698
FG18S052	439709
FG18S056	439744
FG18S060	439732
FG18S061	439762
FG18S066	439811
FG18S073	439712
FG18S077	439738
FG18S078	439769
FG18S083	439745
FG18S093	439797
FG18S095	439779
FG18S097	439865
FG18S098	439772
FG18S099	439773
FG18S100	439777
FG18S108	439630
FG18S109	439631
FG18S110	439823
FG18S127	439819
FG18S128	439818
FG18S130	439836
FG18S133	439896
FG18S134	439919
FG18S135	439884
FG18S138	439871
FG18S141	439879
FG18T033	439667
FG18T041	439686
FG18T042	439687
FG18T051	439718
FG18T062	439751
FG18T063	439710
FG18T070	439735
FG18T071	439713
FG18T072	439750
FG18T074	439736
FG18T079	439783

<b>TC</b>	<b>Valeo NEW</b>
FG18T084	439737
FG18T094	439784
FG18T101	439835
FG18T106	439897
FG18T112	439779
FG18T115	439751
FG18T117	439736
FG18T118	439667
FG18T119	439837
FG18T120	439838
FG18T121	439839
FG18T122	439840
FG18T123	439783
FG20S011	439781
FG20S014	439771
FG20S015	439798
FG20S016	439799
FG20S017	439795
FG20S018	439800
FG20S019	439867
FG20S022	439888
FG23S010	439636
FG23S011	439670
FG23S012	439765
FG23S013	439688
FG23S021	439689
FG23S022	439641
FG23S025	439684
FG23S026	439893
FG23S027	439743
FG23S028	439685
FG23S031	439716
FG23S032	439730
FG23S033	439788
FG23S035	439756
FG23S039	439742
FG23S040	439810
FG23S041	439794
FG23S043	439636
FG23S044	439699
FG23S046	439749
FG23S048	439770
FG23S049	439740
FG23S054	439636
FG23S057	439774

<b>TC</b>	<b>Valeo NEW</b>
FG23S058	439731
FG23S059	439830
FG23S061	439756
FG23S062	439813
FG23S063	439789
FG23S065	439816
FG23S066	439817
FG23S068	439833
FG23S073	439856
FG23S074	439857
FG23S075	439858
FS10E3b	438163
FS10E10	438228
FS10E10b	438228
SG7S010	439226
SG7S012	439429
SG7S013	439430
SG7S014	439246
SG7S015	439275
SG7S016	439494
SG7S020	439453
SG7S021	439454
SG7S024	439246
SG7S026	439499
SG7S028	439308
SG7S070	439429
SG7S071	439430
SG7S074	439308
SG8B010	439264
SG8B011	439310
SG8B013	439436
SG8B015	439437
SG8B016	439438
SG8B017	439439
SG8B018	439440
SG8B020	439247
SG8B021	439277
SG8B022	439495
SG8B023	439452
SG8B026	439482
SG8B027	439436
SG8B029	439437
SG9B010	439338
SG9B011	439261
SG9B013	439311

<b>TC</b>	<b>Valeo NEW</b>
SG9B015	439441
SG9B017	437340
SG9B018	439442
SG9B019	439443
SG9B023	439444
SG9B024	439445
SG9B025	439295
SG9B027	439262
SG9B029	439397
SG9B033	439306
SG9B035	439417
SG9B037	439206
SG9B038	439232
SG9B039	439333
SG9B040	439418
SG9B042	439327
SG9B048	439451
SG9B049	439311
SG9B050	439418
SG9B052	439496
SG9B053	439467
SG9B054	439472
SG9B055	439461
SG9B057	439481
SG9B059	439311
SG9B063	439277
SG9B064	439495
SG9B066	439277
SG9B067	439495
SG9B069	439444
SG9B077	439023
SG9B078	439441
SG9B079	439544
SG9B087	439311
SG9B088	439311
SG9B089	439467
SG9B095	439442
SG9B107	439417
SG9B108	439467
SG9B121	439544
SG10B010	439267
SG10B011	439266
SG10B013	439309
SG10B014	439309
SG10B016	439318

<b>TC</b>	<b>Valeo NEW</b>
SG10B018	439315
SG10B019	439319
SG10B020 SP	439313
SG10B021	439248
SG10B022	439276
SG10B023	439449
SG10B031	439266
SG10B032	439480
SG10B035	439266
SG10B048	439553
SG10B079 SP	439872
SG11B010	439484
SG12B010	439271
SG12B011	439265
SG12B012	439328
SG12B015	437317
SG12B016	439272
SG12B017	439292
SG12B018	439263
SG12B020	437308
SG12B021	439296
SG12B022	439297
SG12B023	439298
SG12B024	439307
SG12B025	439260
SG12B027	439299
SG12B028	439300
SG12B029	439398
SG12B030	439464
SG12B039	439317
SG12B040	439339
SG12B041	439316
SG12B042	439326
SG12B044	439419
SG12B045	439321
SG12B047	439395
SG12B049	439328
SG12B050	439341
SG12B052	439478
SG12B054	439391
SG12B055	439394
SG12B060	439420
SG12B062	439471
SG12B063	439468
SG12B065	439419

<b>TC</b>	<b>Valeo NEW</b>
SG12B068	439464
SG12B071	439292
SG12B072	439464
SG12B074	439462
SG12B075	439395
SG12B080	439301
SG12B081	439478
SG12B082	439468
SG12B087	439540
SG12B089	439562
SG12B090	439312
SG12B092	439587
SG12B095	439341
SG12B096	439292
SG12B097	439464
SG12B098	439478
SG12B103	440028
SG12B105	439584
SG12B107	439464
SG12B108	439341
SG12B109	439478
SG12B110	439292
SG12B116	439341
SG12B122	439464
SG12B123	439292
SG12B124	439587
SG12B127	439669
SG12S019	439470
SG12S073	439469
SG14B010	439393
SG14B011	439421
SG14B012	439392
SG14B013	439460
SG14B016	439393
SG14B017	439476
SG14B019	439507
SG14B020	439507
SG14B022	439393
SG15L012	439455
SG15L020	439474
SG15L023	439571
SG15L026	439455
SG15L027	439474
SG15L033	439571
SG15L034	439474

<b>TC</b>	<b>Valeo NEW</b>
SG15L035	439474
SG15L036	439571
SG15S010	439340
SG15S016	439257
SG15S017	439477
SG15S018	439294
SG15S019	439473
SG15S021	439257
SG15S022	439294
SG15S024	439493
SG15S025	439447
SG15S030	439463
SG15S031	439492
SG15S032	439340
SG15S037	437432
TG7S010	439275
TG7S011	439494
TG7S012	439589
TG7S013	439494
TG7S014	439691
TG7S017	440063
TG8C011	439490
TG8C018	439550
TG8S010	439506
TG8S012	439504
TG8S013	439523
TG8S014	439523
TG8S016	439523
TG8S017	439230
TG8S019	439550
TG8S021	439506
TG8S022	439504
TG8S023	439523
TG8S024	439595
TG8S025	439230
TG9B024	439277
TG9B025	439495
TG9B026	439568
TG9B028	439573
TG9B042	439625
TG9B043	439495
TG9B044	439568
TG9B045	439573
TG9B047	439661
TG9B049	439635

<b>TC</b>	<b>Valeo NEW</b>
TG9B052	439676
TG9B053	439661
TG9B064	439692
TG9B065	439693
TG9B066	439694
TG9B067	439695
TG9B068	439703
TG9B107	439832
TG9C013	439488
TG9C095	439488
TG9S010	439505
TG9S011	439539
TG9S015	439524
TG9S016	439524
TG9S021	439524
TG9S022	439524
TG9S027	439615
TG9S036	439505
TG9S037	439654
TG9S038	439524
TG9S039	439539
TG9S040	439615
TG9S060	439706
TG9S063	439524
TG9S100	439786
TG10B013	439553
TG10B024	439553
TG10B025	439659
TG11C010	439479
TG11C011 SP	439475
TG11C014	439511
TG11C015	439491
TG11C016	439500
TG11C017	439501
TG11C022	439479
TG11C024	439295
TG11C027	439578
TG11C034	439561
TG11C035	439551
TG11C036	439538
TG11C040	439588
TG11C041	439593
TG11C048	439580
TG11C049	439479
TG11C054	439592

<b>TC</b>	<b>Valeo NEW</b>
TG11C055	439591
TG11C056	439596
TG11C057	439637
TG11C059	439538
TG11C060	439591
TG11C061	439479
TG11C063	439578
TG11C064	439561
TG11C065	439588
TG11C066	439593
TG11C067	439752
TG11C068	439596
TG11C069	439593
TG11C073	439666
TG11C074	439551
TG11C086	439733
TG11C094	439755
TG11C095	439754
TG11C096	439719
TG11C131	439859
TG12C013	439483
TG12C015	439533
TG12C016	439569
TG12C026	439611
TG12C033	439607
TG12C037	439612
TG12C038	439632
TG12C039	439623
TG12C059	439617
TG12C062	439648
TG12C063	439678
TG12C077	439662
TG12C078	439677
TG12C087	439612
TG12C090	439683
TG12C091	439807
TG12C092	439790
TG12C094	439680
TG12C106	439758
TG12C107	439899
TG12C109	437448
TG12C110	437524
TG12C113	439874
TG12C118	439760
TG12C120	439617

<b>TC</b>	<b>Valeo NEW</b>
TG12C124	439829
TG12C125	439815
TG12C139	439875
TG12C140	439683
TG12C141	439760
TG12C150	439677
TG12C151	439680
TG12C198	439807
TG12C199	439790
TG12S101	439707
TG12S111	439780
TG12S128	439796
TG14C011	439489
TG14C012	439563
TG14C014	439556
TG14C015	439534
TG14C016	439489
TG14C018	439657
TG14C019	439792
TG14C020	439642
TG14C022	439643
TG14C023	439608
TG14C025	439822
TG14C026	439664
TG14C027	439665
TG14C028	439720
TG14C031	439724
TG14C034	439753
TG14C035	439721
TG14C036	439734
TG14C037	439725
TG14C039	439768
TG14C040	439806
TG14C041	439814
TG14C042	439643
TG14C043	439791
TG14C044	439764
TG14C046	439892
TG14C047	439776
TG14C049	439821
TG14C054	439850
TG14C055	439851
TG14C056	439831
TG14C057	439852
TG14C058	439853

<b>TC</b>	<b>Valeo NEW</b>
TG14C059	439854
TG14C060	439855
TG14C067	439860
TG14C068	439862
TG14C071	439894
TG15C012	439487
TG15C015	439470
TG15C017	439498
TG15C018	439486
TG15C018b	439486
TG15C020	439502
TG15C022	439503
TG15C023	439492
TG15C027	439545
TG15C027b	439545
TG15C028	439502
TG15C038	439459
TG15C043	439574
TG15C053	439502
TG15C054	439503
TG15C057B	439552
TG15C057C	439552
TG15C058	439576
TG15C060	439655
TG15C064	439567
TG15C065	439498
TG15C072	439621
TG15C073	439600
TG15C075	439610
TG15C091	439577
TG15C093	439545
TG15C094	439658
TG15C095	439644
TG15C098	439590
TG15C103	439633
TG15C112	439622
TG15C117	439470
TG15C118	439502
TG15C119	439503
TG15C120	439634
TG15C121	439552
TG15C123	439627
TG15C124	439628
TG15C125	439577
TG15C127	439626

<b>TC</b>	<b>Valeo NEW</b>
TG15C128	439647
TG15C130	439671
TG15C131	439672
TG15C133	439679
TG15C134	439674
TG15C135	439701
TG15C137	439663
TG15C141	439628
TG15C142	439922
TG15C143	439645
TG15C144	439656
TG15C145	439535
TG15C146	439646
TG15C148	439911
TG15C149	439748
TG15C152	439916
TG15C154	439697
TG15C156	439696
TG15C157	439723
TG15C165	439700
TG15C177	439782
TG15C181	439757
TG15C182	439746
TG15C189	439701
TG15C190	439775
TG15C194	439804
TG15C195	439920
TG15C196	439782
TG15C200	439887
TG15S205	439701
TG16C010	439535
TG16C011	439564
TG16C012	439548
TG16C013	439557
TG16C014	439581
TG17C010	439485
TG17C010b	439485
TG17C011	439559
TG17C016	437564
TG17C016b	439565
TG17C019	439558
TG17C020	439527
TG17C021	439510
TG17C021b	439510
TG17C022	439541

<b>TC</b>	<b>Valeo NEW</b>
TG17C023	439536
TG17C024	439549
TG17C026	439579
TG17C027	439537
TG17C027b	439537
TG17C028	439546
TG17C030	439546
TG17C030b	439546
TG17C032	439583
TG17C034	439605
TG17C035	439566
TG17C036	439601
TG17C039	439624
TG17C040	439582
TG17C041	439585
TG17C044	439554
TG17C048	439485
TG17C054	439549
TG17C061	439619
TG17C062	439650
TG17C065	439582
TG17C072	437507
TG23C011	439602
TG23C012	439606
TG23C013	439603
TG23C017	439597
TG23C018	439640
TG23C019	439609
TG23C022	439599
TG23C033	439640
TG23C034	439801
TG23C035	439809
TS8E2	438093
TS8E3	438136
TS8E4	438137
TS8E5	438156
TS8E6	432685
TS8E6(B)	432685
TS10E1	438192
TS10E3	438163
TS10E4	438110
TS10E5	438054
TS10E5(B)	438054
TS10E11	438312
TS12-77	438294





<b>TC</b>	<b>Valeo NEW</b>
TS12E30	438177
TS12E36	438272
TS12E200	438311
TS12E901	438285
TS12E902	438286
TS12E9(b)	438224
TS12ER15	438273
TS12ER15M	438273
TS12ER19	438268
TS12ER20	438219
TS12ER22	438262
TS12ER22M	438262
TS12ER25	438238
TS14E6	438266
TS14E7	438264
TS14E16	438267
TS14E17	438265
TS14E110	438133
TS14E42	438239
TS18E1(b)	438175
TS18E3(b)	438176
TS18E7	438213
TS18E13	438166
TS18E33	438212
TS18E331	438212
TS18ER20(b)	438227
TS18ER21	438287
TS18ER22	438252
TS18ER23	438281
TS18ER121(b)	438225
TS18ER123	438226
TS18ER123(b)	438226
TS22-31	438314
TS22-32	438315
TS22-33	438316
TS22E5	438202
TS22E8(C)	438263
TS22E20	438274
TS22E26	438189
TS22E45	438232
TS22ER12	438243
TS22ER13	438243
TS24E2(A)	438223
TS24E3	438220
TS24E6	438256



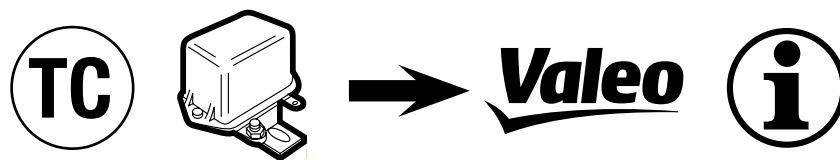

<b>TC</b>	<b>Valeo NEW</b>
TS24E7	438255
TS24E13	438231
TS24E30	438271

















 			
9RC2021	523190	14	INC
9RC7141	593884	14	INC
COM VDA	599251	14	INC
COM VDA	599249	14	INC
COM VDA	599350	14	INC
COM VDA	599326	14	INC
RC9101	593362	14	INC
RC9101	593551	14	INC
YM	593970	14	INC
YM	593975	14	INC
YM	595243	14	INC
YM194	593131	14	INC
YM36 9RC7176	593333	14	INC
YM36 9RC7176	593423	14	INC
YM1413	593310	14	INC
YM1476P	593389	14	INC
YM1600	593290	14	INC
YM1601T	593141	14	INC
YM1606P1	593318	14	INC
YM16106P	593550	14	INC
YM1615P1	593303	14	INC
YM1619P1	593319	14	INC
YM1658	593434	14	INC
YM1662P	593411	14	INC
YM1669P	593505	14	INC
YM1689	593779	14	INC
YM1689PF	593666	14	INC
YM2621P2	593342	14	INC
YM3617P1C	599145	14	INC
YM3617P1C	599146	14	INC
YM3617P1C	599147	14	INC
YM3618P1C	593347	14	INC
YM3634VFP2	593406	14	INC
YM3699P1C	593839	14	INC
YM369RC7176	593846	14	INC
YM46104P	593818	14	INC
YM6603	593284	14	INC
YM6663PF	593498	14	INC
YM6670VF	593419	14	INC
YM6951	593138	14	INC
YM6952	593350	14	INC
YM6956	593375	14	INC
YM9980	593139	14	INC
YM10607P	593305	14	INC
YM66101PF	593845	14	INC

 			
YR COM	593948	14	INC
YR COM	593984	14	INC
YR COM	595237	14	INC
YR COM	595238	14	INC
YR COM	595294	14	INC
YR COM	595457	14	INC
YR COM	595458	14	INC
YR COM	595464	14	INC
YR COM	599062	14	INC
YR COM	599065	14	INC
YR COM	599088	14	INC
YR COM	599107	14	INC
YR COM	599131	14	INC
YR COM	599149	14	INC
YR COM	599162	14	INC
YR COM	599191	14	INC
YR COM	599199	14	INC
YR COM	599221	14	INC
YR COM	599259	14	INC
YR COM	599261	14	INC
YR COM VDA	599125	14	INC
YR COM VDA	599127	14	INC
YR COM VDA	599141	14	INC
YR COM VDA	599183	14	INC
YR COM VDA	599212	14	INC
YR COM VDA	599213	14	INC
YR COM VDA	599215	14	INC
YR COM VDA	599217	14	INC
YR COM VDA	599228	14	INC
YR COM VDA	599249	14	INC
YR COM VDA	599251	14	INC
YR COM VDA	599270	14	INC
YR COM VDA	599277	14	INC
YR COM VDA	599283	14	INC
YR COM VDA	599288	14	INC
YR COM VDA	599296	14	INC
YR COM VDA	599297	14	INC
YR COM VDA	599300	14	INC
YR COM VDA	599301	14	INC
YR COM VDA	599304	14	INC
YR COM VDA	599306	14	INC
YR COM VDA	599322	14	INC
YR COM VDA	599324	14	INC
YR CPLE	593546	14	INC
YR CPLE	593936	14	INC

 			
YR CPLE	593937	14	INC
YR CPLE	593939	14	INC
YR CPLE	595283	14	INC
YR VDA	599083	14	INC
YR VDA	599239	14	INC
YR VDA	599317	14	INC
YR025	599121	14	INC
YR025	599123	14	INC
YR025 PCM	593675	14	INC
YR027	599160	14	INC
YR027	599269	14	INC
YR 223	599232	14	INC
YR208	595339	14	INC
YR66	593915	14	INC
YR123	599150	14	INC
YR123	599197	14	INC
YR123	599204	14	INC
YR124	593536	14	INC
YR124	595252	14	INC
YR124	595253	14	INC
YR124	595336	14	INC
YR124	595379	14	INC
YR124	595411	14	INC
YR124	595416	14	INC
YR124	595450	14	INC
YR124	599173	14	INC
YR124 COM	593873	14	INC
YR124 COM	595334	14	INC
YR124 COM	595348	14	INC
YR124 COM	595446	14	INC
YR124 COM	599095	14	INC
YR124 COM	599101	14	INC
YR124 COM	599102	14	INC
YR124 COM	599154	14	INC
YR133	599294	14	INC
YR133 COM VDA	599233	14	INC
YR133 COM VDA	599234	14	INC
YR133 COM VDA	599235	14	INC
YR133 COM VDA	599236	14	INC
YR133 COM VDA	599237	14	INC
YR133 COM VDA	599238	14	INC
YR133 COM VDA	599241	14	INC
YR133 COM VDA	599302	14	INC
YR133 COM VDA	599303	14	INC

 			
YR133 COM VDA	599305	14	INC
YR143	599260	14	INC
YR143	599271	14	INC
YR208	593529	14	INC
YR208	593532	14	INC
YR208	593534	14	INC
YR208	593773	14	INC
YR208	593940	14	INC
YR208	593941	14	INC
YR208	593942	14	INC
YR208	593944	14	INC
YR208	593945	14	INC
YR208	593967	14	INC
YR208	593993	14	INC
YR208	595229	14	INC
YR208	595324	14	INC
YR208	595354	14	INC
YR208	595366	14	INC
YR208	595389	14	INC
YR208	595452	14	INC
YR208	595478	14	INC
YR208	599128	14	INC
YR208	599224	14	INC
YR208	599316	14	INC
YR223	595497	14	INC
YR223	599053	14	INC
YR223	599096	14	INC
YR223	599159	14	INC
YR223	592142	14	INC
YR223	595327	14	INC
YR223 COM	595387	14	INC
YR223 VDA	599140	14	INC
YR223 VDA	599203	14	INC
YR223 VDA	599342	14	INC
YR233	599182	14	INC
YR233	599187	14	INC
YR233	599210	14	INC
YR233	599240	14	INC
YR36 CPLE	593793	14	INC
YR3647P	593966	14	INC
YR1615PF	593689	14	INC
YR1615PF	593935	14	INC
YR1615PF	593938	14	INC
YR1645VP1	593828	14	INC





Every effort has been made to ensure that the information contained in this catalogue is correct at the time of printing, but no warranty or representation is given or made as to the accuracy of such information and Valeo Service UK Ltd does not accept any liability whatsoever for any inaccuracies.

Valeo Service UK Ltd reserves the right to alter specifications and/or the final construction of products without notice.

L'affectation et la préconisation des produits figurant dans nos catalogues prennent en compte l'état du parc automobile au jour de leur parution.

La responsabilité de Valeo Service ne saurait être engagée en cas de modification, substitution ou suppression des affectations ou préconisations qui pourraient intervenir notamment à l'initiative des constructeurs de véhicules.

Les caractéristiques techniques de nos produits sont susceptibles d'évoluer à tout moment pour tenir compte des améliorations techniques et technologiques.

La aplicación de los productos sobre vehículos y las especificaciones de los productos que figuran en nuestros catálogos se refieren a la situación del parque de automóviles en la fecha de puesta en circulación de los productos.

Valeo Service España SA no asume ninguna responsabilidad en caso de modificación, sustitución o supresión de dichas aplicaciones y/o especificaciones que pudieran producirse por iniciativa de los fabricantes de automóviles.

Las características técnicas de nuestros productos son susceptibles de evolucionar en cualquier momento para incorporar las mejoras técnicas y tecnológicas que se desarrollen.

As prescrições e recomendações relativas ao uso ou utilidade dos produtos constantes de nossos catálogos levam em consideração o estado do parque automotivo à época do lançamento desses produtos.

A Valeo Sistemas Automotivos Ltda (Valeo Cibié Service) não será responsável por quaisquer modificações, substituições ou supressões incidentes sobre as prescrições e recomendações relativas ao uso ou utilidade de nossos produtos, que sejam decorrentes de ações dos construtores de veículos.

As características técnicas de nossos produtos são suscetíveis de alteração a qualquer momento para que sejam incorporadas melhorias técnicas e/ou tecnológicas.

Le applicazioni e le specifiche dei prodotti che figurano nei nostri cataloghi si riferiscono alla situazione del parco circolante al momento della pubblicazione.

Valeo Service Italia S.p.A. declina qualsiasi responsabilità in caso di modifica, sostituzione o soppressione di applicazioni o specifiche eventualmente apportate, senza preavviso, da parte dei Costruttori.

Le caratteristiche tecniche dei nostri prodotti sono suscettibili di modifiche in qualsiasi momento, per apportare migliorie tecniche e tecnologiche.

De ter zake van de producten in onze catalogi aangegeven bestemmingen en gedane aanbevelingen zijn gebaseerd op het wagenpark ten tijde van publicatie.

Valeo Service Benelux B.V. sluit elke aansprakelijkheid uit met betrekking tot wijziging, vervanging of annulering van de bestemmingen of aanbevelingen, die met name op initiatief van de autofabrikanten kunnen worden doorgevoerd.

De technische eigenschappen van onze producten kunnen te allen tijde evolueren teneinde rekening te houden met technische en technologische verbeteringen.

Die Verwendungsempfehlungen zu den in diesem Katalog aufgeführten Produkten beziehen sich auf den zum Zeitpunkt des Erscheinens dieses Katalogs existierenden Fahrzeugbestand.

Valeo Service Deutschland GmbH übernimmt keine Haftung für Änderungen, Ersetzungen oder Streichungen der Fahrzeuganwendung oder -Empfehlungen, die besonders auf Initiative der Fahrzeughersteller auftreten können.

Die technischen Eigenschaften unserer Produkte unterliegen ständiger Entwicklung, um technischen und technologischen Verbesserungen Rechnung zu tragen.

Przeznaczenie i zalecenia dotyczące produktów figurujących w naszych katalogach biorą pod uwagę stan parku samochodowego w dniu ich wprowadzenia na rynek.

Firma «Valeo Service Eastern Europe Sp. z o.o.» nie może ponosić odpowiedzialności w przypadku zmiany, zastąpienia lub usunięcia wskazówek dotyczących przeznaczenia produktu i zaleceń, które mogą wystąpić z inicjatywy producentów samochodów.

Dane techniczne naszych produktów mogą być w każdej chwili zmienione w celu uwzględnienia ulepszeń technicznych i technologicznych.

Kataloglarımızda yer alan ürünlerin kullanım ve tanımları, otomobil parkının yaygın tarihindeki durumuna göredir.

Valeo Otomotiv Dağıtım AS, özellikle araç, üreticilerinin inisiyatifli sonucunu yapılan değişiklik, ikame veya kaldırılmaları sorumlu tutulamaz.

Ürünlerimizin teknik özellikleri, teknik ve teknolojik gelişmelere paralel olarak geliştirilebilir.

Назначение и рекомендации по эксплуатации продукции, содержащиеся в наших каталогах, указываются с учетом состояния автомобильного парка на день ее появления.

Компания «Valeo Service Eastern Europe Sp.zo.o» не несет ответственности в случае внесения изменений в рекомендации по эксплуатации продукции или их устранения, произошедших, в частности, по инициативе производителей автомобилей.

Технические характеристики нашей продукции могут претерпевать изменения в любой момент, с учетом совершенствования технических и технологических процессов.

O catálogoс έχει συσταθεί λαμβάνοντας υπόψη τη σύσταση του στόλου αυτοκινήτων την ημέρα, της κυκλοφορίας του.

H Valeo δε φέρει ευθύνη σε περίπτωση τροποποίησης, αλλαγής ή αντικατάστασης κάποιου αντ/κου που περιέχεται στο κατάλογο, εξαιτίας πρωτοβουλίας του κατασκευαστή του οχήματος.

Τα τεχνικά χαρακτηριστικά των προϊόντων ενδέχεται να διαφοροποιηθούν ανά πάσα στιγμή λόγω τεχνολογικών εξελίξεων.

Μερικοί κωδικοί αντ/κων μπορεί να μην είναι διαθέσιμοι σε κάποιες χώρες.

Product references referred to in this catalogue may not be available in all countries.

All orders for products are only accepted subject to the terms and conditions of Valeo Service UK Ltd.

Photographs and drawings are not binding on Valeo Service UK Ltd. The copyright in this publication belongs to Valeo Service UK Ltd exclusively. No part of this publication may be reproduced by any means without the prior authorisation of Valeo Service UK Ltd.

Certaines références peuvent ne pas être disponibles dans tous les pays.

Les commandes sont régies par les conditions générales de vente de Valeo Service.

Photos et dessins non contractuels. La reproduction de tout ou partie de cette publication est interdite sans l'autorisation expresse et écrite de Valeo Service.

Las referencias de productos mencionadas en este catalogo puede que no estén disponibles en todos los países.

Los pedidos se regiran por las condiciones generales de venta de Valeo Service España SA.

Las fotografías y dibujos que aparecen en nuestros catálogos son meramente indicativas, por lo que no siempre coinciden exactamente con la apariencia externa de nuestros productos. Se prohíbe la reproducción de todo o parte de esta publicación sin la autorización expresa y escrita de Valeo Service España SA.

Certas referências podem não estar disponíveis em todos os países.

Os pedidos feitos pelos clientes são regidos pelas condições gerais de venda da Valeo Sistemas Automotivos Ltda (Valeo Cibié Service).

Fotos e desenhos não contratuais. A reprodução do todo ou de parte desta publicação é proibida sem a autorização expressa e por escrito da Valeo Sistemas Automotivos Ltda (Valeo Cibié Service).

Alcuni riferimenti presenti in questo catalogo non sono disponibili in tutti i paesi.

Gli ordini sono regolamentati dalle condizioni generali di vendita di Valeo Service Italia S.p.A.

Le Foto ed i disegni che appaiono nel catalogo sono puramente indicativi. E' vietata la riproduzione della totalità o di una parte della presente pubblicazione senza un'esplicita autorizzazione scritta da parte di Valeo Service Italia S.p.A.

Bepaalde artikelen kunnen in bepaalde landen niet beschikbaar zijn.

Orders zijn onderworpen aan de algemene verkoopvoorwaarden van Valeo Service Benelux B.V.

Foto's en tekeningen zijn niet bindend.

De gehele of gedeeltelijke verveelvoudiging van deze uitgave zonder uitdrukkelijke voorafgaande schriftelijke toestemming van Valeo Service Benelux B.V. is verboden.

Die Fotos oder Zeichnungen in diesem Katalog dienen ausschliesslich der Veranschaulichung unserer Produkte. Rechtliche Ansprüche können daraus nicht abgeleitet werden.

Einige Produktreferenzen sind nicht in allen Ländern verfügbar.

Lieferungen unterliegen den Allgemeinen Verkaufsbedingungen von Valeo Service Deutschland GmbH.

Die Vervielfältigung dieses Katalogs oder Teilen davon ohne die schriftliche Erlaubnis von Valeo Service Deutschland GmbH ist nicht zulässig.

Niektóre modele mogą być niedostępne w niektórych krajach.

Zamówienia podlegają ogólnym warunkom umów «Valeo Service Eastern Europe Sp. z o.o.».

Wykorzystywanie w całości lub w części zdjęć i rysunków zamieszczonych w naszych katalogach wymaga pisemnej zgody «Valeo Service Eastern Europe Sp. z o.o.».

Bazı referanslar bazı ülkelerde bulunmayabilir.

Siparişler, Valeo Otomotiv Dağıtım AS'un genel satış koşullarına uygun olarak ödenir.

Fotoğraf ve resimler akdi değildir. İşbu yayının Valeo Otomotiv Dağıtım AS'un önceden verilmiş yazılı izni olmaksızın kısmen veya tamamen çoğaltılması yasaktır.

Некоторые виды продукции могут не иметься в наличии в отдельных странах.

Заказы осуществляются согласно общим правилам торговли, применяемым в компании «Valeo Service Eastern Europe Sp.zo.o».

Фотографии и изображения продукции могут не в полной мере соответствовать оригиналам. Воспроизведение всей или части настоящей публикации запрещено без специального письменного согласия компании «Valeo Service Eastern Europe Sp.zo.o».

Οι αναγγελίες υπήκεινται στους γενικούς ήρους κυλήσεων της Valeo.

Οι φωτογραφίες και τα σχέδια δεν είναι δεσμευτικά. Η αναπαραγωγή ολκλήρου ή τμήματος αυτού του καταλόγου αναγορεύεται να γίνει χωρίς τη ρητή και γραπτή άδεια της Valeo Service.

## EUROPE

### FRANCE

**VALEO SERVICE FRANCE**  
70, RUE PLEYEL  
93285 SAINT-DENIS CEDEX - FRANCE  
TEL.: (+33) 1 49 45 32 32  
FAX: (+33) 1 49 45 37 36  
S.A.S. au capital de 12 900 000 €  
RCS Bobigny B 306 486 408

### SPAIN, PORTUGAL

**VALEO SERVICE ESPAÑA, S.A.U.**  
CALLE RIO ALMANZORA, N°5  
AREA EMPRESARIAL ANDALUCIA C.L.A.  
28906 GETAFE (MADRID) - ESPAÑA  
TEL.: (+34) 91 495 85 00  
FAX: (+34) 91 495 86 99  
TEL. ATENCIÓN TÉCNICA: 902 011 799  
TEL. ATENCIÓN AL CLIENTE: 900 122 657  
Valeo Service España Sociedad Anónima  
inscrita en el Registro Mercantil de Madrid,  
Tomo 972 - Libro 941 de la sección 8ª,  
Folio 25 - Hoja 65435 - Inscripción 1ª NIF. A28772978

### ITALY, GREECE, ALBANIA, BOSNIA-HERZEGOVINA, CROATIA, CYPRUS, KOSOVO, SERBIA, SLOVENIA, MACEDONIA, MALTA, MONTENEGRO

**VALEO SERVICE ITALIA S.P.A. - ADRIATIC**  
VIA ASTI, 89  
10026 SANTENA - TORINO - ITALY  
TEL.: +39 011 9495 1  
FAX.: +39 011 9456 042  
TEL. LINEA TECNICA: 800 805 046  
N. iscrizione al Tribunale di Torino 2009/88 reg. soc.  
C.C.I.A.A. 715107 - Capitale sociale € 2.600.000

**LIAISON OFFICE IN GREECE**  
18, KALAMAKIOU AVENUE  
17455 ALIMOS - GREECE  
TEL.: +30 210 45 27 447/8  
FAX.: +30 210 45 27 449

**LIAISON OFFICE IN CROATIA**  
HEKTOROVICJEVA ULICA 2  
10000 ZAGREB - CROATIA  
TEL.: +385 1 644 8288  
FAX.: +385 1 644 1400

**LIAISON OFFICE IN SERBIA**  
19TH AVENUE GTC  
VLADIMIR POPOVICA 38-40 - 11070, NOVI  
BEOGRAD - SERBIA  
TEL: +381 (0)11 715 6976

### POLAND, LITHUANIA, LATVIA, ESTONIA, MOLDAVIA, BELARUS, UKRAINE, CZECH REPUBLIC, SLOVAKIA, HUNGARY, ROMANIA, BULGARIA

**VALEO SERVICE EASTERN EUROPE SP Z O.O.**  
WOŁOSKA 9A  
02-583 WARSAW POLSKA  
TEL.: (+48) 22 543 43 00  
FAX: (+48) 22 543 43 05  
Valeo Service Eastern Europe Sp. z o.o.; NIP 521-11-44-572  
VAT UE PL5211144572 - REGON 011909673  
Wysokość kapitału zakładowego: 4 637 000 PLN - KRS  
56793 Sąd Rejonowy dla m. St. Warszawy w Warszawie,  
XIII Wydział Gospodarczy KRS

### UNITED KINGDOM

**VALEO SERVICE UK LTD**  
HEMING ROAD - WASHFORD  
REDDITCH - WORCS B98 0DZ - ENGLAND  
TEL.: (+44) 1527 838 300  
FAX: (+44) 1527 523 732  
Registration Number: 956685

### GERMANY, SWITZERLAND, AUSTRIA

**VALEO SERVICE DEUTSCHLAND GMBH**  
BALCKE-DÜRR-ALLEE 1  
40882 RATINGEN - DEUTSCHLAND  
TEL.: (+49) 21 02 865 0  
FAX: (+49) 21 02 865 142  
TEL. HOTLINE: (+49) 800 869 2840  
Handelsregister Düsseldorf - HRB 44140

**LIAISON OFFICE IN AUSTRIA**  
MÜHLGASSE 7  
2380 PERCHTOLDSDORF - AUSTRIA  
TEL.: (+43) 1 480 42 46  
FAX: (+43) 1 480 42 34

### BENELUX, SWEDEN, FINLAND, NORWAY, DENMARK, ICELAND,

**VALEO SERVICE BENELUX B.V.**  
HEIBLOEMWEG 1  
5704 BS HELMOND - THE NETHERLANDS  
TEL. BELGIUM: 0800 39803  
TEL. NETHERLANDS: 0800 1233  
TEL. LUXEMBOURG: 0800 25909  
FAX BELGIUM: (+32) 2 366 04 47  
FAX NETHERLANDS: (+31) 492 580 828  
K.v.K. Eindhoven 33113859

**LIAISON OFFICE IN SWEDEN**  
REGUS / VALEO  
MASTER SAMUELSGATAN 60, 8TR  
SE - 111 21 STOCKHOLM - SWEDEN  
TEL.: (+46) 8 50 51 65 50

### RUSSIA

**VALEO SERVICE CO LTD**  
107140, MOSCOW  
RUSAKOVSKAYA ST. 13,  
3RD FLOOR, OFFICE 6  
TEL.: (+7) 495 981-06-96  
FAX: (+7) 495 787-59-92  
HOTLINE: 8 800 55 52 50

## NORTH AMERICA

### USA, CANADA

**VALEO SERVICE USA**  
150 STEPHENSON HWY. TROY, MI 48083-1116  
48083 TROY MICHIGAN  
TEL.: 1.248.619.8300

## SOUTH AMERICA

### SOUTH AMERICA (EXCEPT MEXICO)

**VALEO CIBIÉ SERVICE LTDA**  
**VALEO SERVICE BRAZIL**  
RUA SADAE TAKAGI, 2000  
BAIRRO COOPERATIVA  
09852-070 - SÃO BERNARDO DO CAMPO  
SÃO PAULO - BRASIL  
TEL.: (+55) 11 43 93 33 54  
FAX: (+55) 11 43 93 33 55  
C.N.P.J.: 57.010.662/0008-36  
Inscrição Estadual: 635.331.124.114

**VALEO SERVICE ARGENTINA**  
RUA SADAE TAKAGI, 2000  
BAIRRO COOPERATIVA  
09852-070 - SÃO BERNARDO DO CAMPO  
SÃO PAULO - BRASIL+  
TEL.: (+55) 11 43 93 33 54  
FAX: (+55) 11 43 93 33 55  
C.N.P.J.: 57.010.662/0008-36  
Inscrição Estadual: 635.331.124.114

### MEXICO

**VALEO SERVICE MEXICO**  
MONTECITO 38, PISO 32 OFICINA 1/2  
TORRE WORLD TRADE CENTER  
COLONIA NÁPOLES | 03810 | MÉXICO, D.F.  
TEL.: 52 (+55) 90001588

## ASIA, MIDDLE EAST

### CHINA, TAIWAN

**VALEO AUTO PART TRADING (SHANGHAI)**  
CO., LTD  
201, BUILDING B, IBC TOWER (NEW  
INTERNATIONAL BUSINESS CENTER)  
391 GUI PING ROAD, SHANGHAI 200233,  
CHINA  
TEL: (+86) 21 5175 2618  
MP: (+86) 21 5175 2628  
法雷奥汽车零部件贸易(上海)有限公司  
地址: 上海市徐汇区桂平路391号新漕河泾  
国际商务中心B座201  
电话: (+86) 21 5175 2618  
传真: (+86) 21 5175 2628

### INDIA

**VALEO SERVICE INDIA AUTO PARTS PVT.**  
**LTD.**  
(A JOINT VENTURE OF VALEO FRANCE &  
ANAND AUTOMOTIVE)  
BLOCK-A, TECCI PARK,  
173, RAJIV GANDHI SALAI (OMR)  
SHOLINGANALLUR CHENNAI - 600 119  
TEL: (+91) 44 66235000  
FAX: (+91) 44 66235011

### THAILAND, SINGAPORE, MALAYSIA, INDONESIA

**VALEO AUTOMOTIVE CO.,LTD.**  
700/424 MOO 7  
BANGNA-TRAD ROAD KM.57.  
T.DON HUA LOR,A.MUANGCHONBURI  
CHONBURI 20000, THAILAND  
TEL: +66 (0) 38 265 600  
FAX: +66 (0) 38 265 671  
Registration number: 0105539010549

### TURKEY, IRAN, IRAQ, SYRIA, LEBANON, JORDAN, SAUDI ARABIA, UNITED ARAB EMIRATES, KUWAIT, BAHRAIN, QATAR, OMAN, YEMEN, EGYPT, AZERBAIJAN, GEORGIA, ARMENIA, KAZAKHSTAN

**VALEO OTOMOTIV SISTEMLERİ ENDÜSTRİSİ**  
**A.Ş.**  
AYDINEVLER SANAYİ CADDESİ  
CENTRUM IS MERKEZİ N°302  
34854 MALTEPE  
ISTANBUL - TURKEY  
TEL.: (+90) 216 587 70 00  
FAX: (+90) 216 519 93 14

## AUSTRALIA, NEW-ZEALAND, AFRICA, DOM-TOM/ FRENCH OVERSEAS

**VALEO SERVICE AFRICA & OVERSEAS**  
70, RUE PLEYEL  
93285 SAINT-DENIS CEDEX - FRANCE  
TEL.: (+33) 1 49 45 32 32  
FAX: (+33) 1 49 45 36 59  
S.A.S. au capital de 12 900 000 €  
RCS Bobigny B 306 486 408

### LIAISON OFFICE IN TUNISIA

CENTRE D'AFFAIRES REGUS  
IMMEUBLE CARTHAGE RUE DU LAC DE  
CONSTANCE 1053 TUNIS - TUNISIA  
TEL.: (216) 71 965 002  
FAX: (216) 71 965 137  
MOB: (216)98 34 91 38

# Freewheel Pulley Turn the wheel, play Valeo!

As one of the O.E.M. worldwide leaders,  
Valeo is more than ever your Aftermarket  
specialist for Electrical Systems.



3 276429 413746

## Poulie roue libre : tournez la roue, optez pour Valeo !

Étant déjà l'un des leaders mondiaux de la machine tournante en Première Monte,  
Valeo est, avec cette gamme complémentaire, plus que jamais le spécialiste des systèmes électriques pour la Rechange Automobile.

© 2014 Valeo Service - Société par Actions Simplifiée - Capital 12.900.000 euros - 306 486 408 R.C.S. Bobigny - 70, rue Pleyel - 93200 Saint-Denis - France  
Crédits photos : Christian Schryve - Laurent Deleuze - 1001 images - Enjoy - Point 11 - Conception et impression : Zebbre - Réf. **941374** - EAN 3276429413746 - Price: 5€

\* La technologie automobile, naturellement

valeo added 

Automotive technology, naturally\*

**Valeo**